

Oval Plus Seat Benching - Typical Details

Frame Sections & Seat Options (based on typical 400mm depth for illustration purposes)

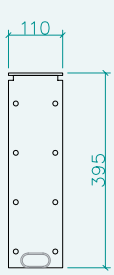

Plan View

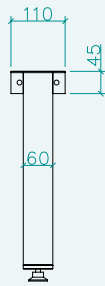

Front View

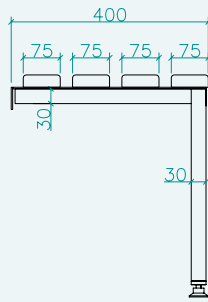

Ash Slats (Section View)

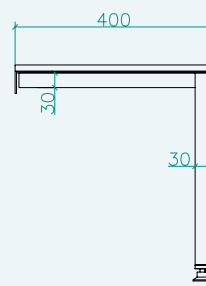

SGL Seat (Section View)

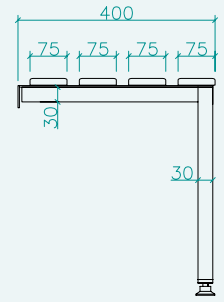

SGL Slats (Section View)

Frame Options

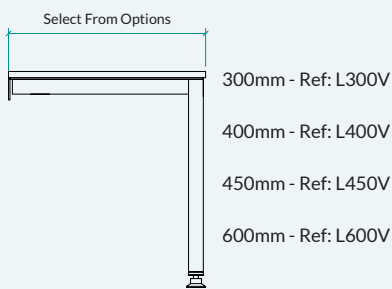

Single Wall Bench Frame

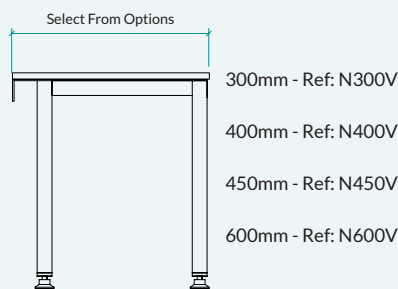

Double Leg Wall Bench Frame

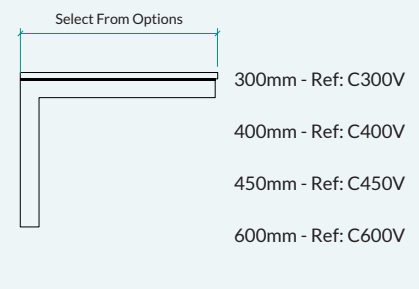

Cantilevered Wall Bench Frame

- 300mm - Ref: L300V
- 400mm - Ref: L400V
- 450mm - Ref: L450V
- 600mm - Ref: L600V

- 300mm - Ref: N300V
- 400mm - Ref: N400V
- 450mm - Ref: N450V
- 600mm - Ref: N600V

- 300mm - Ref: C300V
- 400mm - Ref: C400V
- 450mm - Ref: C450V
- 600mm - Ref: C600V

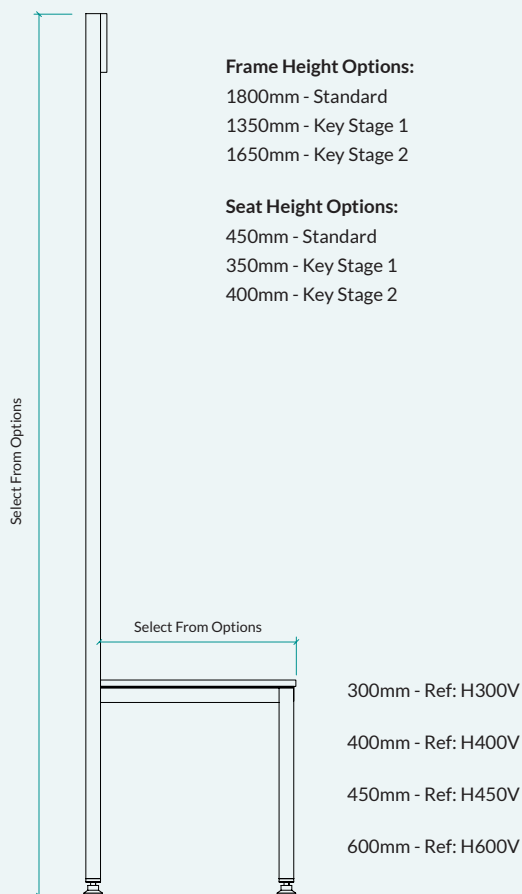

Single Island Bench Frame

- Frame Height Options:**
 1800mm - Standard
 1350mm - Key Stage 1
 1650mm - Key Stage 2
- Seat Height Options:**
 450mm - Standard
 350mm - Key Stage 1
 400mm - Key Stage 2

- 300mm - Ref: H300V
- 400mm - Ref: H400V
- 450mm - Ref: H450V
- 600mm - Ref: H600V

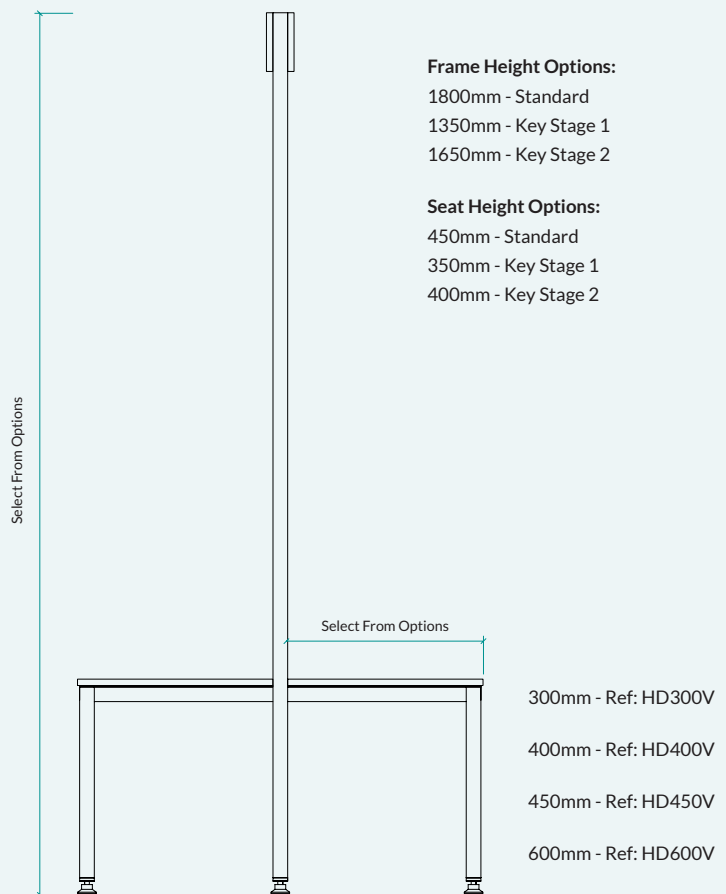

Double Island Bench Frame

- Frame Height Options:**
 1800mm - Standard
 1350mm - Key Stage 1
 1650mm - Key Stage 2
- Seat Height Options:**
 450mm - Standard
 350mm - Key Stage 1
 400mm - Key Stage 2

- 300mm - Ref: HD300V
- 400mm - Ref: HD400V
- 450mm - Ref: HD450V
- 600mm - Ref: HD600V

Hydroline Seat Benching - Typical Details

Frame Sections & Seat Options (based on typical 400mm depth for illustration purposes)

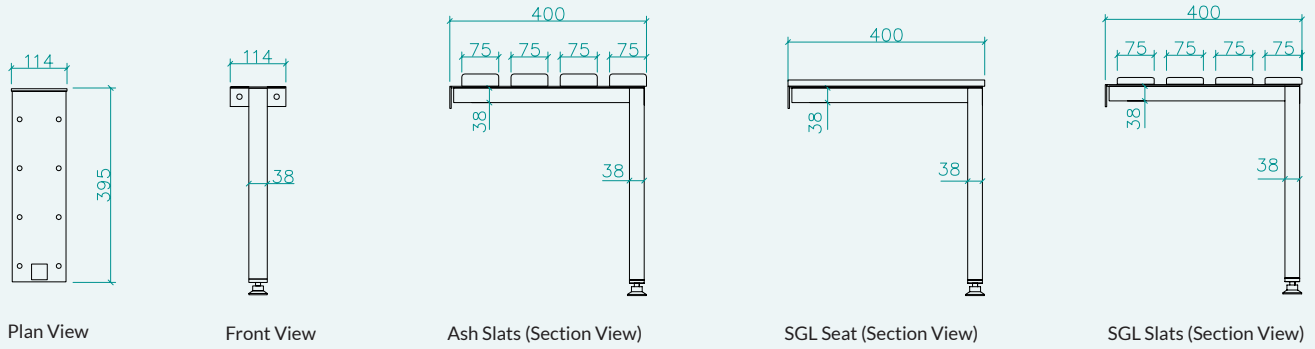

Frame Options

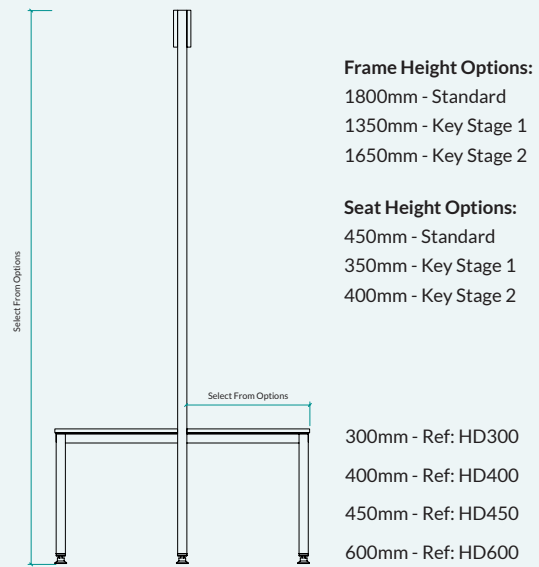
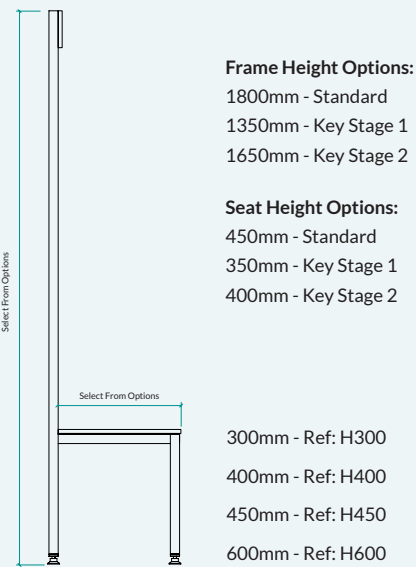
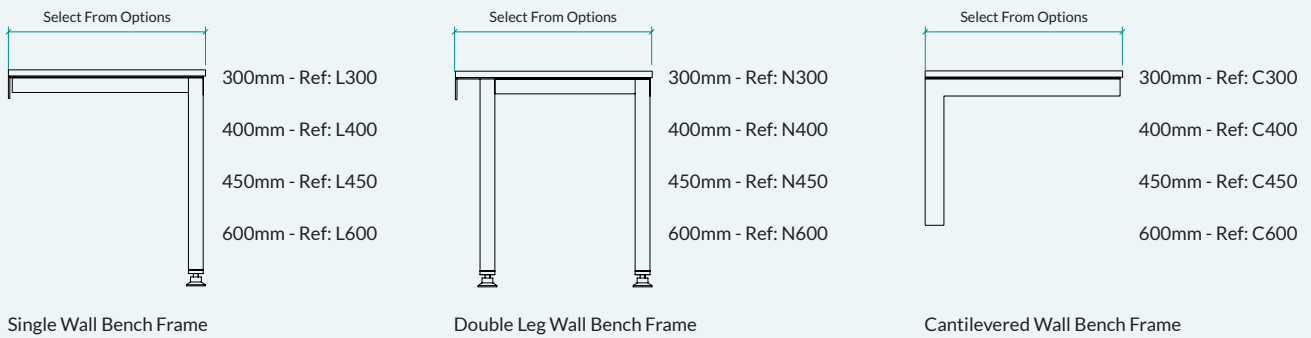

excelsior[®]
washrooms for all environments

Excelsior Panelling Systems Ltd
Unit 2, Woodside Industrial Estate, Pedmore Road, Dudley, West Midlands, DY2 0RL

Tel: +44 (0)1384 267770 Fax: +44 (0)1384 482127
E-mail: enquiries@excelsiorps.co.uk Web: www.excelsior-cubicles.co.uk

