

5 67 262 0

Basis Wiggly snake







made in germany

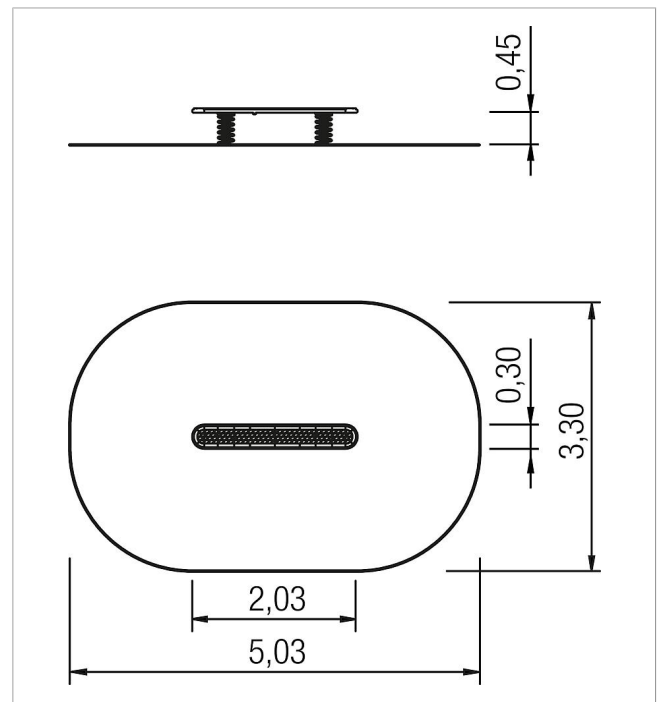

Scope of delivery

1x jiggling skane: stainless steel, high-pressure laminate
2x spring: spring steel



	Material	Steel powder., HPL
	Foundation level	FL 3
	Minimum space	5,03x3,30x2,25 m
	Free falling height	45 cm
	Impact protection net	15,0 m ²
	Foundations	2x CF
	Largest section	203x30x45 cm