

5 67 217 0

## Basis Spring rocker Classic







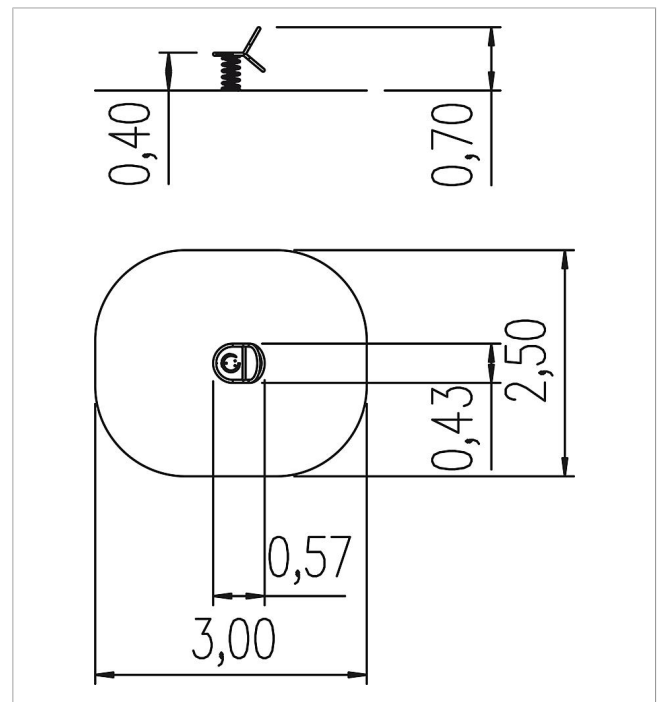

made in germany



### Scope of delivery

1x frame: stainless steel  
1x spring: spring steel



	Material	Stainless steel
	Foundation level	FL 0
	Minimum space	3,00x2,50x2,33 m
	Free falling height	40 cm
	Impact protection net	7,5 m <sup>2</sup>
	Foundations	1x 5632280 + 1x CF
	Assembly	1 person/1 h
	Largest section	57x43x56 cm
	Heaviest section	30 kg