

5 58 407 0

Basis Slide with ladder ph 145 cm







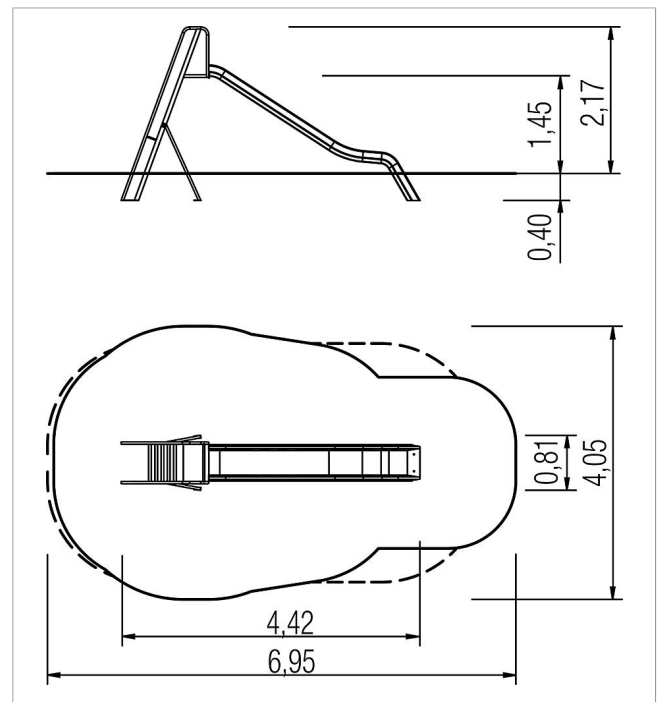

made in germany



Scope of delivery

1x slide PH 145 cm: GFRP
1x slide ascent: galvanised steel



	Material	Steel, GFRP
	Foundation level	FL 1
	Minimum space	6,95x4,05x3,25 m
	Free falling height	145 cm
	Impact protection net	22,0 m ²
	Foundations	5x CF or 5x PFs
	Assembly	2 persons/1 h
	Largest section	313x54x20 cm
	Heaviest section	38 kg