

5 25 133 011 00

unique single swing frame Eagle





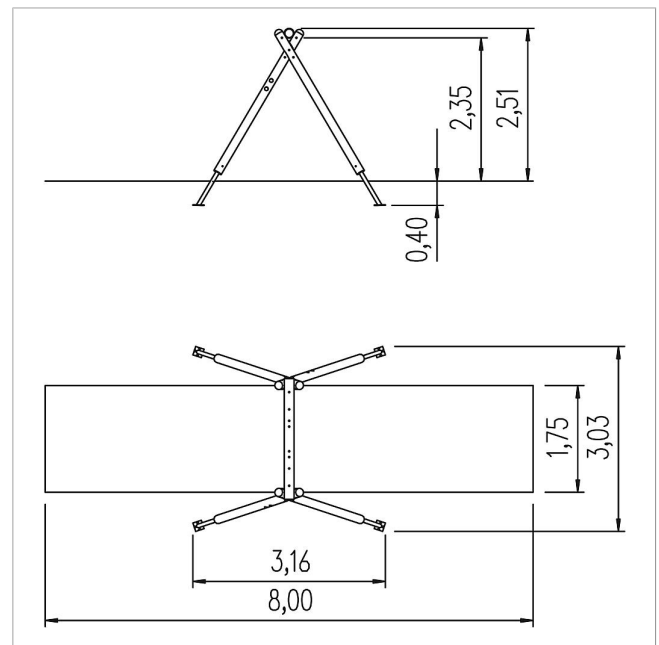

made in germany

3+

Scope of delivery

1x swing frame: SW, galvanised steel
post shoes: galvanised steel



	Material	SW pi
	Foundation level	FL 1
	Minimum space	800x303x317cm
	Free falling height	137 cm
	Impact protection net	14,0 m ²
	Foundations	4x CF or 4x PFs
	Assembly	2 persons/3 h