

5 71 002 511 93

playo single swing Albatros







made in germany

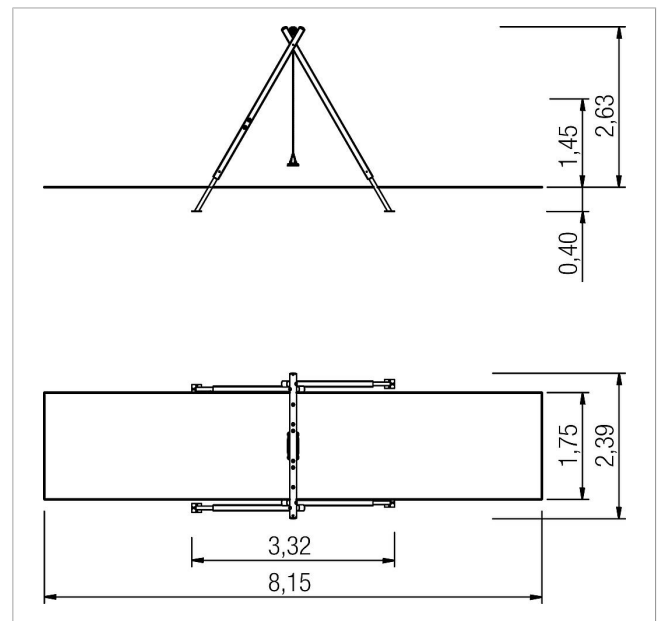

Scope of delivery

- 4x post construction: softwood or steel
- 1x swing beam: softwood or robinia or steel
- 2x bracing: stainless steel (V2A)
- 2x swing joint: stainless steel (V2A)
- 2x deco corner eibe: high-pressure laminate (HPL)
- 2x deco corner: high-pressure laminate (HPL)
- 1x safety swing seat: rubber black, steel
- 2x cover: plastic
- fittings: stainless steel (V2A)



	Material	SW pi, steel galv.
	Foundation level	FL 1
	Minimum space	2,39x8,15x3,25 m
	Free falling height	145 cm
	Impact protection net	14,5 m ²
	Foundations	4x CF
	Largest section	15x15x353 cm