

5 59 060 0

**ecorino sand pit  
Hygipäd**

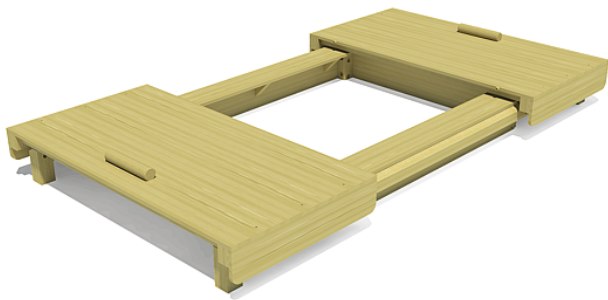





made in germany

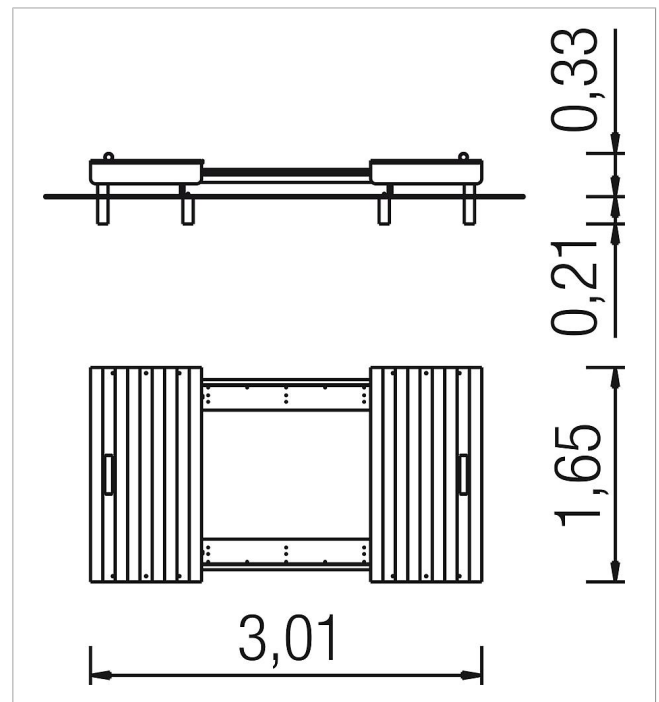

**Scope of delivery**

1x sand pit: SW pi



	Material	SW pi
	Foundation level	-
	Minimum space	3,01x1,65x2,13 m
	Free falling height	33 cm
	Impact protection net	-
	Foundations	-
	Largest section	300x8x6 cm
	Heaviest section	50 kg