

5 25 091 011 00

unique quadruple swing frame Eagle







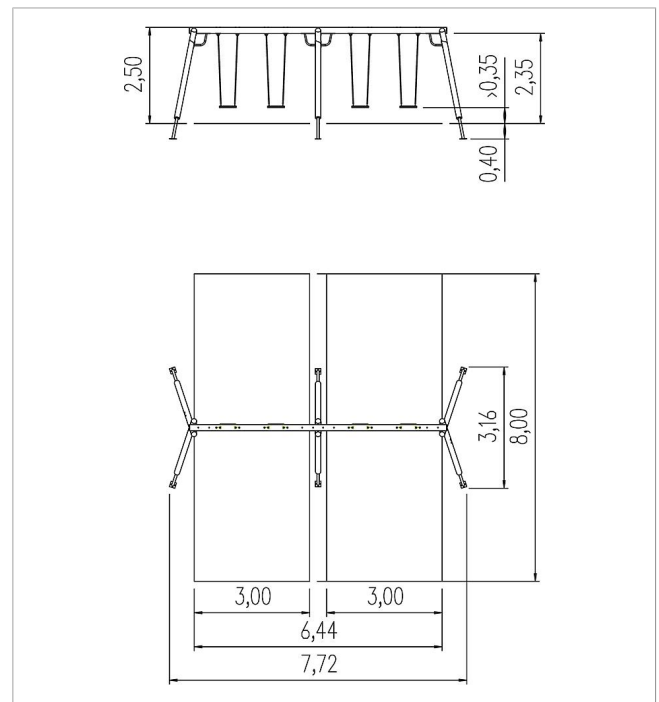

made in germany



Scope of delivery

1x swing frame: SW, galvanised steel
post shoes: galvanised steel



	Material	SW pi
	Foundation level	FL 1
	Minimum space	8,00x7,72x3,80 m
	Free falling height	-
	Impact protection net	50,0 m ²
	Foundations	6x CF or 6x PFs + 6x CF
	Assembly	2 persons/4 h
	Largest section	Ø 16x650 cm
	Heaviest section	60 kg