

5 59 838 011 00

minimondo play unit Coral







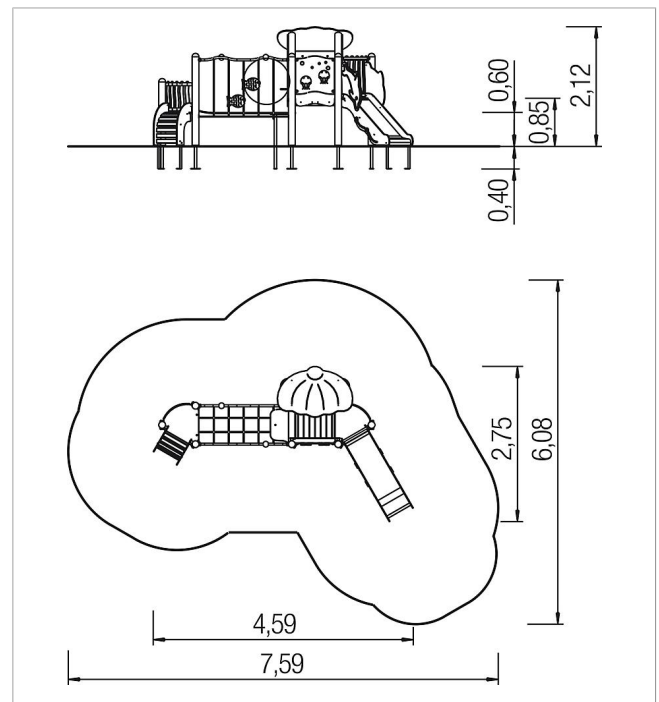

made in germany



Scope of delivery

- 1x panel jellyfish: HPL, PU
- 2x fence element sea grass: stainless steel, HPL
- 1x slide: HPL, stainless steel
- 1x bend ramp: HPL, SW
- 1x net transfer: plastic-coated steel cable, stainless steel, HPL
- 1x roof: HPL
- 1x wall element with window and shutters: HPL, stainless steel
- 1x bench: HPL
- 2x platform surface: HPL, SW
- 1x wood bottom: HPL, SW
- 1x set posts with post bases: SW, galvanised steel



	Material	SW pi
	Foundation level	FL 1
	Minimum space	7,59x6,08x2,65 m
	Free falling height	85 cm
	Impact protection net	31,0 m ²
	Foundations	4x CF or 5x PFs + 6x PFr
	Assembly	2 persons/7 h
	Largest section	2150x490x700 cm
	Heaviest section	80 kg