



5 11 017 011 10

playo play unit Anna, solo







made in germany

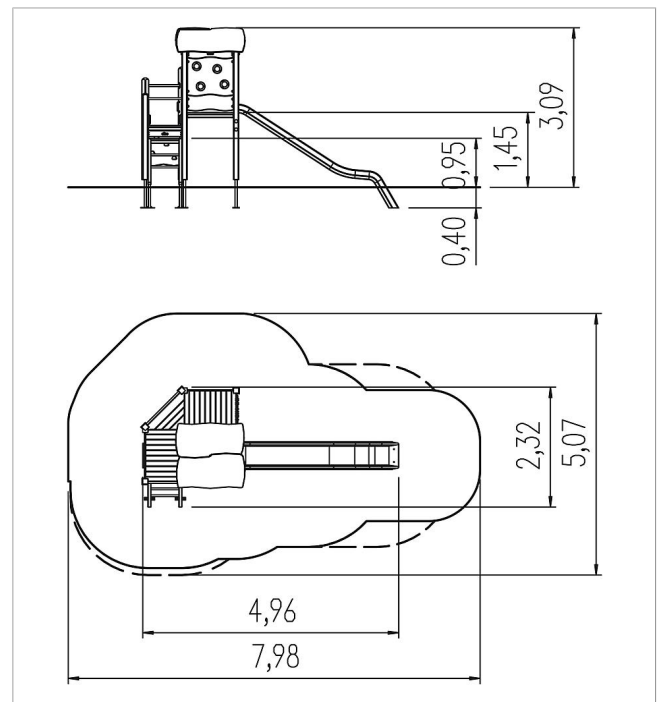

Scope of delivery

- 8x post construction: SW
- 8x post shoe: steel galvanised
- 4x platform construction: SW
- 2x adapter: SW
- 6x wall panel: HPL
- 2x walk-through protection leaf: stainless steel
- 2x set of grips: aluminium, plastic coated
- 1x house roof: HPL
- 1x climbing panel: HPL
- 1x ladder: SW, rungs stainless steel
- 1x slide entry plate: HPL
- 1x play panel hole: HPL, perspex
- 1x play panel wavy grooves: HPL
- 1x play panel dice disc: HPL, steel galvanised
- 1x play panel counting rings: HPL, ROB
- fittings: stainless steel



	Material	SW pi
	Foundation level	FL 1
	Minimum space	7,83x5,07x3,25 m
	Free falling height	145 cm
	Impact protection net	29,0 m ²
	Foundations	9x CF or 9x PFs
	Assembly	2 persons/8 h