

5 56 083 0







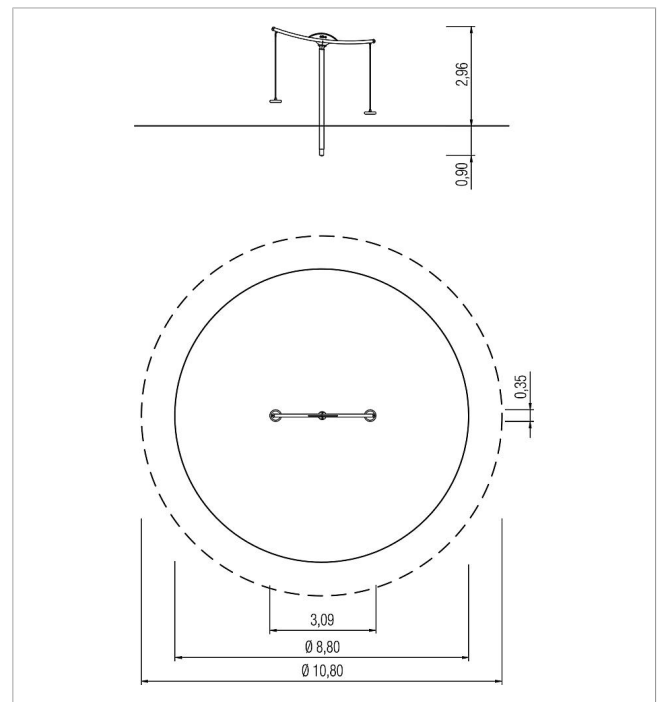

**Basis Pendulum
carousel Hyperion Ø
310**
made in germany



Scope of delivery

- 1x post Ø 13,9 cm: steel hot-dip galvanised
- 1x crossbeams Ø 8,9 cm: steel hot-dip galvanised
- 2x pendulum seat with chain: rubber, stainless steel (VA)



	Material	Steel galv., steel powder., rubber
	Foundation level	FL 3
	Minimum space	Ø 10,80x4,00 m
	Free falling height	105 cm
	Impact protection net	98,5 m ²
	Foundations	1x CF
	Assembly	2 persons/6 h
	Largest section	330x30x30 cm
	Heaviest section	50 kg