

Mini play house Florentin



Age indication



Social skills



Fitness



Balance



Speed



Imagination

Scope of delivery

Play house consisting of:

1x house: stainless steel, high-pressure laminate (HPL), HDPE

1x stairs: stainless steel, high-pressure laminate (HPL), HDPE



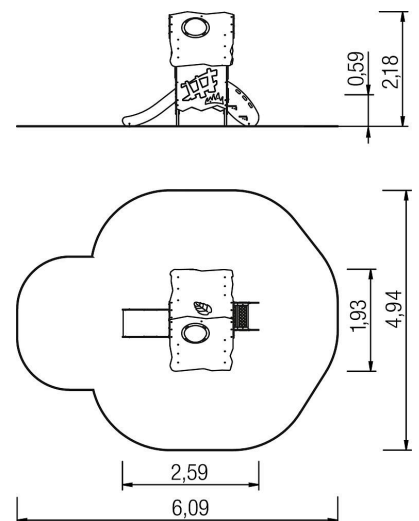





1x slide ph 60 cm: stainless steel, HDPE





Mini play house Florentin



Technical data

	Material	Stainless steel, HDPE, HPL, PE
	Minimum space	6,09x4,94x2,39 m
	Impact protection net	-
	Free falling height	59 cm
	Ground constitution DE/NL/BE	at least concrete
	Ground constitution all except DE/NL/BE	at least concrete
	Size	1,93x2,59x2,18 m
	mx. number of users	7

Installation information

	Foundations	4x CF
	Fundamentlevel	FL 3