

5 59 117 0

playo large train
Tender





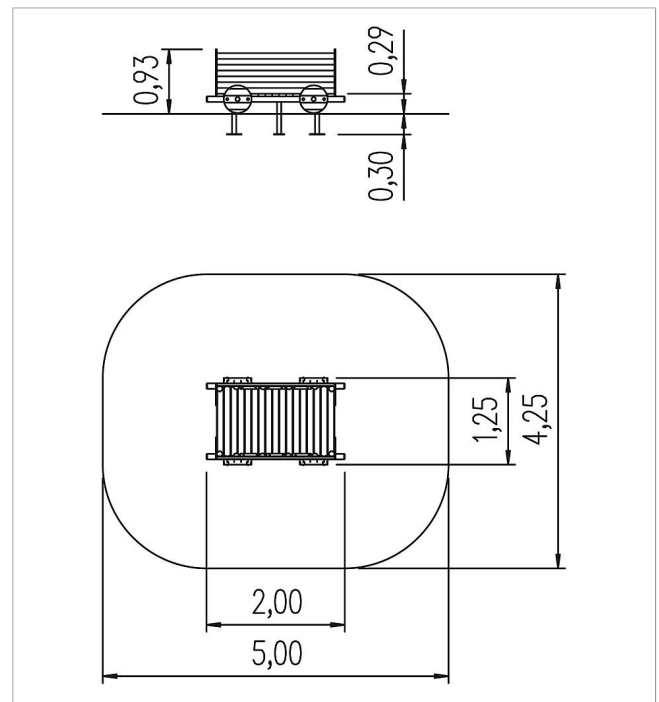

made in germany

3+

Scope of delivery

2x side walls: SW
1x platform bottom: SW
4x wheels: SW
4x side parts: HPL



	Material	SW pi
	Foundation level	-
	Minimum space	5,00x4,25x2,09 m
	Free falling height	29 cm
	Impact protection net	19,5 m ²
	Foundations	-
	Largest section	212x110x50 cm
	Heaviest section	140 kg