

5 55 227 5

unique hexagonal fun climbing unit 210







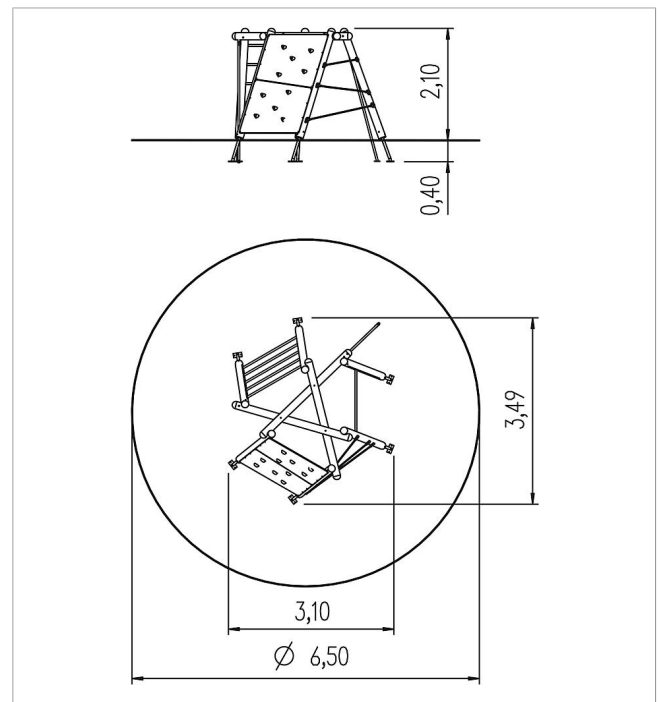

made in germany



Scope of delivery

1x climbing wall: HPL
2x cable constructions: polyester-coated steel cable
1x horizontal bar: stainless steel
1x sliding pole: stainless steel
rung wall: stainless steel
wood construction: SW
post shoes: galvanised steel



	Material	SW pi
	Foundation level	FL 1
	Minimum space	Ø 6,50x3,85 m
	Free falling height	205 cm
	Impact protection net	34,0 m ²
	Foundations	8x CF or 8x PFs
	Assembly	2 persons/4 h
	Largest section	Ø 14x260 cm
	Heaviest section	20 kg