

# Double swing Falcon



Age indication



Speed



Senses



Social skills

## Scope of delivery



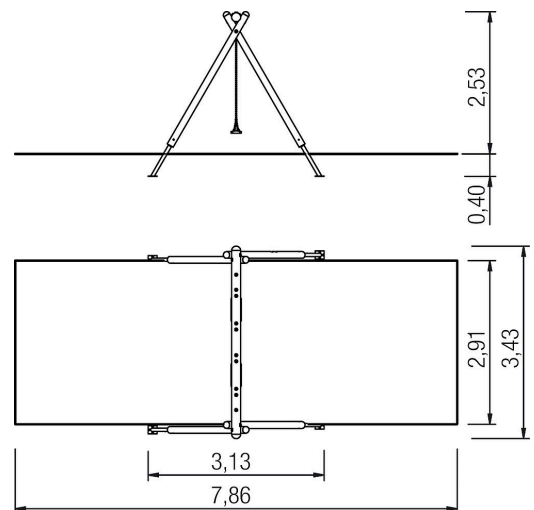



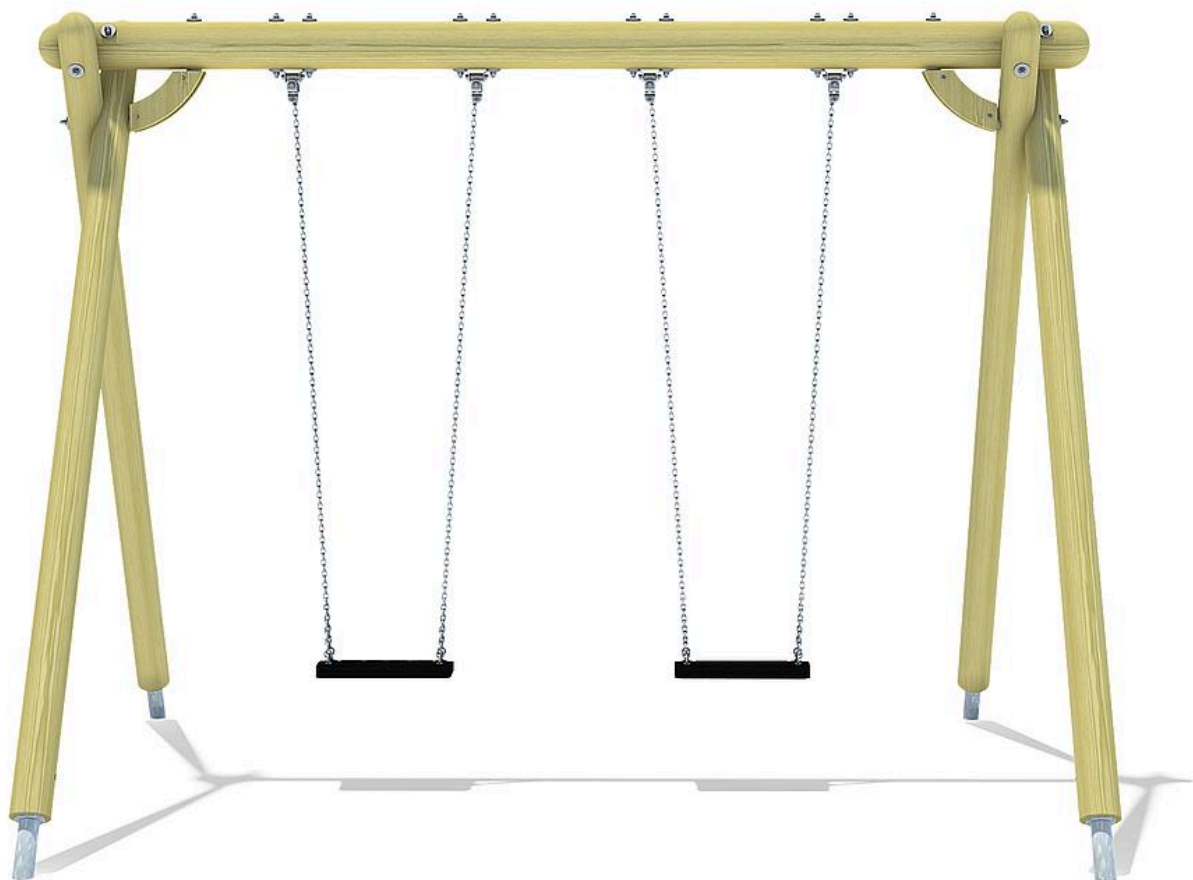



- 4x post construction: softwood
- 1x swing beam: softwood
- 2x bracing: stainless steel (V2A)
- 4x swing joint: stainless steel (V2A)
- 4x deco corner piece: softwood
- 2x safety swing seat with chain: black rubber, stainless steel (V2A)
- fittings: stainless steel (V2A)













# Double swing Falcon



## Technical data

	Material	SW pi
	Minimum space	7,86x3,43x3,18 m
	Impact protection net	23,0 m <sup>2</sup>
	Free falling height	138 cm
	Ground constitution DE/NL/BE	at least lawn
	Ground constitution all except DE/NL/BE	at least sand
	Largest section	Ø 0,15x3,42 m
	mx. number of users	2
	Tested according to standard	EN 1176 - 1/2/7
	Service interval (in months)	3

## Installation information

	Foundations	4x PFs or 4x CF
	Fundamentlevel	ET 400
	PF Accessories	4x 5632540
	PF drainage	-
	PF concrete	-
	PF excavation	0,92 m <sup>3</sup>
	CF Accessories	4x 5631120
	CF drainage	-
	CF concrete	0,19 m <sup>3</sup>
	CF excavation	0,45 m <sup>3</sup>

Legend: PF=prefabricated foundation, CF=concrete foundation, ET=burial depth, GFRP=glass-fibre reinforced plastic, VA=stainless steel, PH=platform height



5 71 212 011 00

# Double swing Falcon

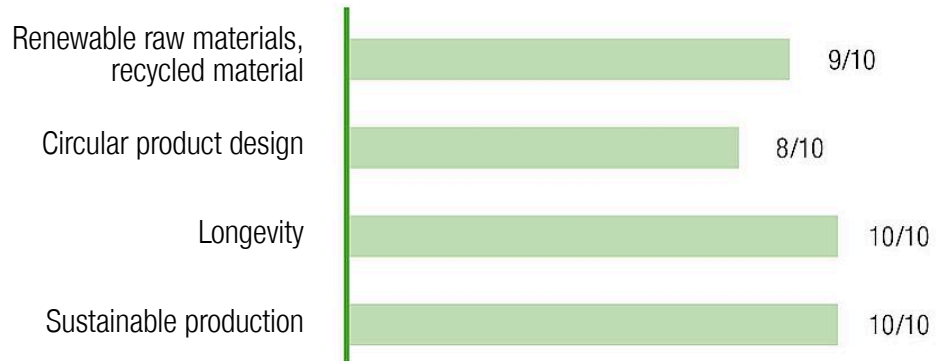

**CO<sub>2</sub> emissions of the product**

**295,9 kg**

**Material share of renewable raw materials**

**76%**

**Recyclate content**

**23%**

Circularity score



Weighted emission factor of the product\*



**Disclaimer:**

This dashboard for the circularity index of the 'Circular Product' certification was generated automatically and is based on the corresponding certification of eibe Produktion + Vertrieb GmbH & Co KG, Industriestraße 1, 97285 Röttingen, which was issued on 16 May 2024 by the Gesellschaft für Klimaschutz München GmbH (GKM GmbH) on the basis of the example product Albion play unit from the eibe unique® product line. eibe Produktion + Vertrieb GmbH & Co KG is liable for the accuracy of the contents. The award criteria of the private-law certification 'Circular Product' of GKM GmbH can be viewed at [gesellschaft-klimaschutz.de/zertifizierung/zirkularitaet/](https://gesellschaft-klimaschutz.de/zertifizierung/zirkularitaet/).

\* The CO<sub>2</sub>e emissions of the materials used in the product are taken into account. The emissions that arise during the production process are allocated to the product on a pro-rata basis.

created on: 14 August 2024