

5 67 017 0

Basis Double spring rocker Bear







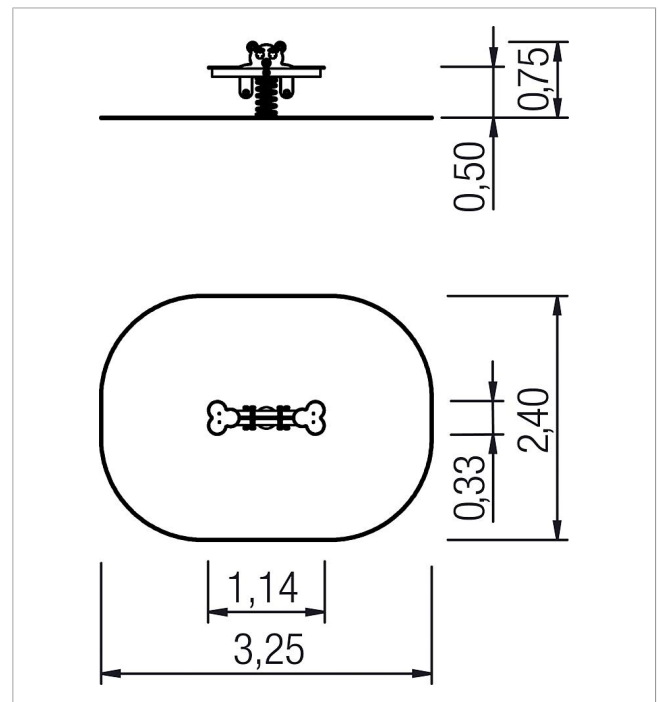

made in germany



Scope of delivery

- 1x spring rocker body: softwood, PE
- 1x flange plate: steel powder
- 1x spring: spring steel



	Material	SW pi, PE
	Foundation level	FL 3
	Minimum space	3,25x2,40x2,30 m
	Free falling height	50 cm
	Impact protection net	7,0 m ²
	Foundations	1x 5632280 + 1x CF
	Assembly	2 persons/1 h
	Largest section	115x55x33 cm
	Heaviest section	7 kg