

5 66 290 0

Basis Crank pump

made in germany

3+

Scope of delivery

1x crank pump: stainless steel

1x self-closing valve

1x connection set

1x particle filter

Technical data:

Output: max 6,0 l/min. (preset at maximum level)

Adjustable to 4 levels:

1st stage: approx. 2.0 l/min

2nd stage: approx. 3.8 l/min

3rd stage: approx. 4.8 l/min







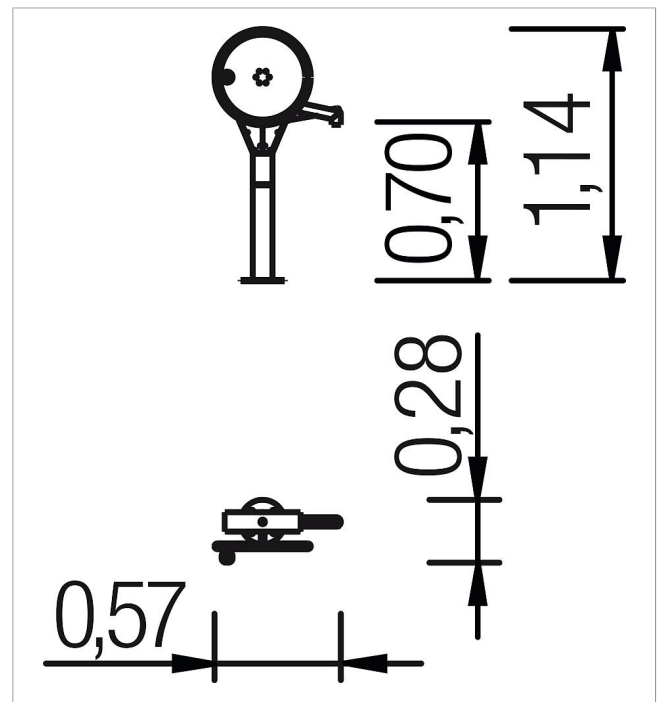

4th stage: approx. 6.0 l/min

Connection to water supply: Geka coupling 1/2".

Hight of pump: 115 cm

Height of outlet: 70 cm



	Material	Stainless steel
	Foundation level	-
	Minimum space	-
	Free falling height	-
	Impact protection net	-
	Foundations	-
	Assembly	1 person/1 h
	Largest section	-
	Heaviest section	-