

5 25 908 011 00

climbo climbing structure Yuki







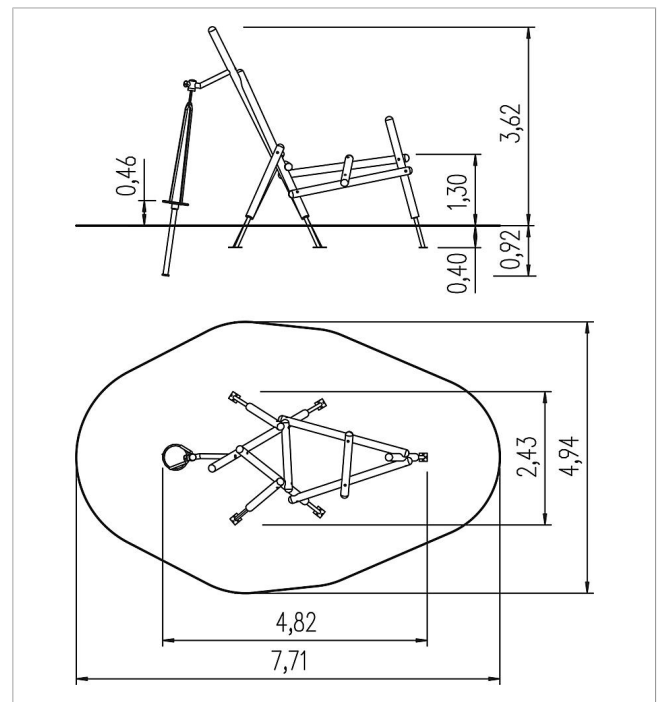

made in germany



Scope of delivery

9x post structure: SW
5x post shoe: galvanised steel
1x double whisk: stainless steel



	Material	SW pi
	Foundation level	FL 1
	Minimum space	7,71x4,94x3,10 m
	Free falling height	130 cm
	Impact protection net	28,5 m ²
	Foundations	6x CF or 5x PFI + 1 CF
	Assembly	2 persons/4 h
	Largest section	Ø 14x468 cm
	Heaviest section	60 kg