

5 25 917 011 00

climbo climbing structure WirrWarrMini

made in germany



Scope of delivery







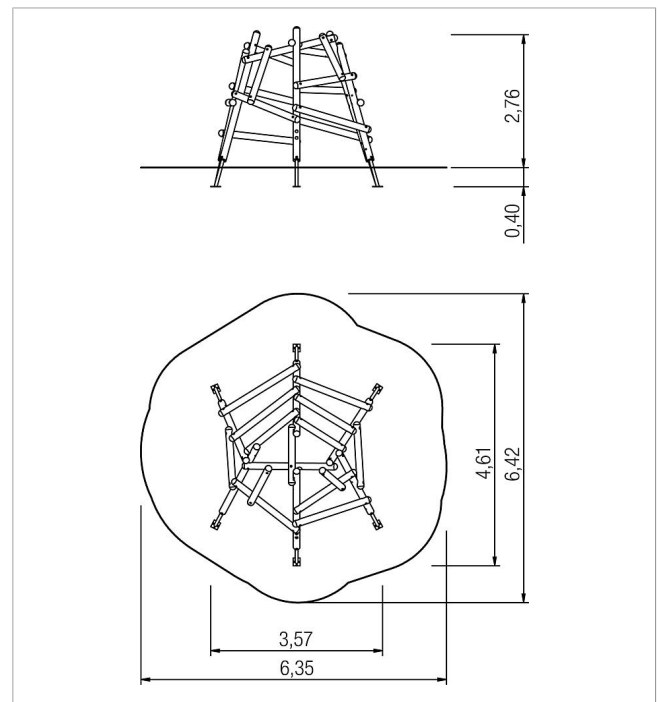

6x post construction: soft wood

15x beam: soft wood

1x net construction: plastic-coated steel cable

fittings: stainless steel (V2A)



	Material	SW pi
	Foundation level	FL 1
	Minimum space	6,35x6,42x2,93 m
	Free falling height	276 cm
	Impact protection net	31,0 m ²
	Foundations	6x CF or 6x PFs
	Largest section	Ø 14x388 cm
	Heaviest section	30 kg