

5 25 900 011 00

climbo climbing structure small Aron







made in germany

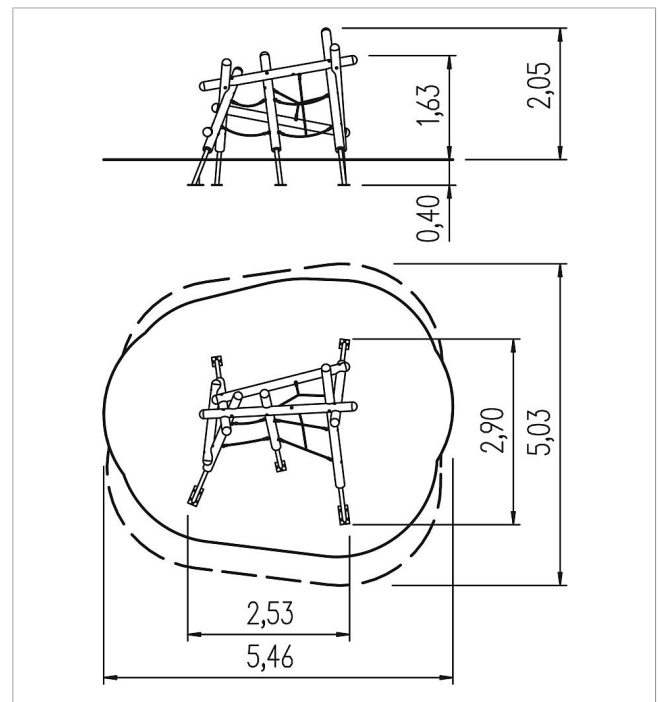

Scope of delivery

- 5x post construction: SW
- 5x post shoe: galvanised steel
- 3x climbing beam: SW
- 4x rope construction: polyester-coated steel cable



	Material	SW pi
	Foundation level	FL 1
	Minimum space	5,64x5,31x2,05 m
	Free falling height	162 cm
	Impact protection net	20,0 m ²
	Foundations	5x CF or 5x PFs
	Assembly	2 persons/2.5 h