

5 25 914 011 00

climbo climbing structure Riku







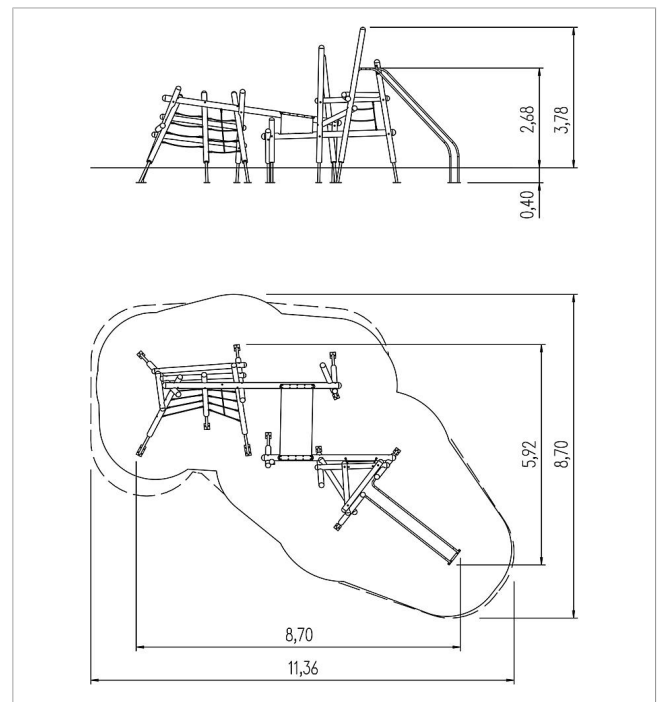

made in germany



Scope of delivery

- 21x post structure: SW
- 12x post shoe: galvanised steel
- 2x net ascent sloped: plastic-coated steel cable, stainless steel
- 1x rope ascent sloped: plastic-coated steel cable, stainless steel
- 1x hammock: belt strap, stainless steel
- 1x hand rail slide: stainless steel



	Material	SW pi
	Foundation level	FL 1
	Minimum space	11,18x9,01x3,78 m
	Free falling height	268 cm
	Impact protection net	57,5 m ²
	Foundations	13x CF or 10x PFI + 1x PFs
	Assembly	2 persons/9 h
	Largest section	Ø 16x485 cm
	Heaviest section	70 kg