

5 55 021 031 00

unique climbing frame 210







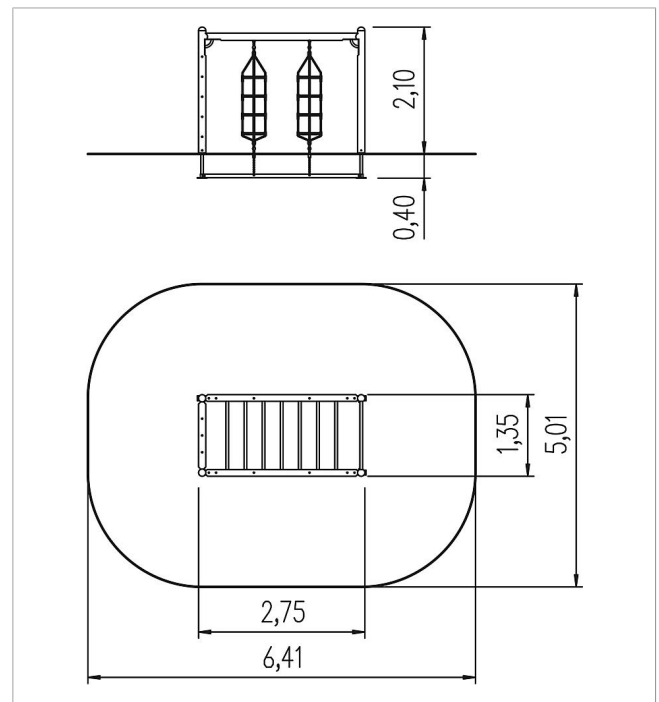

made in germany



Scope of delivery

2x rung elements: SW, ash
 1x climbing net: polyester-coated steel cable
 2x climbing ropes: polyester-coated steel cable
 2x swing ladders: polyester-coated steel cable, polyethylene
 wood construction H 200 cm: SW
 post shoes: galvanised steel



	Material	Larch natural
	Foundation level	FL 1
	Minimum space	6,41x5,01x3,80 m
	Free falling height	200 cm
	Impact protection net	29,5 m ²
	Foundations	4x CF or 4x PFs
	Assembly	2 persons/3 h
	Largest section	250x139x14 cm
	Heaviest section	120 kg