

5 25 912 011 00

**climbo climbing
combination Naomi,
solo**







made in germany

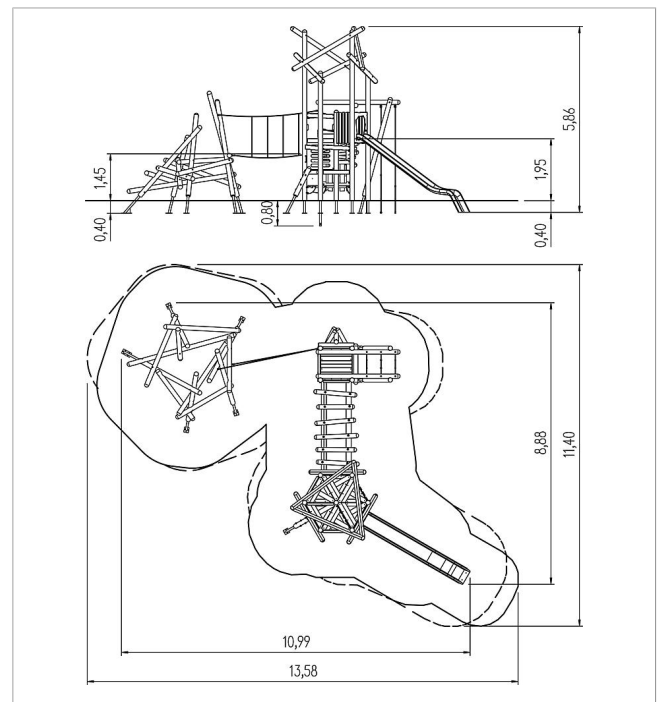

Scope of delivery

- 11x post structure: SW or steel
- 7x platform with planks: SW
- 1x roof crown: SW
- 1x climbing board: HPL
- 1x trunk ascent: SW
- 1x liana ascent: plastic-coated steel cable, SW
- 1x log with crossbars ascent: SW
- 1x log bridge: SW
- 1x climbing structure: SW
- 7x parapet: SW
- 2x walk-through protection: plastic-coated steel cable, stainless steel
- 1x slide entry plate: HPL
- 2x access restriction: HPL
- 3x set of grips: steel
- 2x seat bench: SW, HPL



	Material	SW pi
	Foundation level	FL 1
	Minimum space	13,03x11,29x5,39 m
	Free falling height	195 cm
	Impact protection net	76,0 m ²
	Foundations	21x CF or 6x PFI + 11x PFs + 2x CF
	Assembly	2 persons/14 h