

5 59 045 5

## ecorino block house with porch







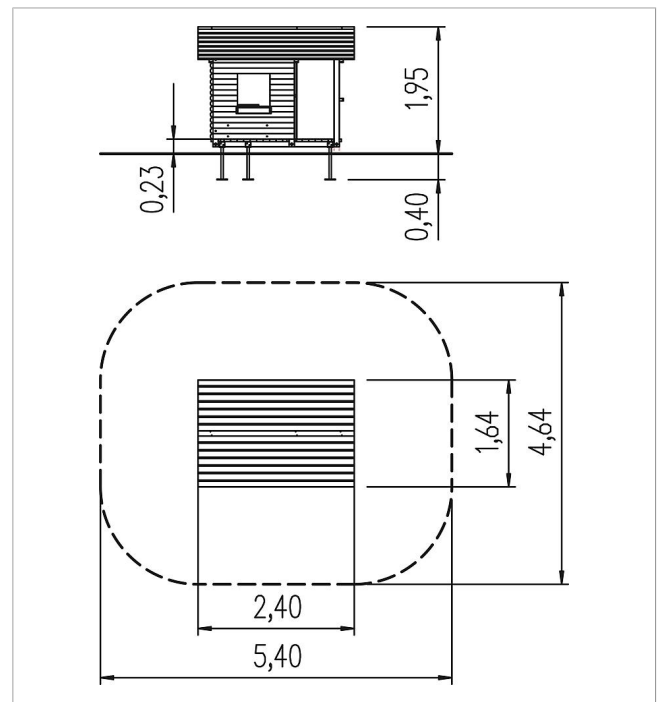

made in germany



### Scope of delivery

set of posts with post shoes: SW pi, galvanised steel  
 set of flower boxes: SW pi  
 table top: SW pi  
 set of seats: SW pi  
 block house: SW pi



	Material	SW pi
	Foundation level	FL 1
	Minimum space	5,40x4,64x1,95 m
	Free falling height	23 cm
	Impact protection net	-
	Foundations	6x CF or 4x PFs
	Assembly	2 persons/2 h
	Largest section	240x100x12 cm
	Heaviest section	30 kg