

5 10 022 011 00

## playo balancing station Terraonda







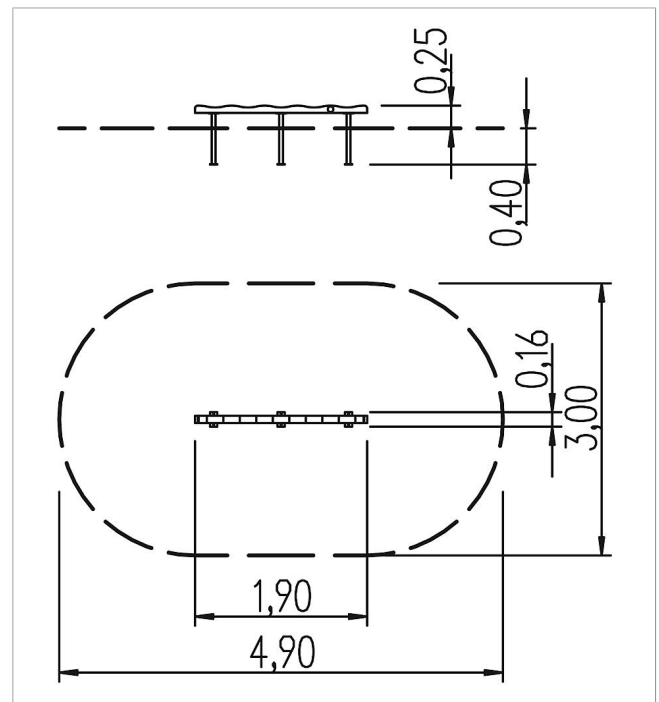

made in germany



### Scope of delivery

1x wavy balancing beam: SW  
set of post shoes: galvanised steel



	Material	SW pi
	Foundation level	FL 1
	Minimum space	4,90x3,00x2,05 m
	Free falling height	25 cm
	Impact protection net	-
	Foundations	3x CF or 3x PFs
	Assembly	1 person/1.5 h
	Largest section	190x8x8 cm
	Heaviest section	20 kg