

5 10 024 011 00

playo balancing station Terracupolino







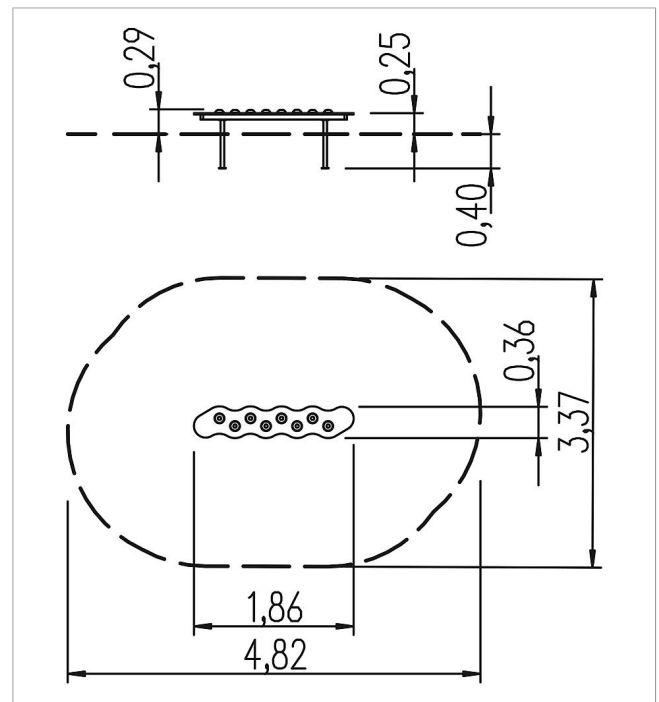

made in germany



Scope of delivery

1x balancing beam with obstacles: SW, HPL, stainless steel
set of post shoes: galvanised steel



	Material	SW pi
	Foundation level	FL 1
	Minimum space	4,82x3,37x2,09 m
	Free falling height	29 cm
	Impact protection net	-
	Foundations	2x CF or 2x PFs
	Assembly	1 person/1.5 h
	Largest section	186x36x2 cm
	Heaviest section	20 kg