

5 25 916 011 00

climbo balancing element x step double







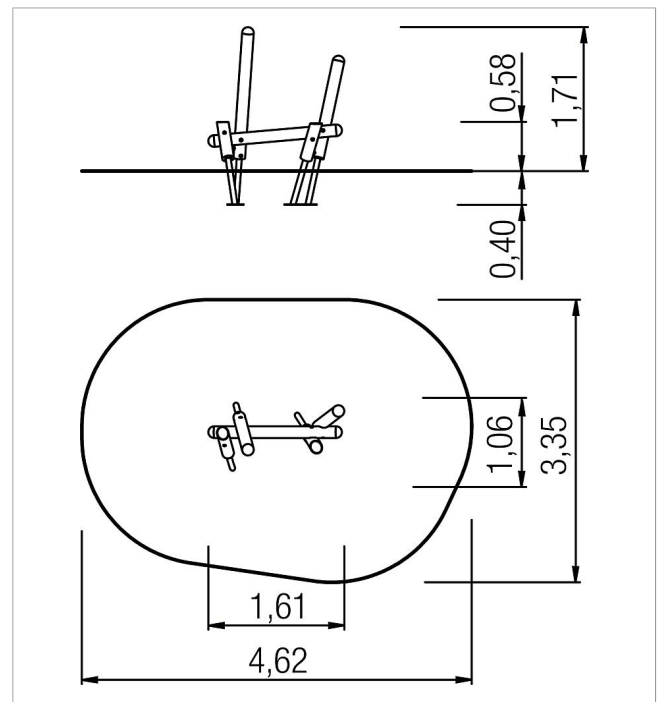

made in germany



Scope of delivery

5x post construction: soft wood
fittings: stainless steel (V2A)



	Material	SW pi
	Foundation level	FL 1
	Minimum space	4,62x3,35x2,39 m
	Free falling height	58 cm
	Impact protection net	13,0 m ²
	Foundations	4x CF or 4x PFs
	Largest section	Ø 14x160 cm
	Heaviest section	7,86 kg