



5 45 084 063 00

paradiso balancing combination Rochwin







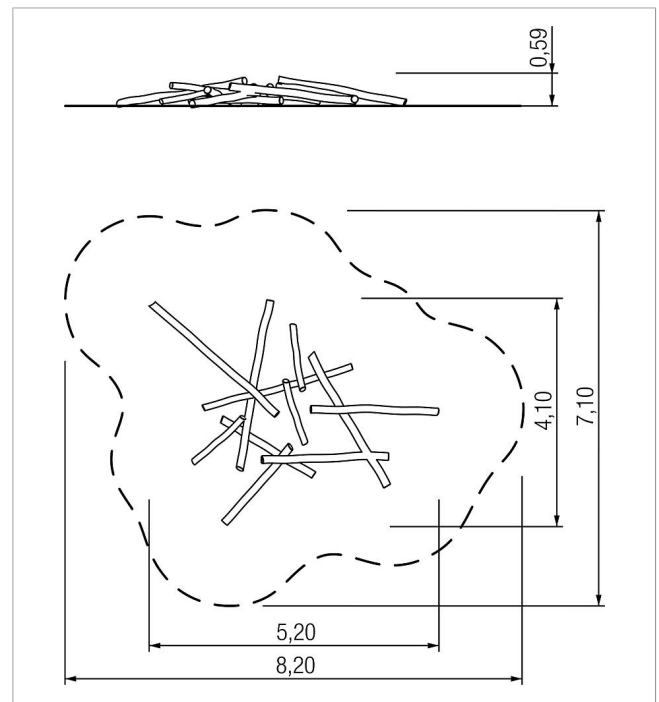

made in germany



Scope of delivery

11x balancing beam: robinia
11x ground angle: steel hot-dip galvanised



	Material	Robinia natural
	Foundation level	-
	Minimum space	8,20x7,20x2,39 m
	Free falling height	60 cm
	Impact protection net	41,0 m ²
	Foundations	11x CF or 11x PFs
	Assembly	2 persons/7 h
	Largest section	Ø 10-14x310 cm