

5 55 304 5

balance Quick Step Criss-Cross







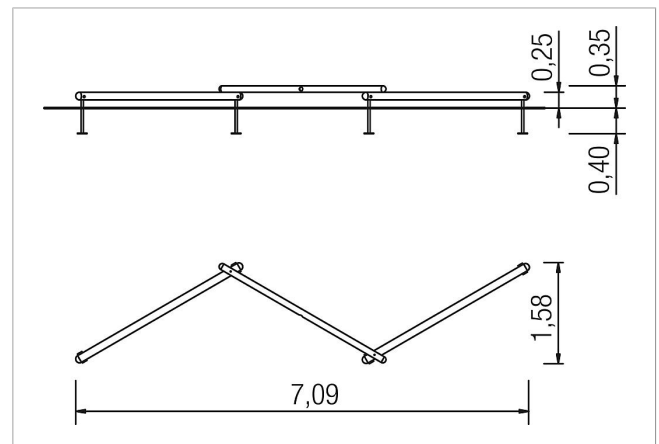

made in germany



Scope of delivery

1x Quick Step: SW
4x post shoe: galvanised steel



	Material	SW pi
	Foundation level	FL 1
	Minimum space	9,76x5,56x2,15 m
	Free falling height	35 cm
	Impact protection net	-
	Foundations	4x CF or 4x PFs
	Assembly	1 person/2 h
	Largest section	300xØ 12 cm
	Heaviest section	24 kg