

5 55 327 5

balance Paso Doble professional







made in germany

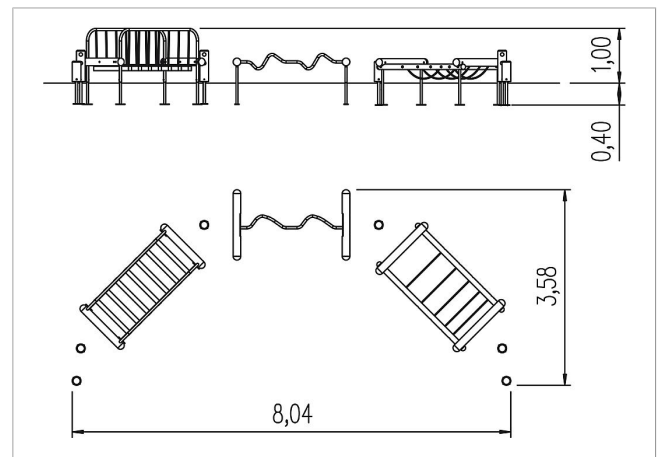

Scope of delivery

1x 5553245 Boogy Woogy: SW
 1x 5553135 Cha Cha Cha: SW
 1x 5553165 Samba: SW
 3x 5553105 Step 40: SW
 3x 5553115 Step 60: SW
 post shoes: galvanised steel, painted plate



| | | |
|-------------------------------------------------------------------------------------|-----------------------|---------------------------|
|  | Material | SW pi |
|  | Foundation level | FL 1 |
|  | Minimum space | 8,06x3,59x2,39 m |
|  | Free falling height | 54 cm |
|  | Impact protection net | - |
|  | Foundations | 18x CF or 12x PFs + 6x CF |
|  | Largest section | 242x116xØ 42 cm |
|  | Heaviest section | 60 kg |