

5 54 043 0

fit active-station shoulder wheel







made in germany

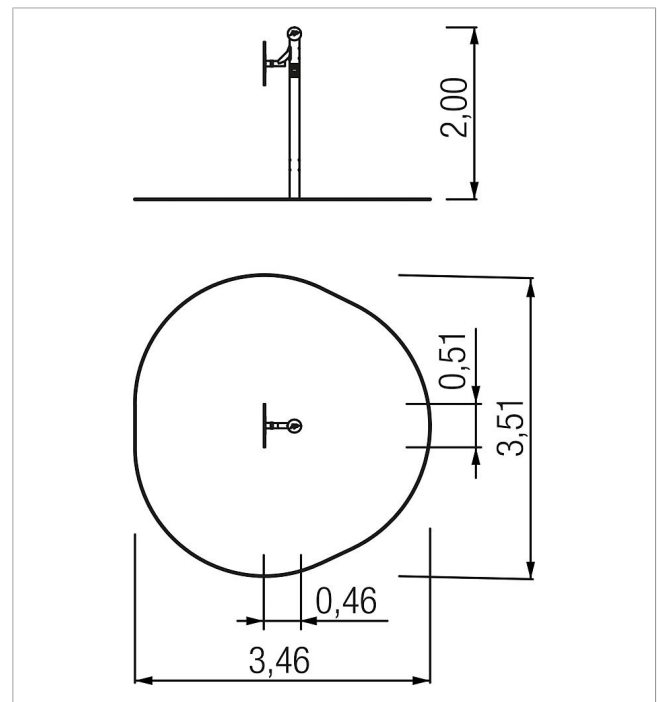

Scope of delivery

1x active-station: stainless steel, HDPE



	Material	Stainless steel, HDPE
	Foundation level	FL 2
	Minimum space	3,46x3,51x3,80 m
	Free falling height	-
	Impact protection net	1,0 m ²
	Foundations	1x CF