

## Sombra Ds

600x600, 1200x600,  
625x625, 1250x625,  
24"x24", 24"x48"

**M227**

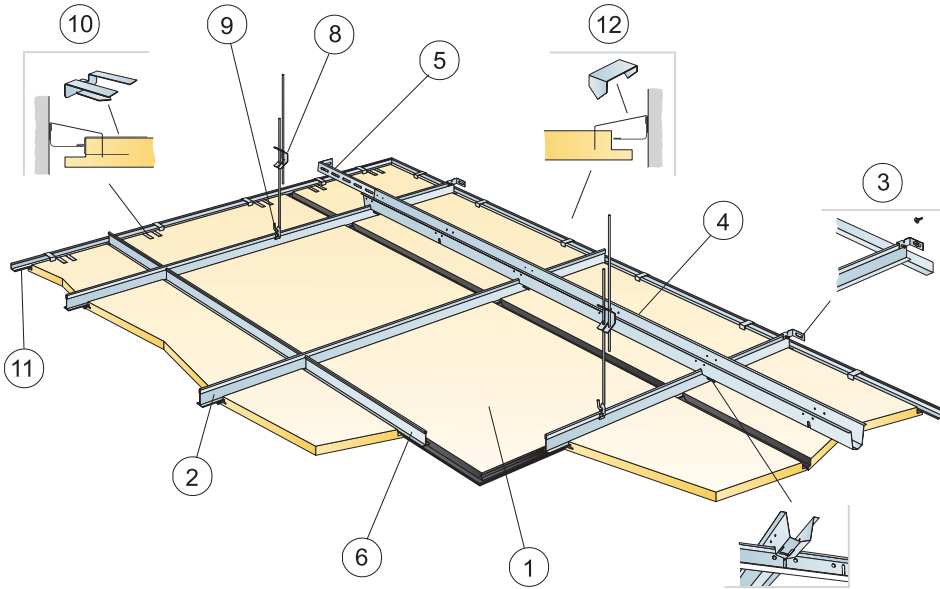
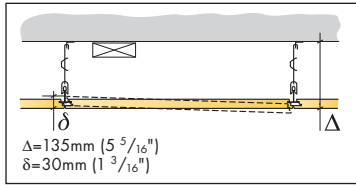

1. Connect T-24 Main runner HD

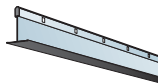

2. Connect Wall bracket

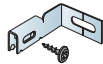

3. Connect Space bar

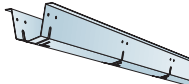

4. Connect Wall bracket

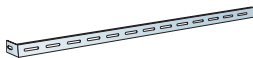

5. Connect T-24 Cross tee,  
L=600/625/24"

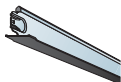

6. Connect Space bar winch



7. Connect Adjustable hanger



8. Connect Hanger clip



9. Connect Support clip Dg20



10. Connect Angle trim 22/22, fixed at 300  
mm centres



11. Connect Perimeter tile clip



**Ecophon**<sup>®</sup>  
SAINT-GOBAIN

---

A SOUND EFFECT ON PEOPLE

[www.ecophon.com](http://www.ecophon.com)

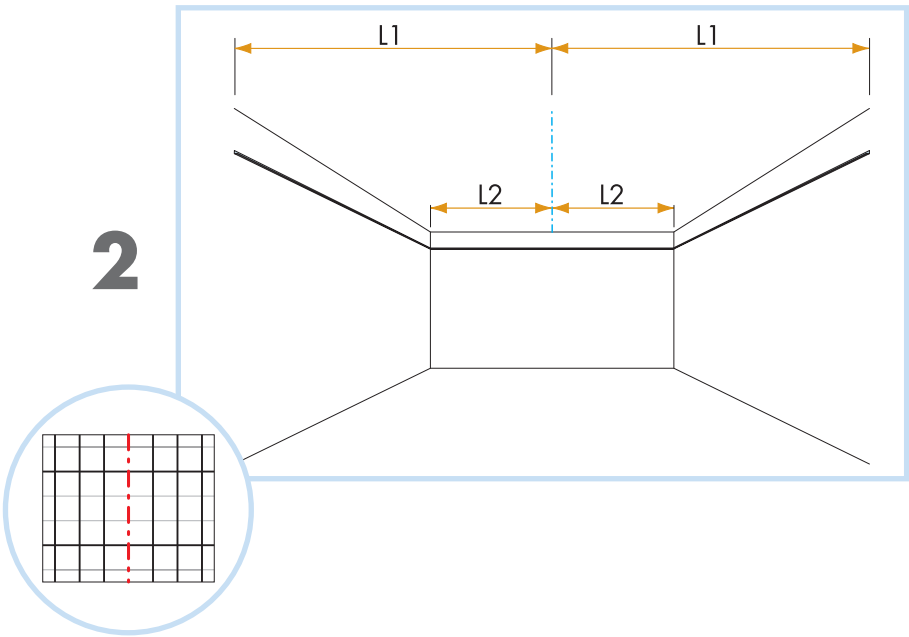
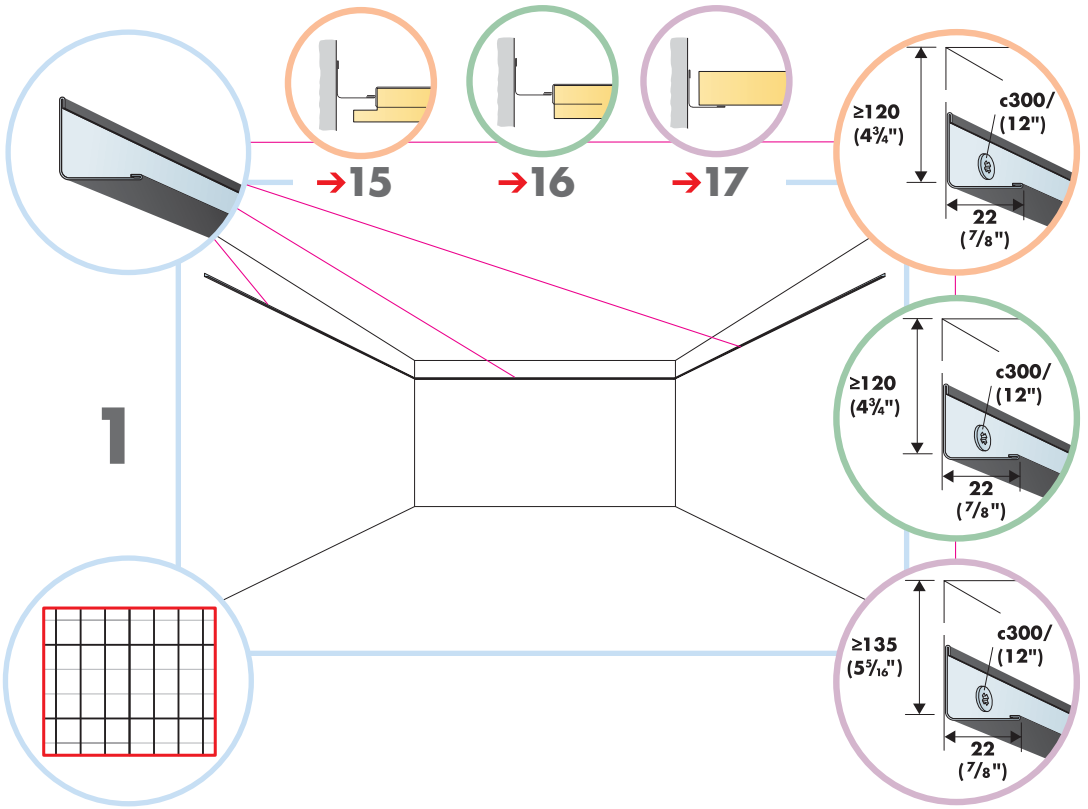

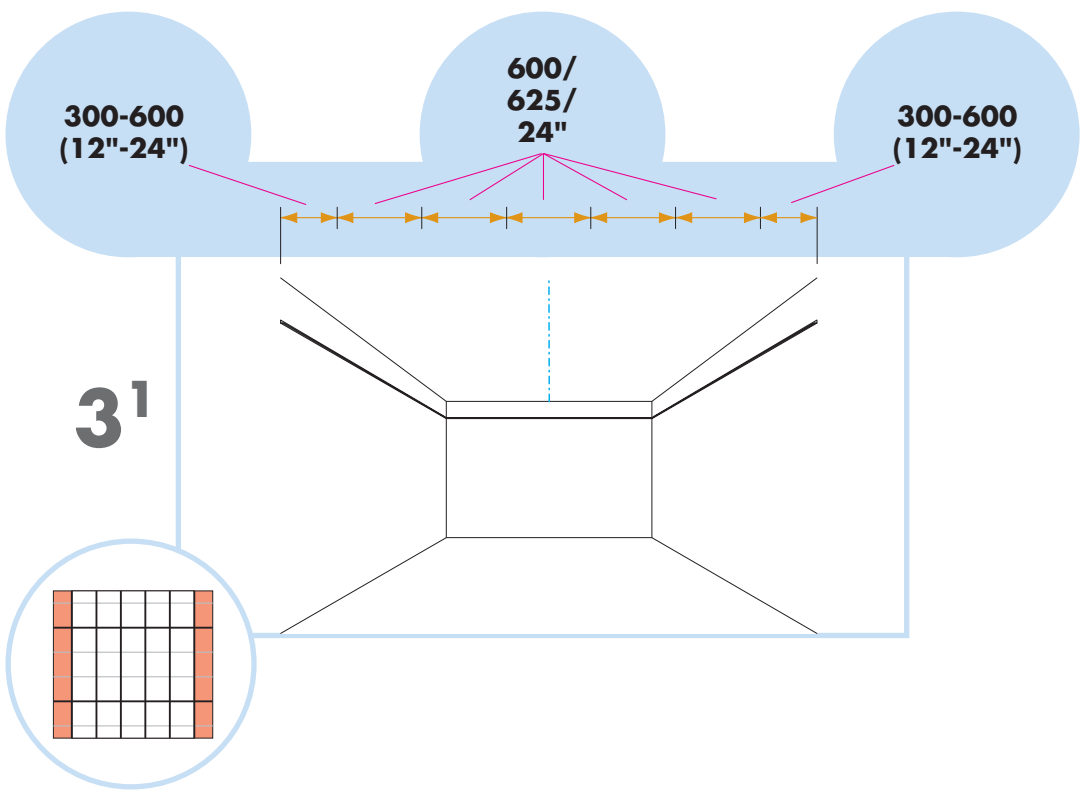
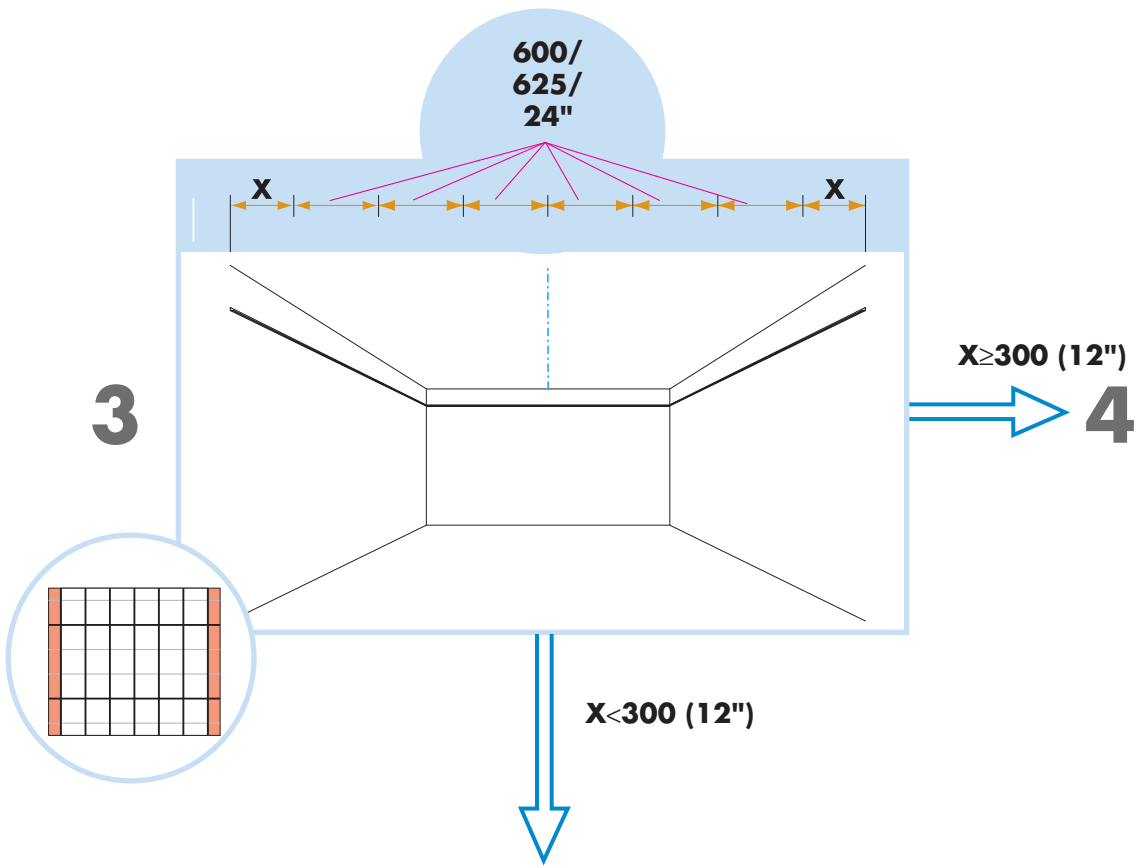

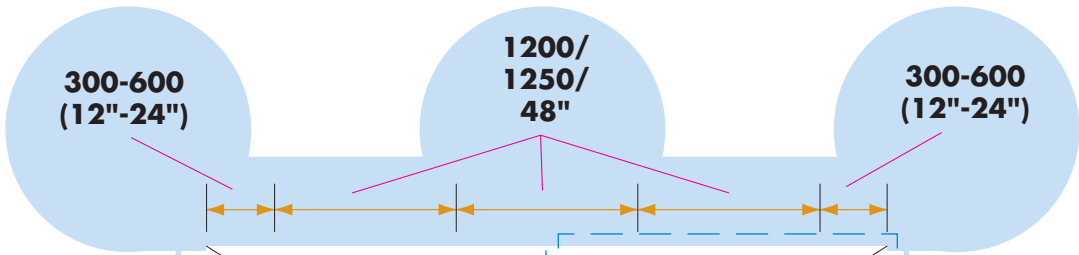

4

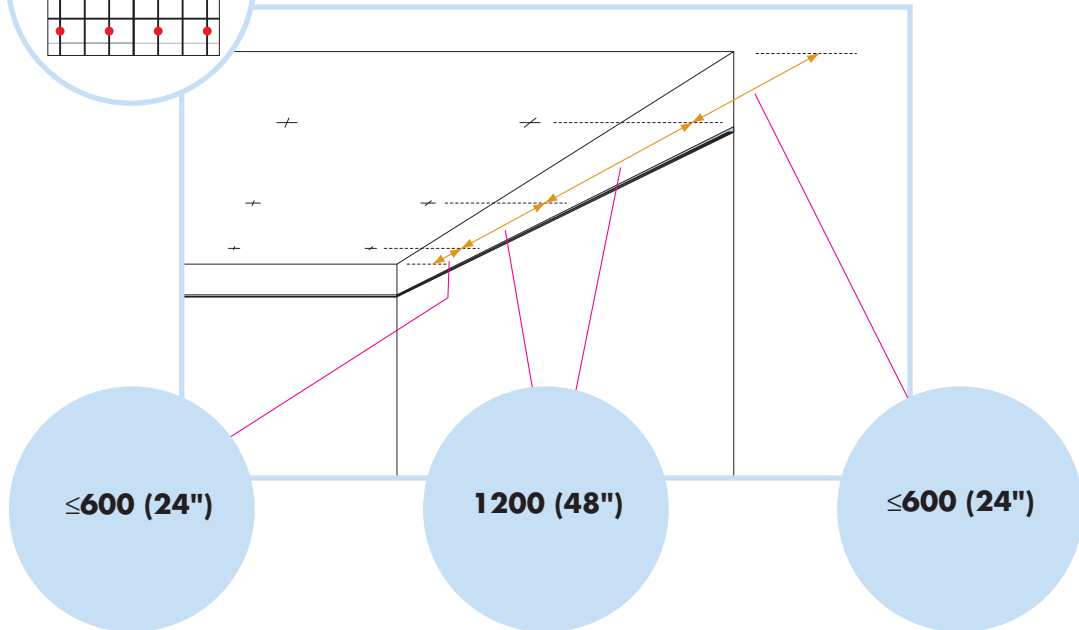
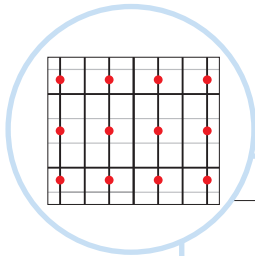
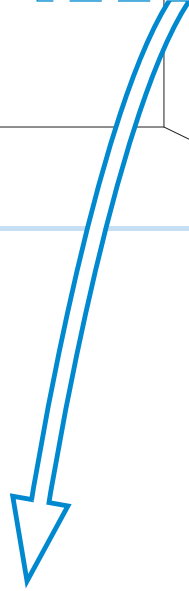
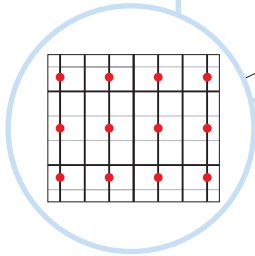

# 5

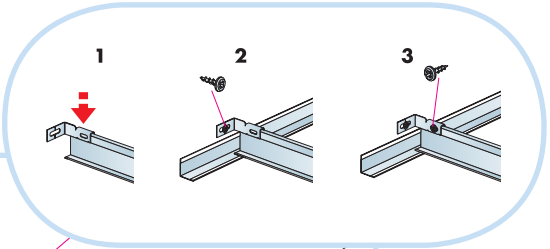
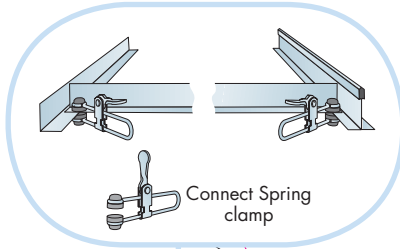
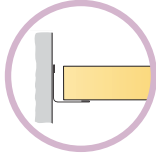
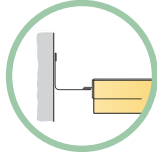
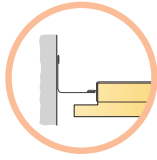
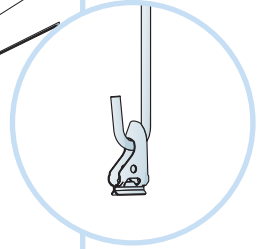
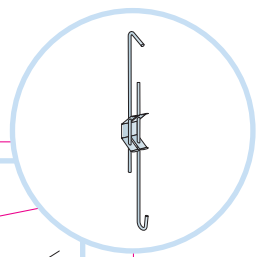
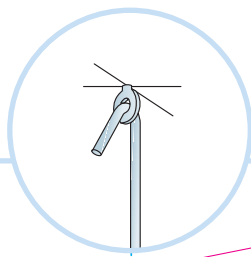
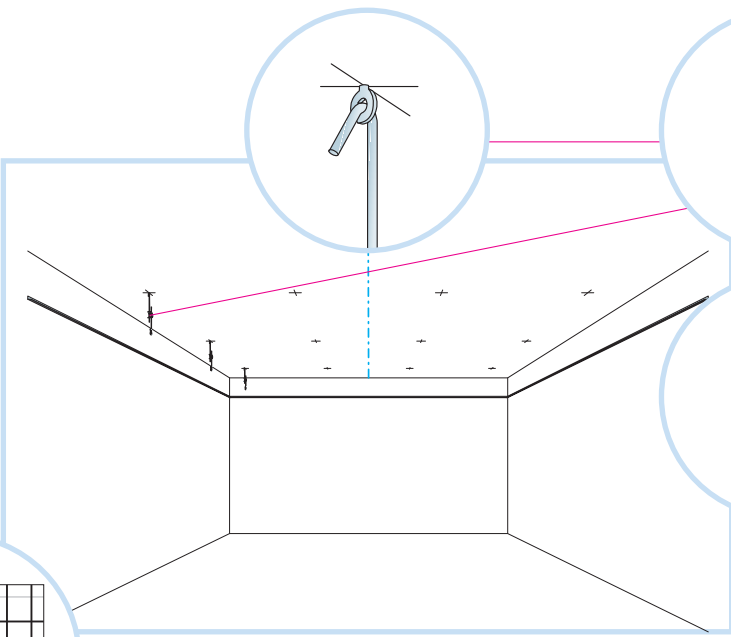
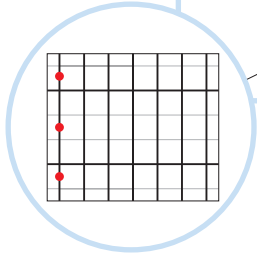

# 6

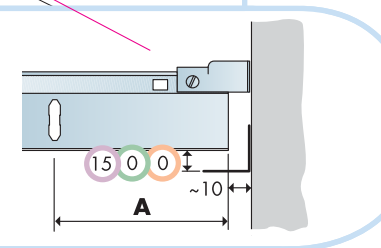
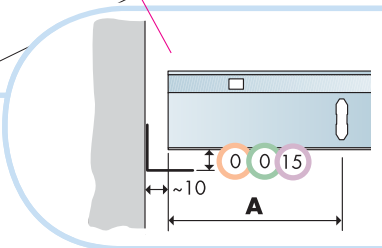
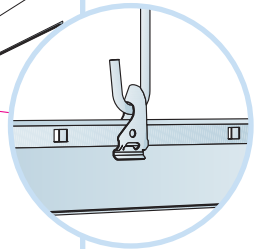
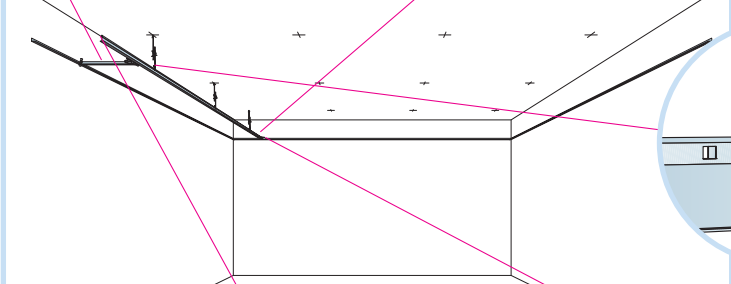
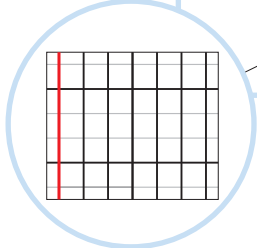

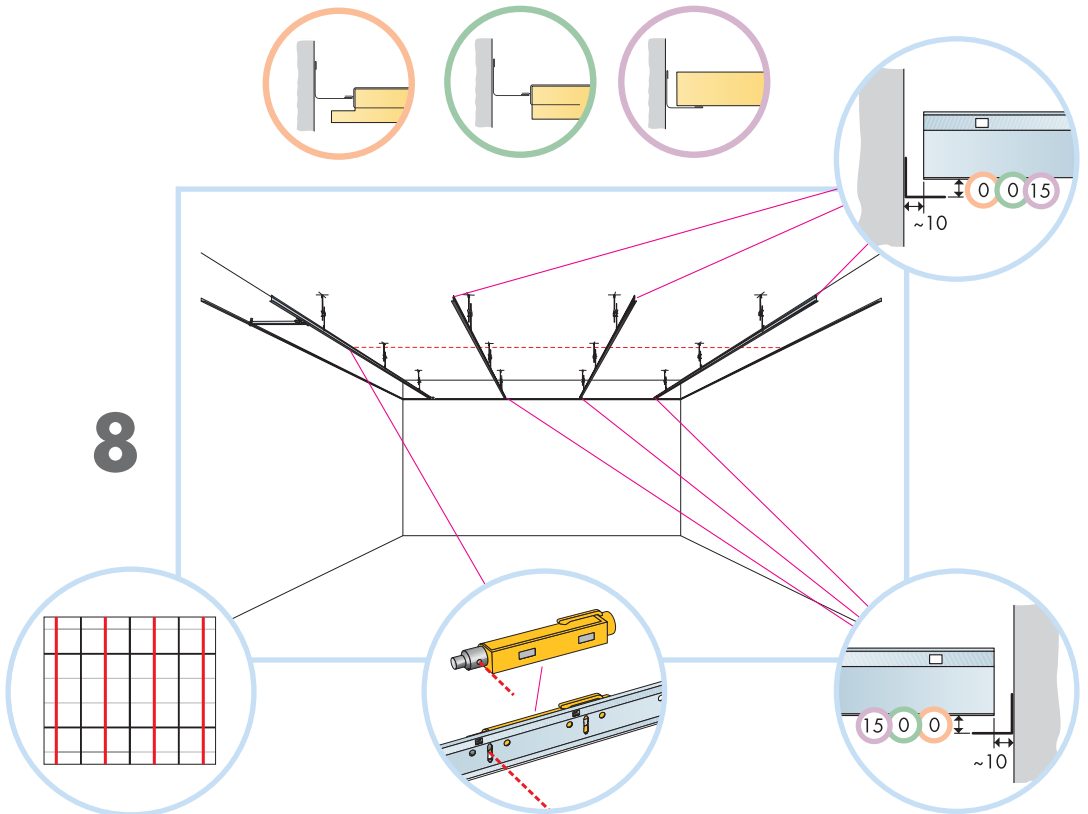
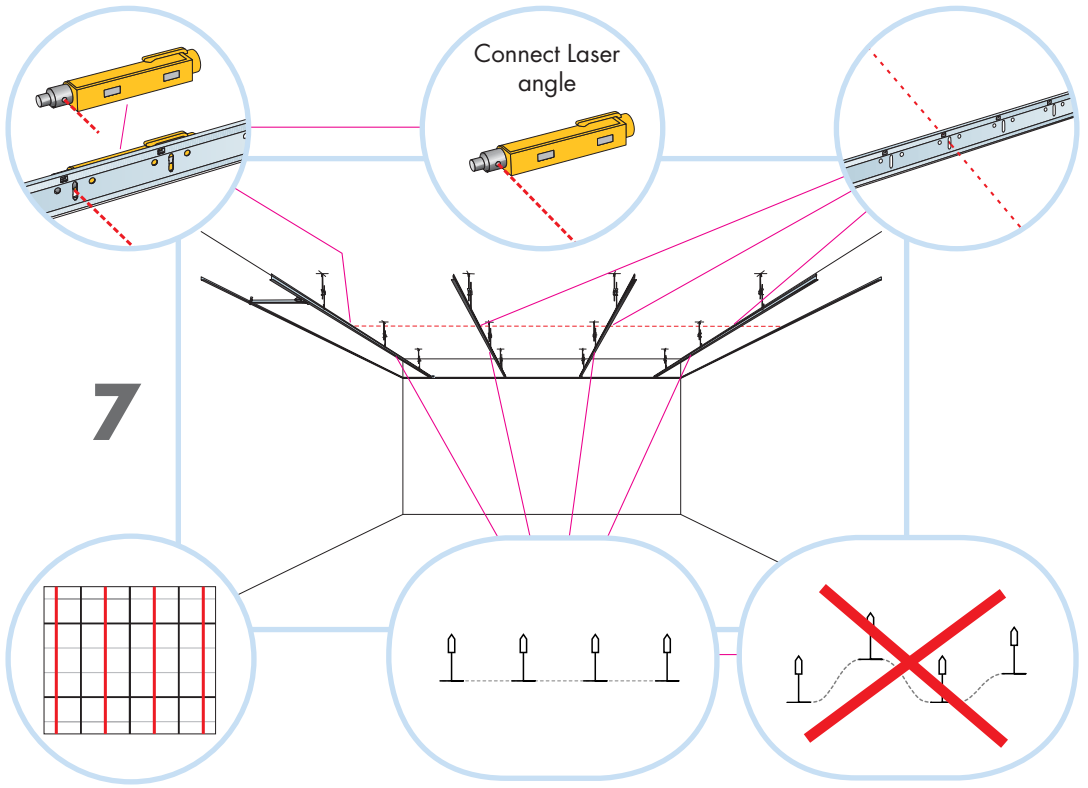

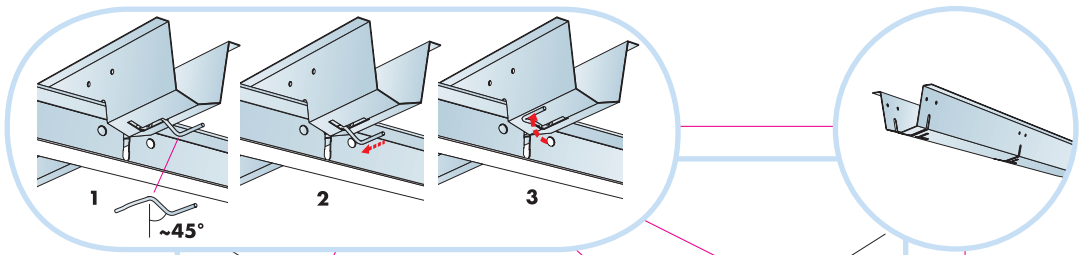

9

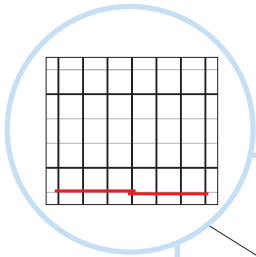
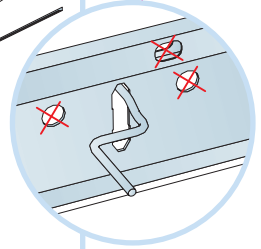
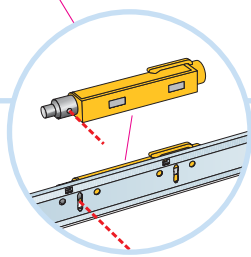
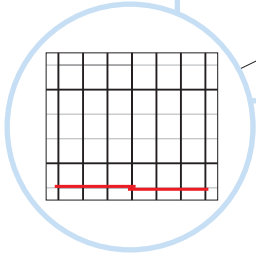

10

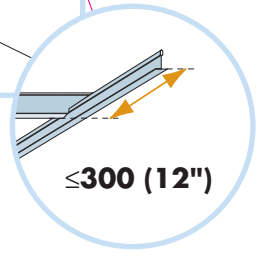
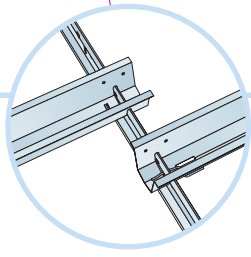
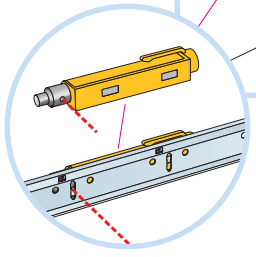

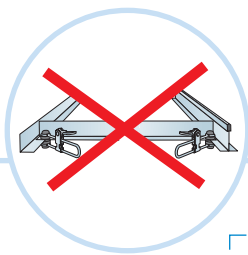
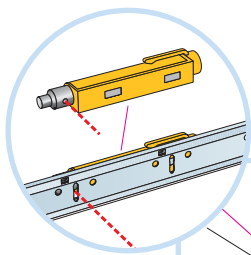

11

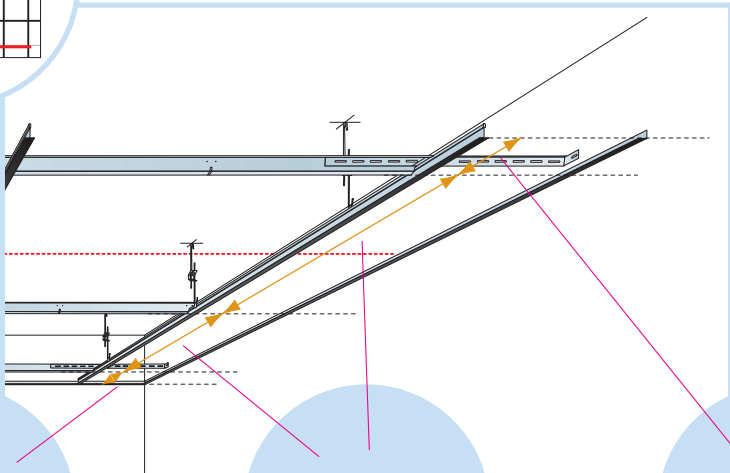
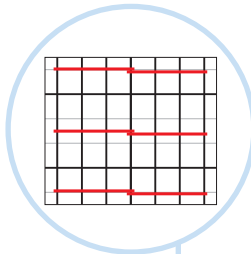
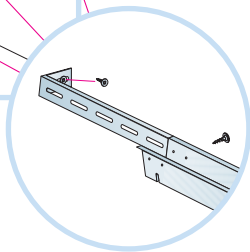
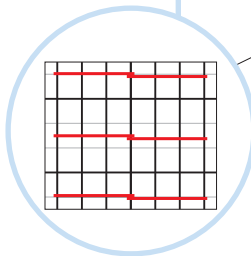
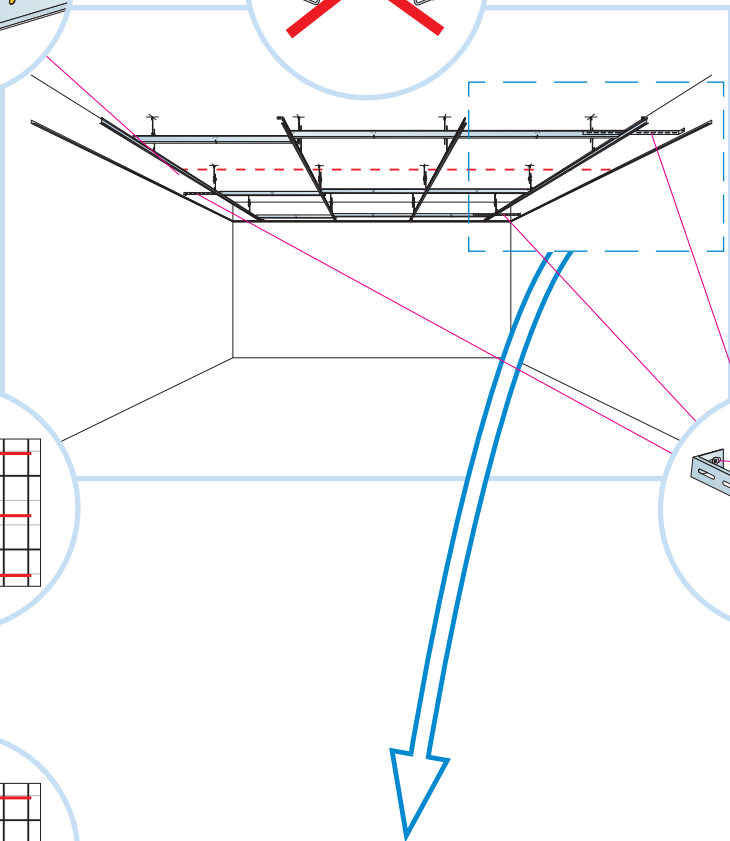

**≤300  
(12")**

**1500  
(60")**

**≤300  
(12")**

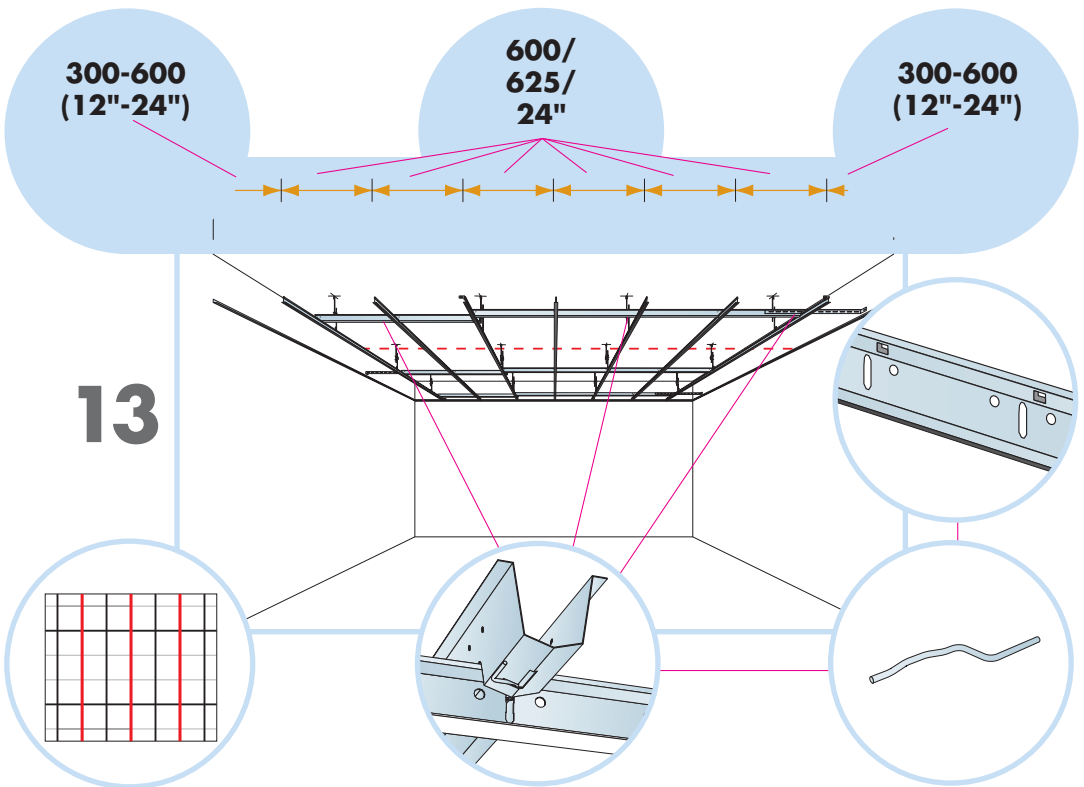
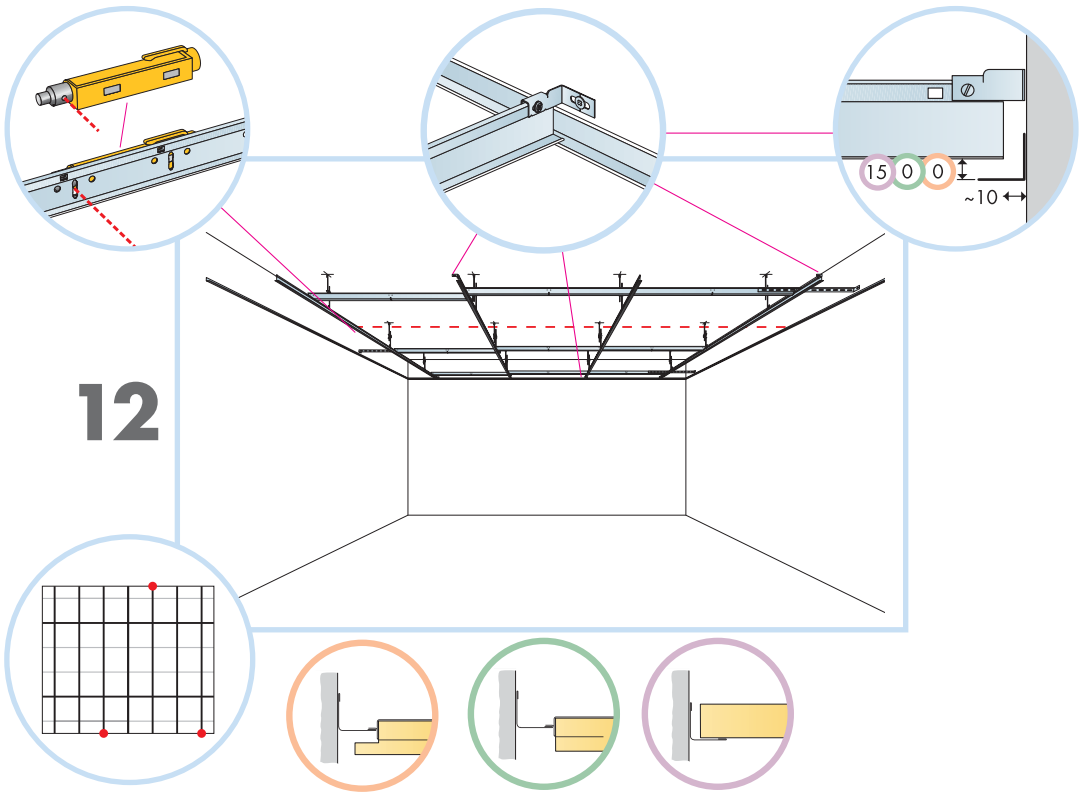

□ **600x600/  
625x625/  
24"x24"** → **13**

□ **1200x600/  
1250x625/  
48"x24"** → **18**

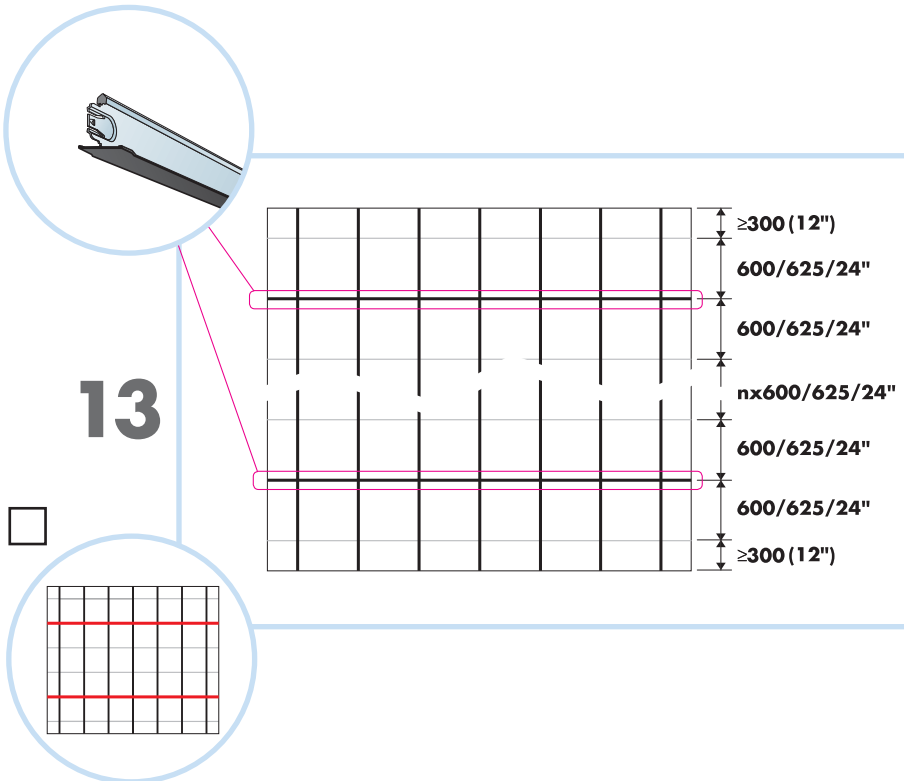

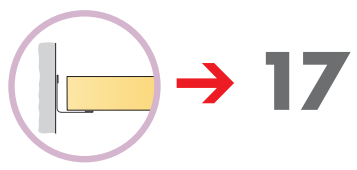
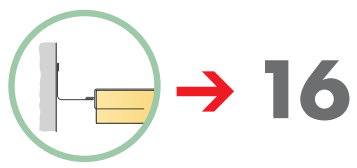
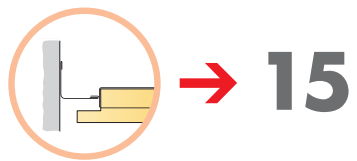
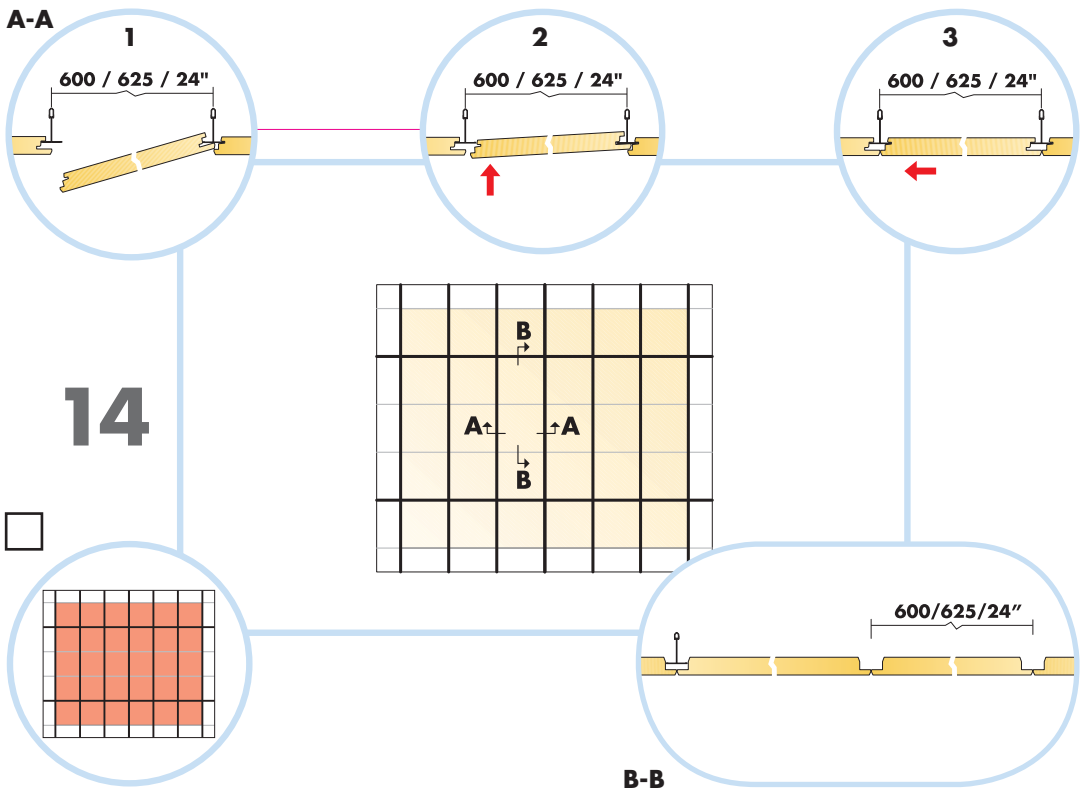

Cutting tool 0991

C-C

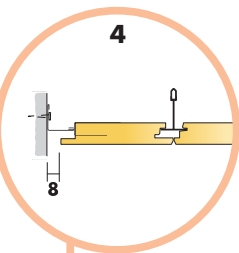
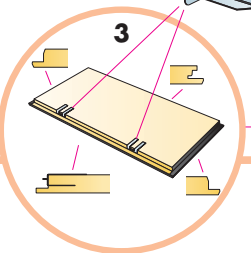
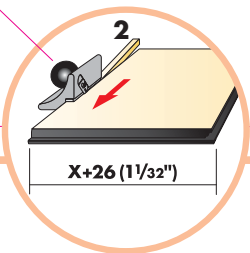
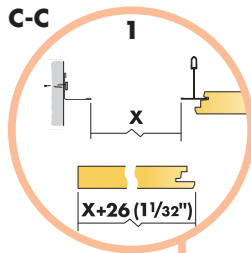

15

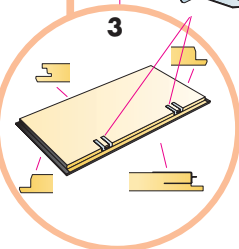
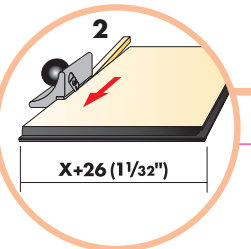
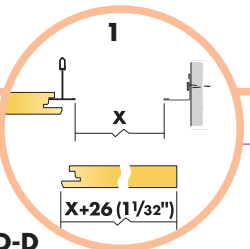
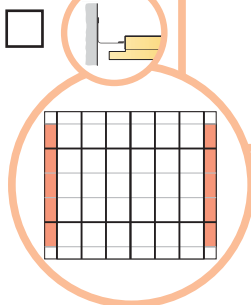
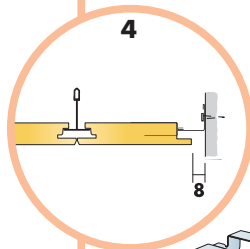
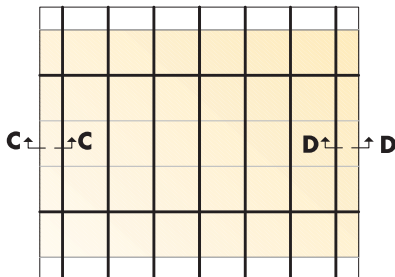

D-D

E-E

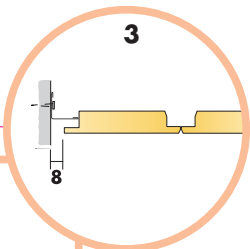
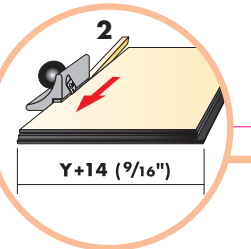
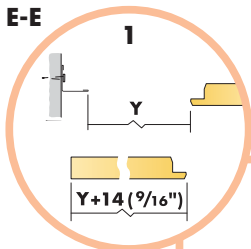

15'

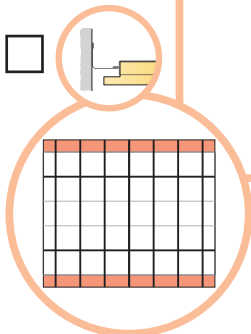
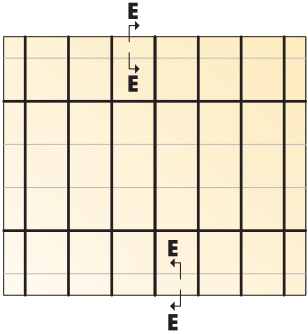

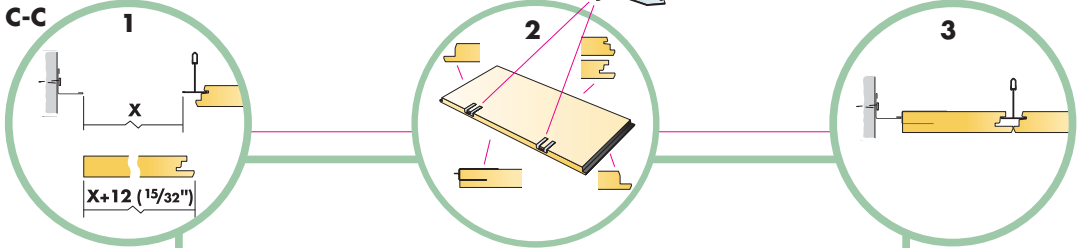

**16**

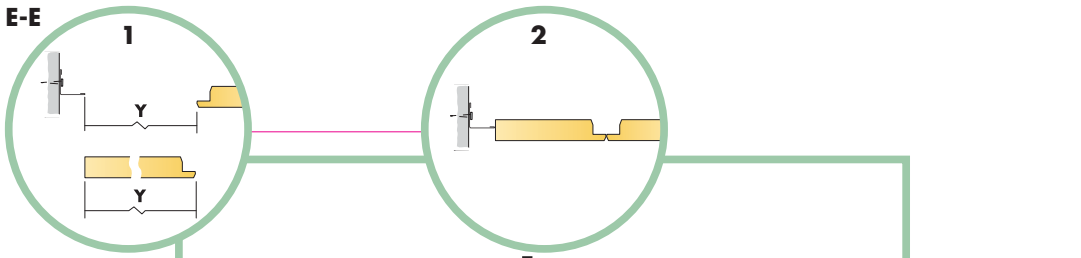
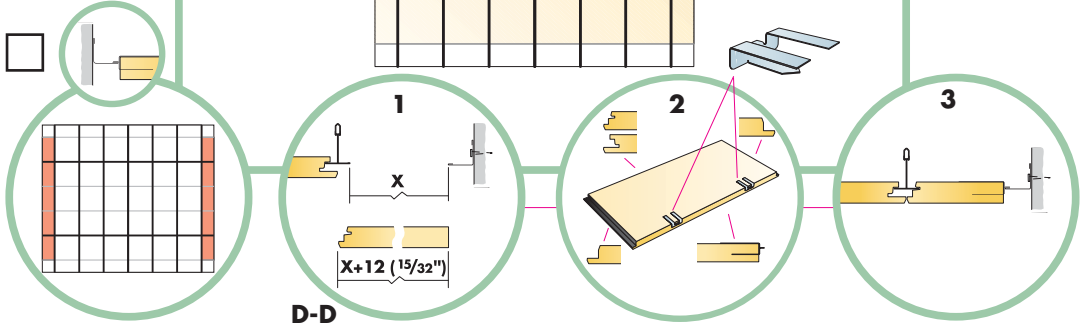
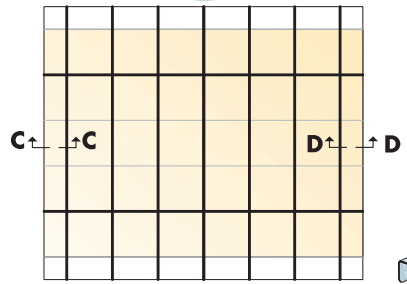

**16<sup>1</sup>**

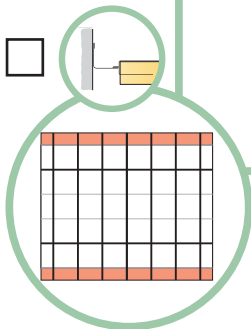
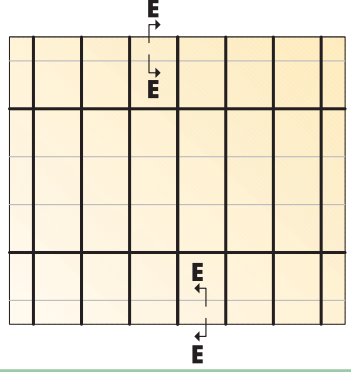

C-C

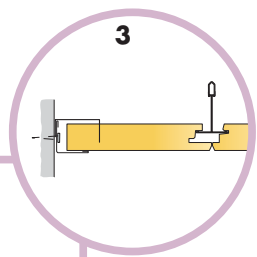
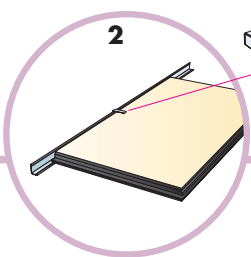
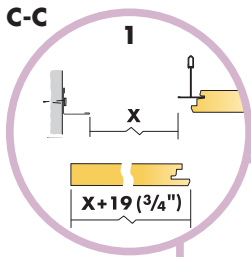

17

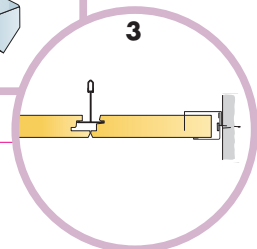
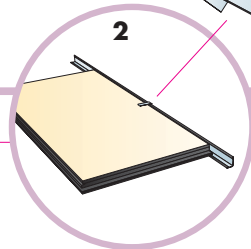
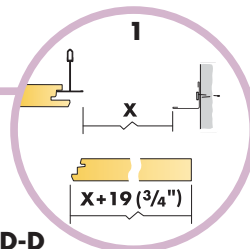
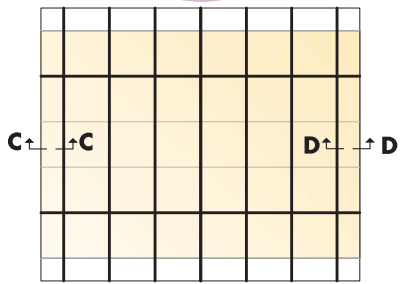
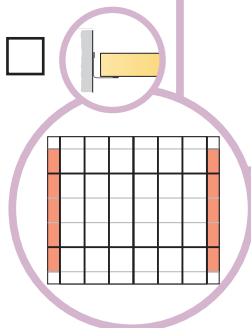

D-D

E-E

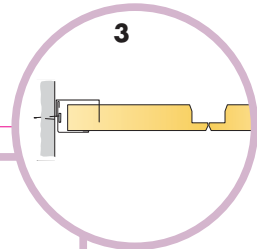
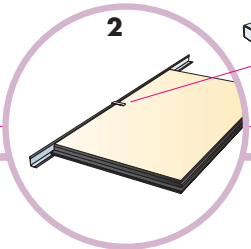
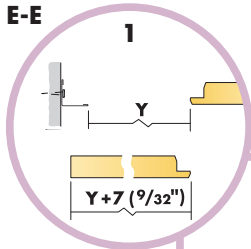

17<sup>1</sup>

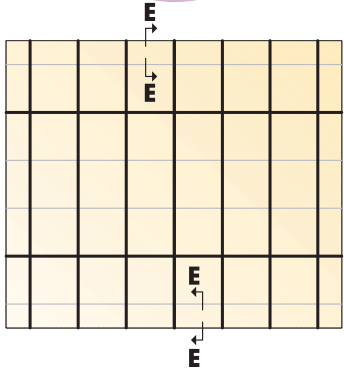
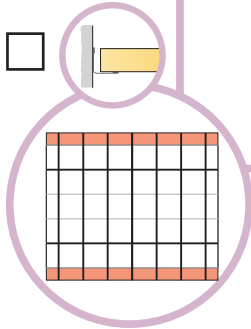

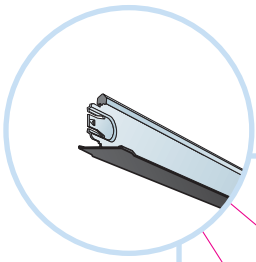

18

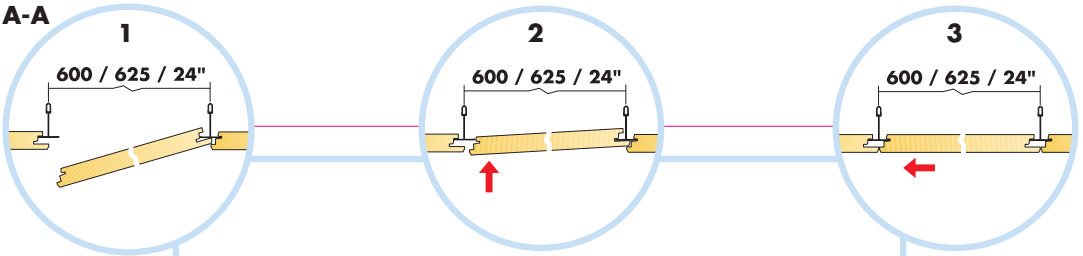
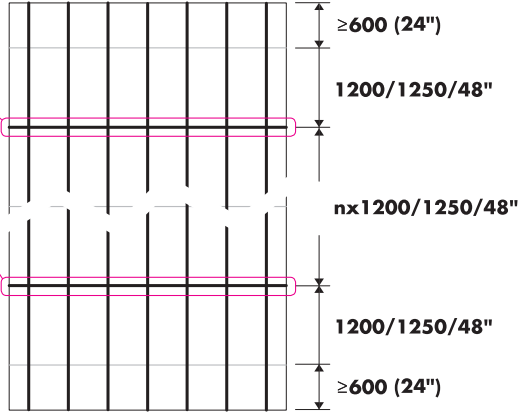
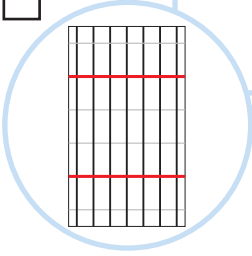

19

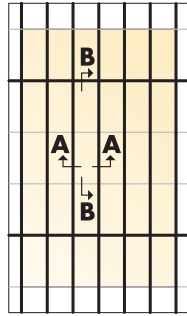
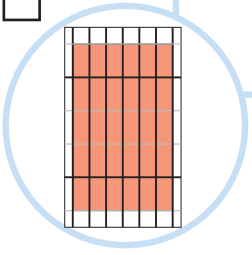

B-B

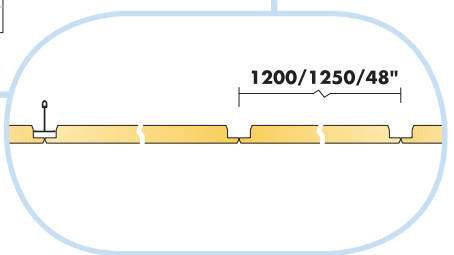

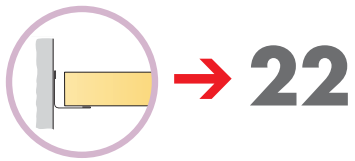
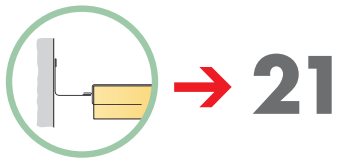
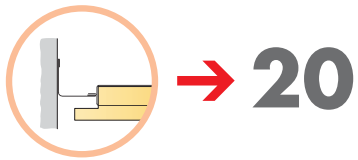

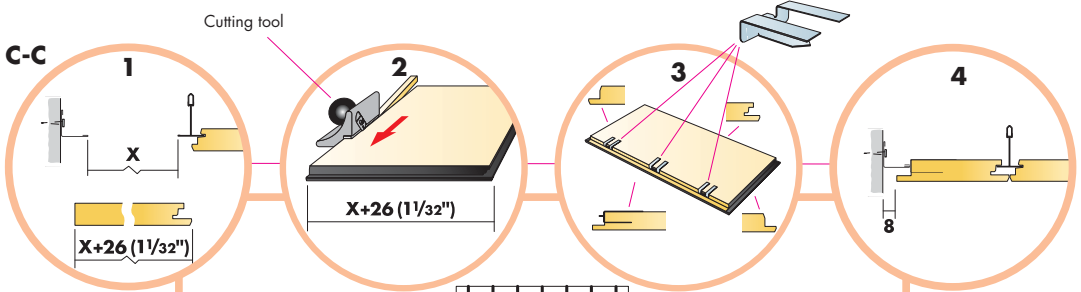

**20**

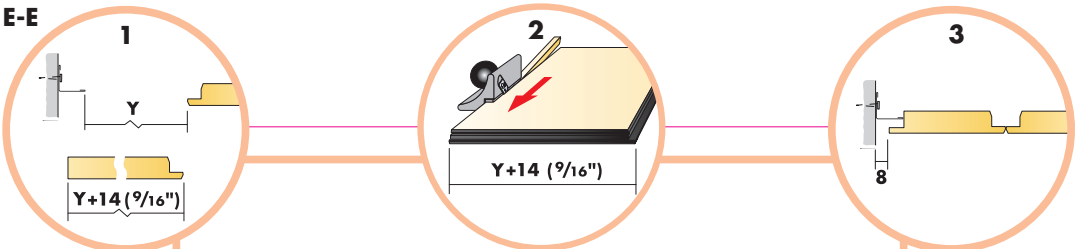
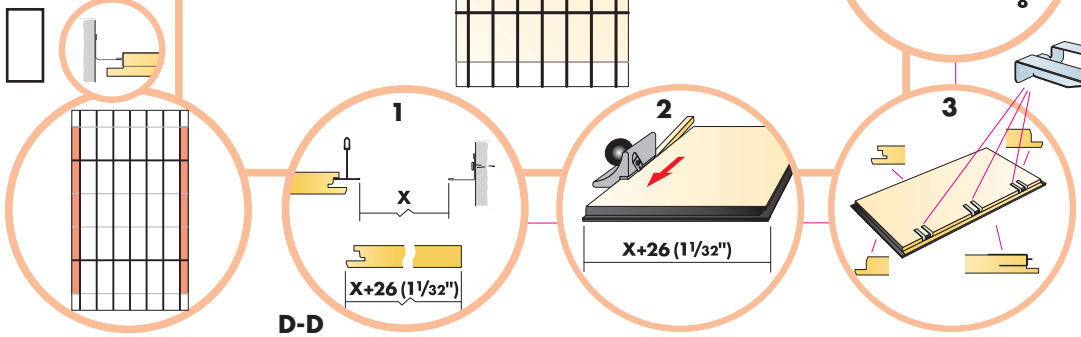

**20<sup>1</sup>**

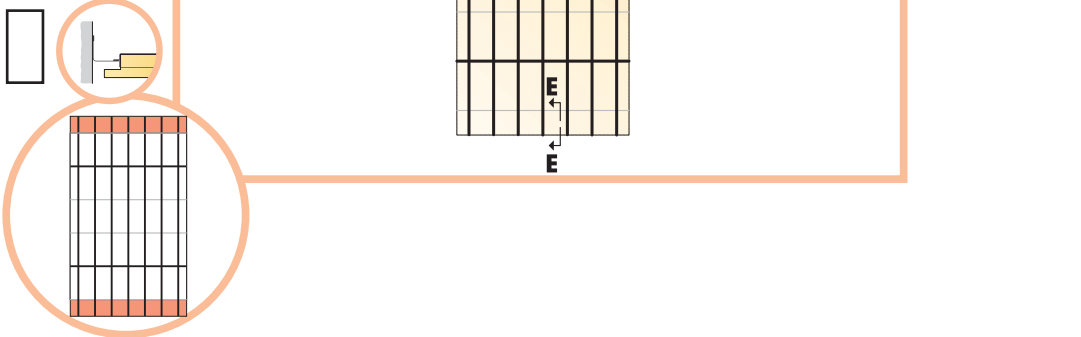

C-C

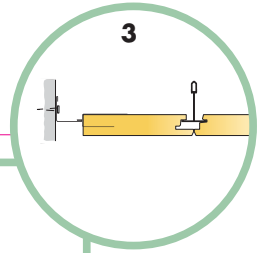
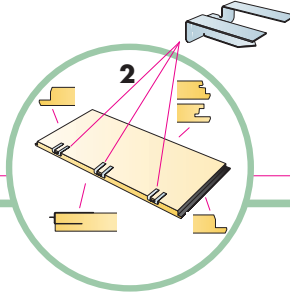
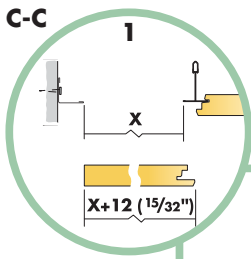

21

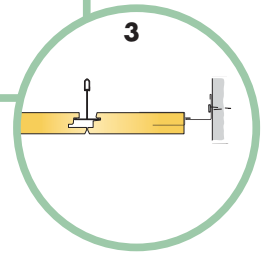
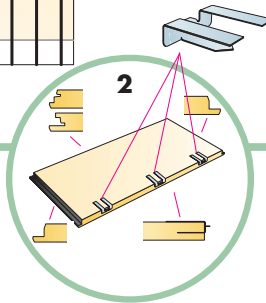
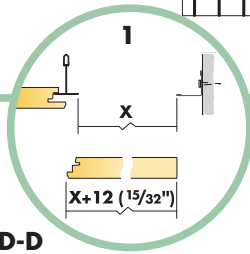
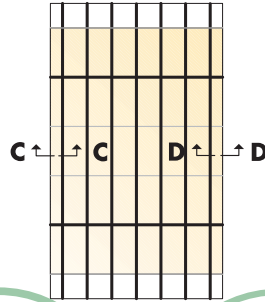
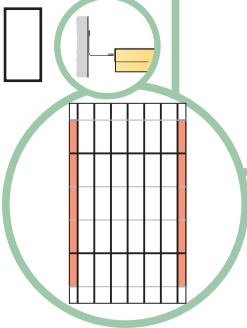

D-D

E-E

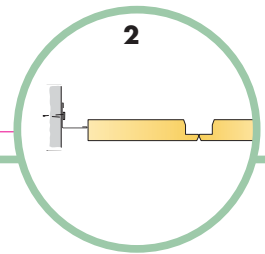
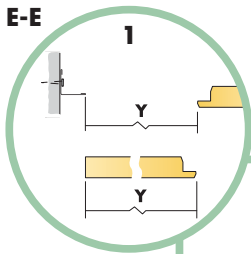

21'

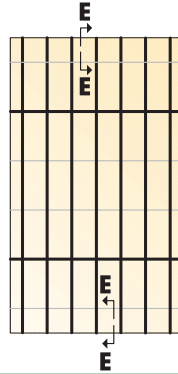
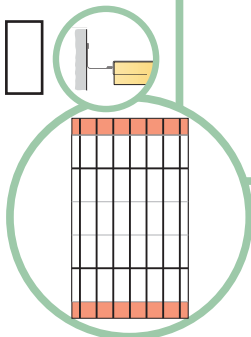

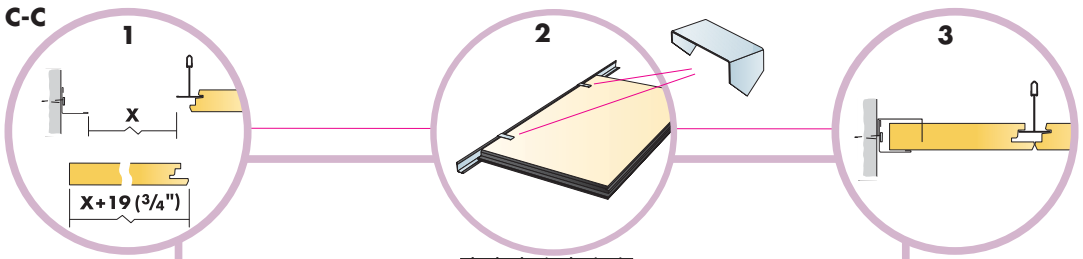

**22**

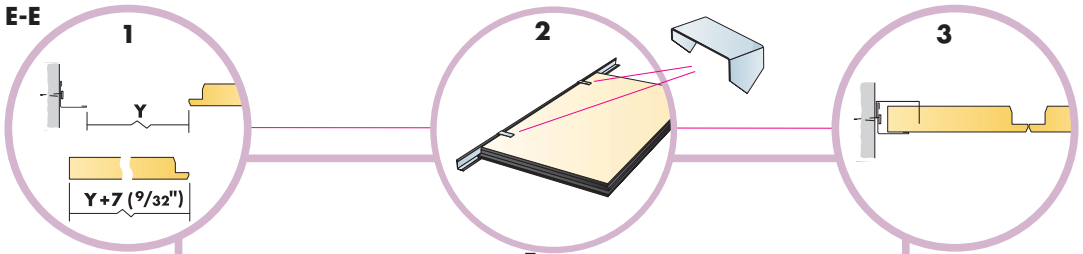
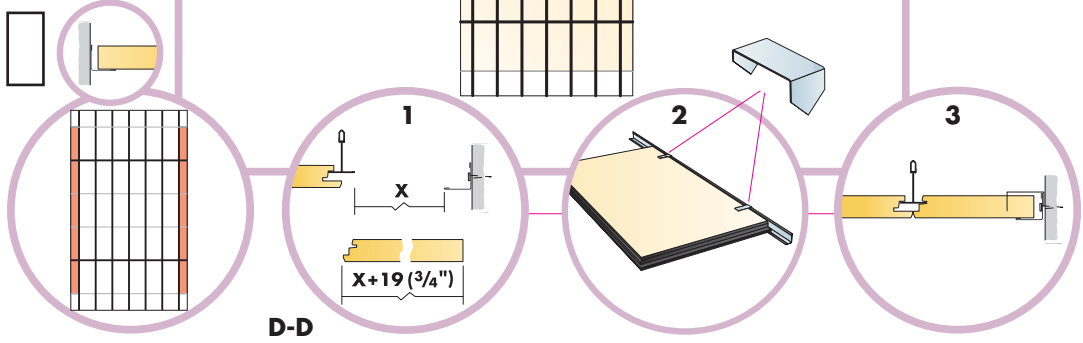

**22<sup>1</sup>**

