

Ecophon Solo[™] Circle

Ø1200
M282

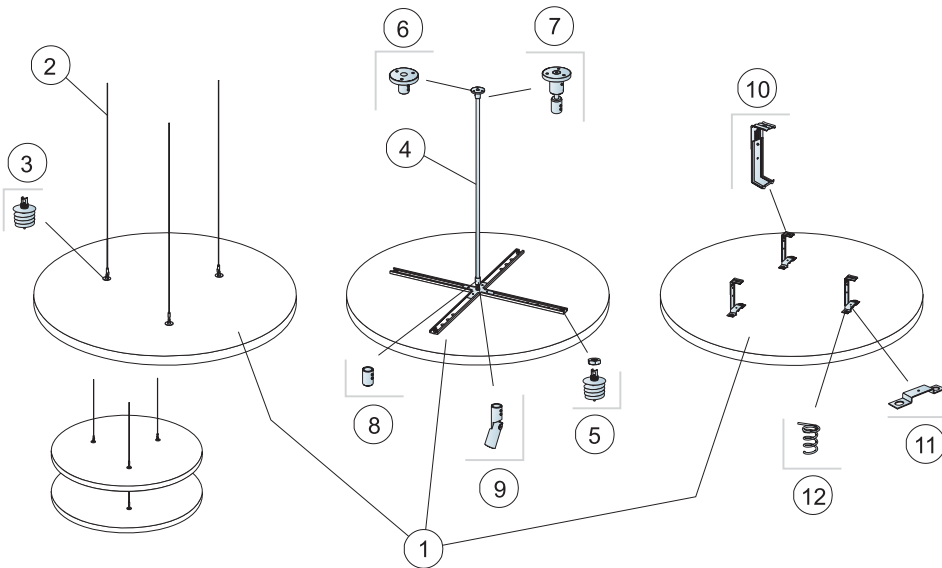
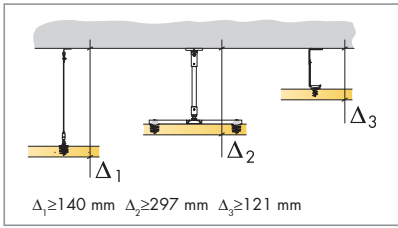

1. Ecophon Solo Circle Ø1200

2. Connect Adjustable wire hanger

3. Connect Absorber anchor

4. Connect Rigid hanger

5. Connect Absorber anchor

6. Connect Soffit fixing

7. Connect Adjust soffit fixing

8. Connect Panel fixing

9. Connect Panel angle fixing

10. Connect Adjust bracket

11. Connect Fixing plate

12. Connect Spiral anchor flat

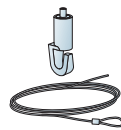

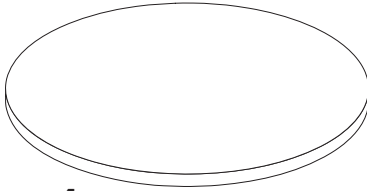
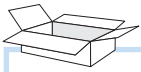

x4

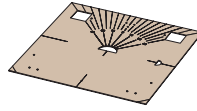

x1



Connect Anchor screw with eye

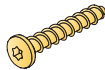

Connect Anchor screw

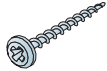

Connect Installation screw MWL

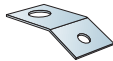

Connect Fixing plate C3



Connect Covering cup

Ecophon[®]
SAINT-GOBAIN

A SOUND EFFECT ON PEOPLE

www.ecophon.com

Alt 1

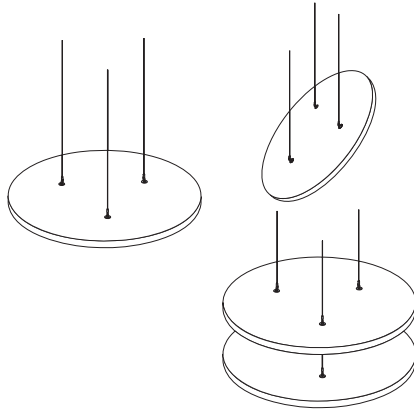

→ 1

Alt 2

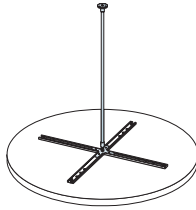

→ 11

Alt 3

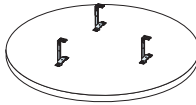

→ 21

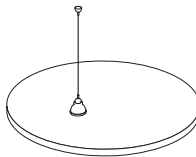

→ 27

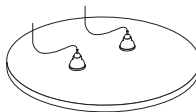

→ 30

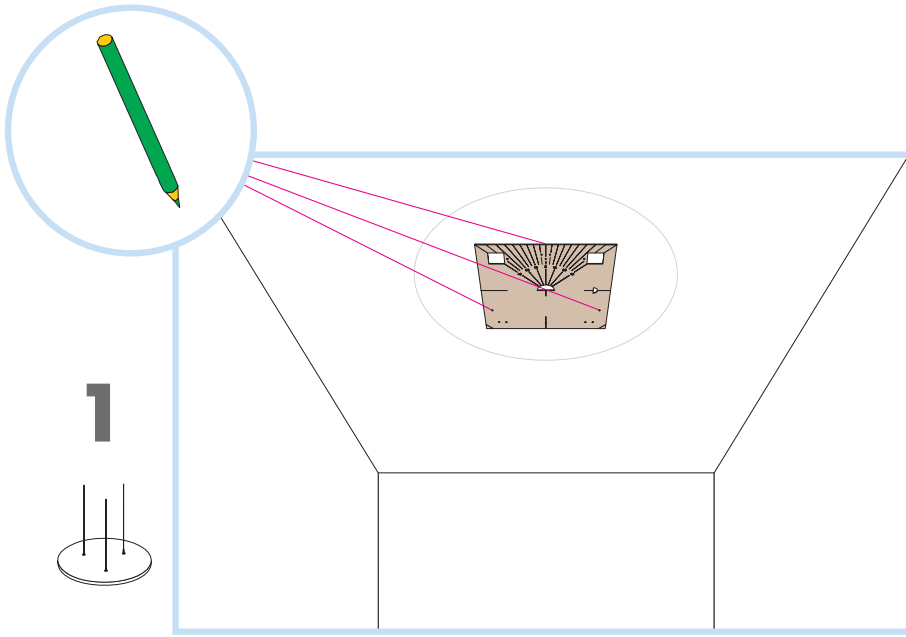

1

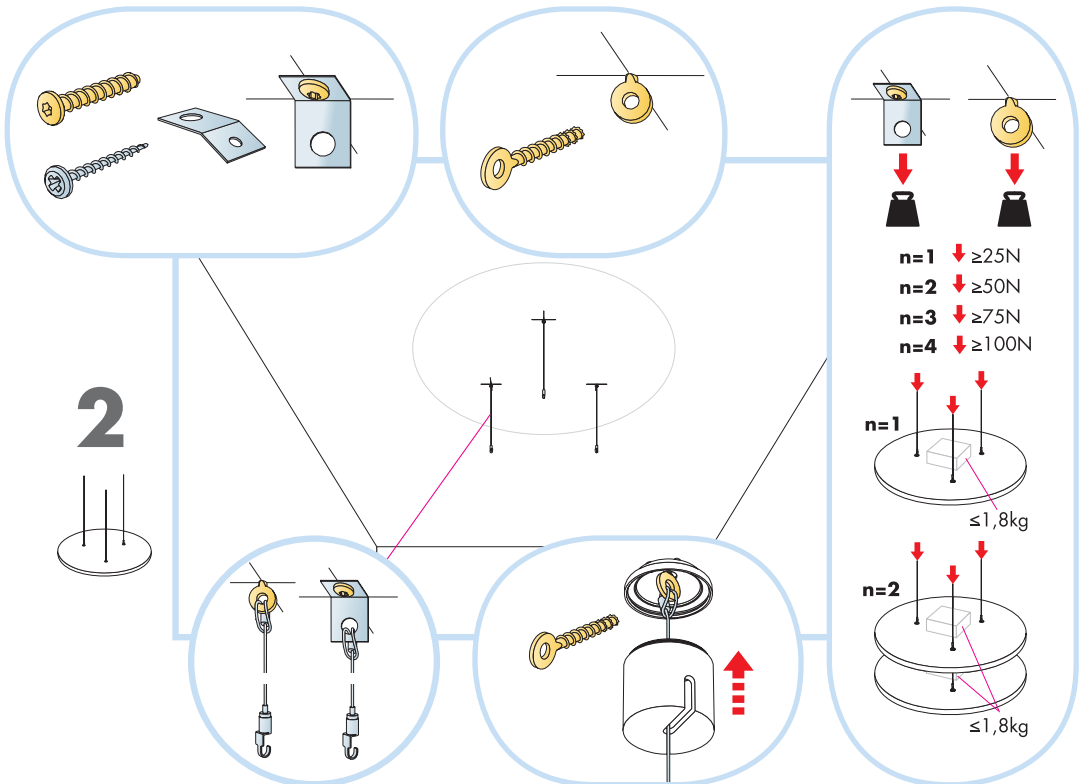
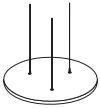

2

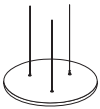

- n=1 ↓ ≥25N
- n=2 ↓ ≥50N
- n=3 ↓ ≥75N
- n=4 ↓ ≥100N

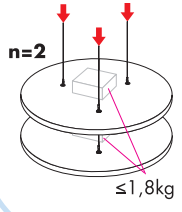
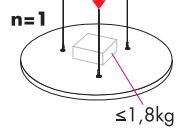

3

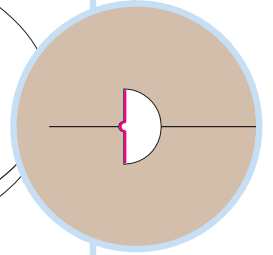
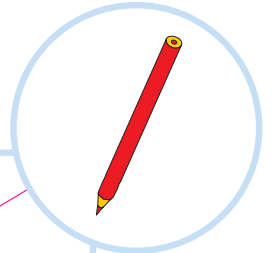
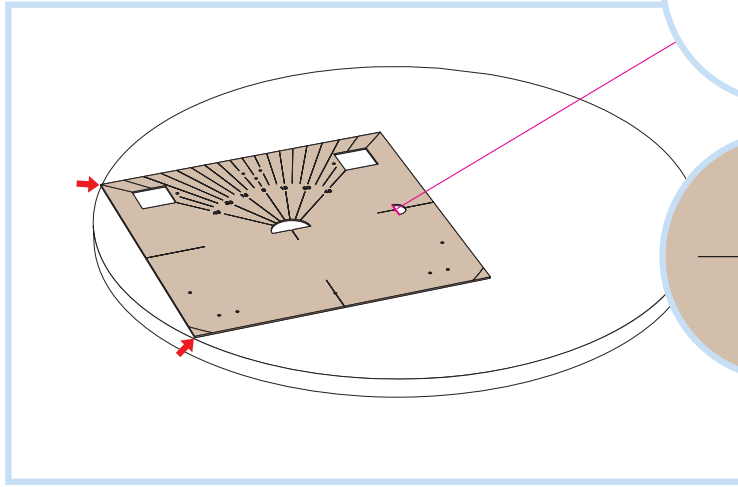
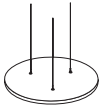

4

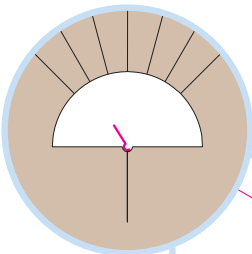
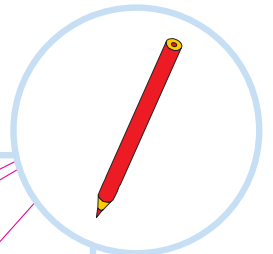
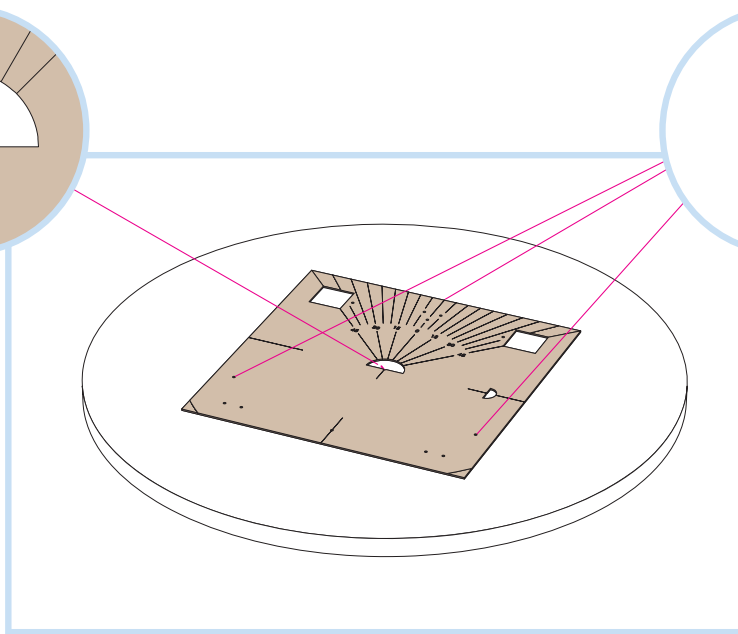
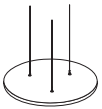

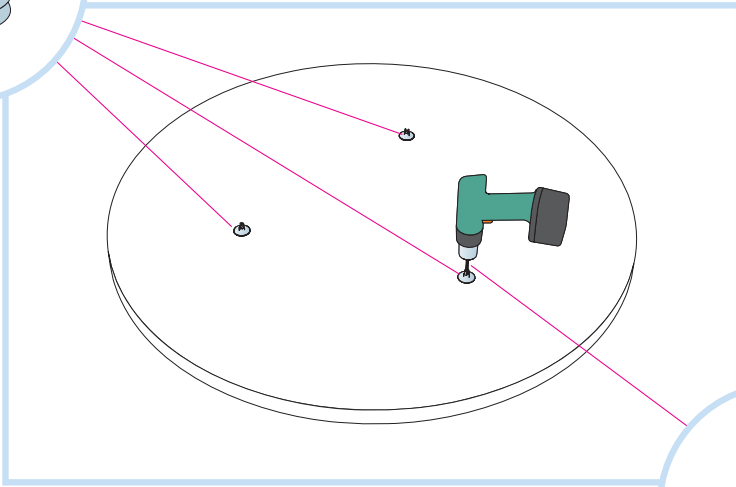
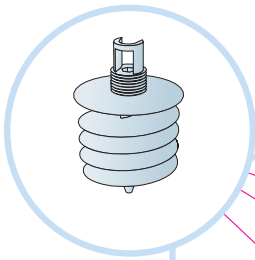

5

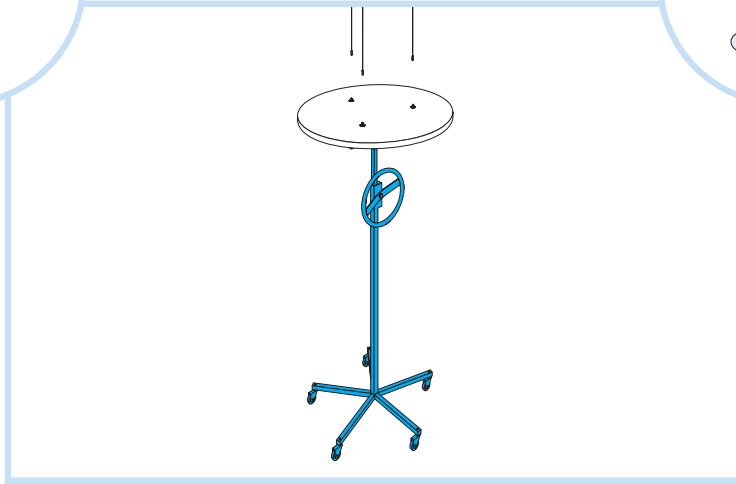
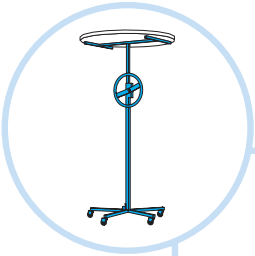
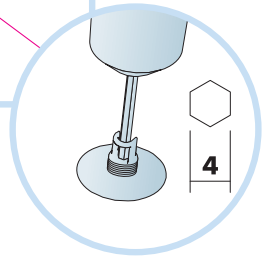
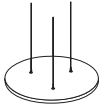

6

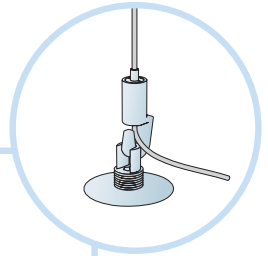
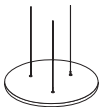

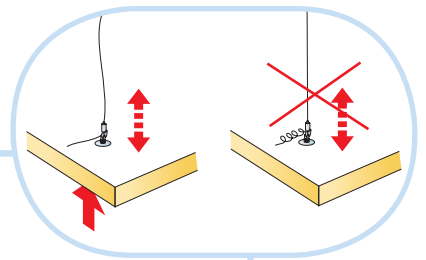
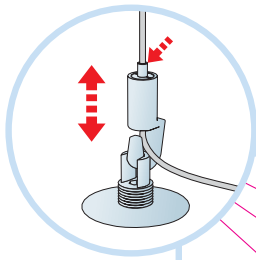

7

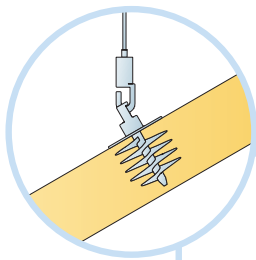
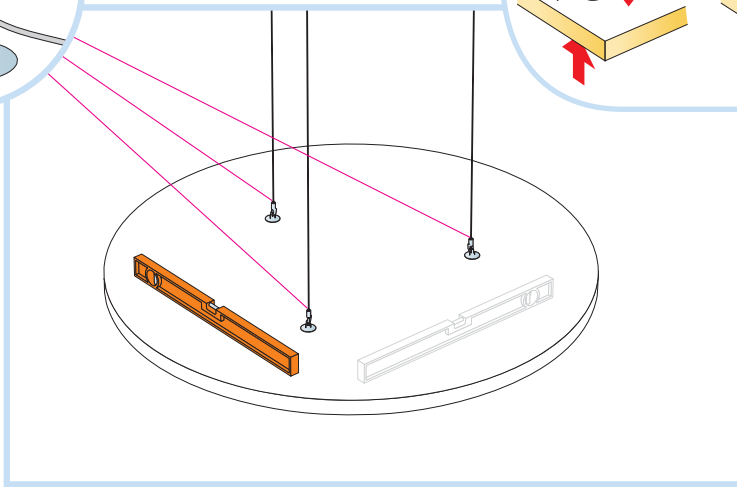
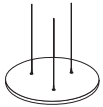

α	L
15°	435
30°	390
45°	320
60°	225

8

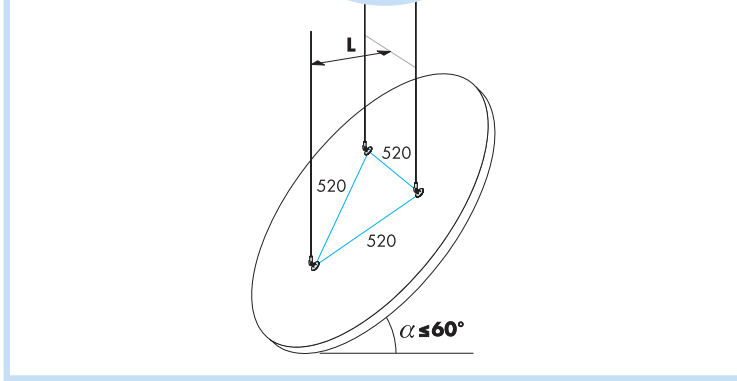
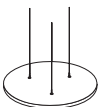

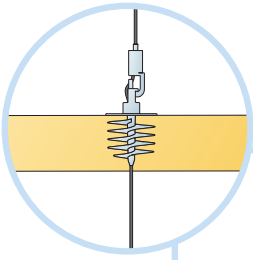

9

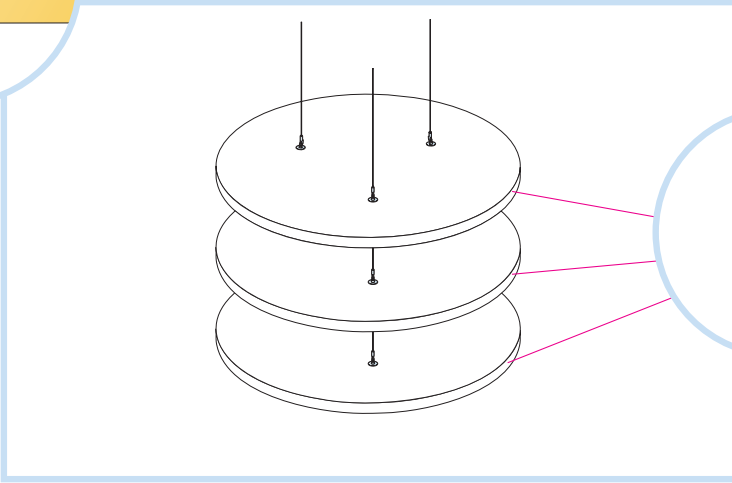
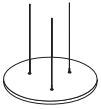

≤ 4

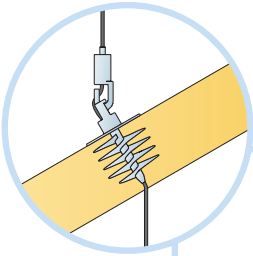

10

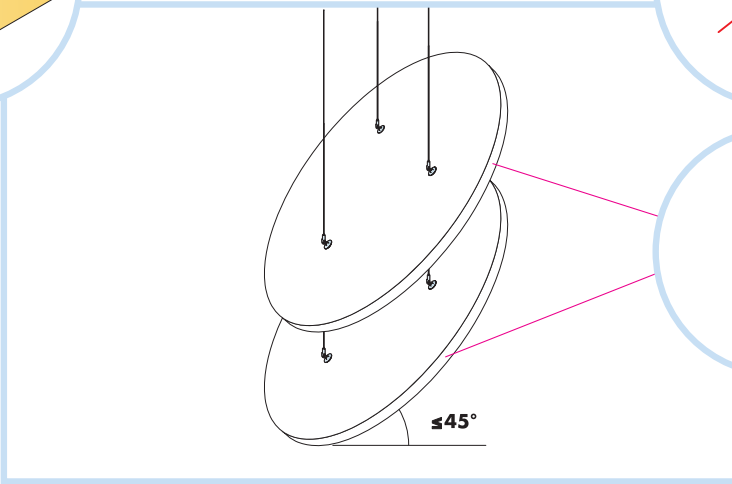
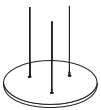

≤ 3

$\leq 45^\circ$

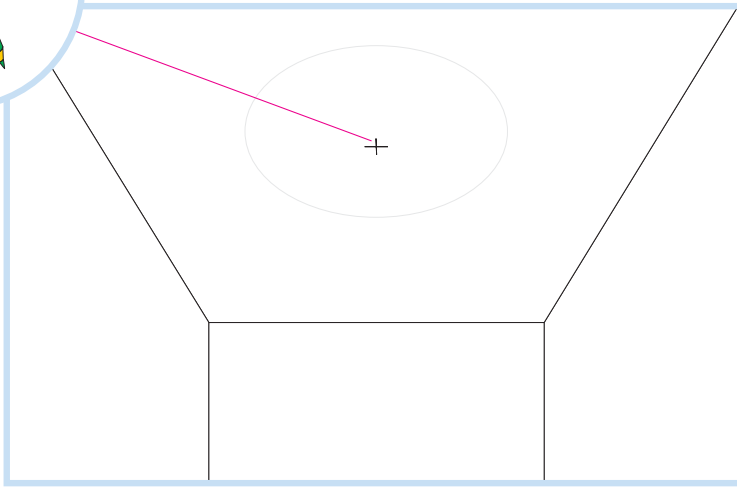
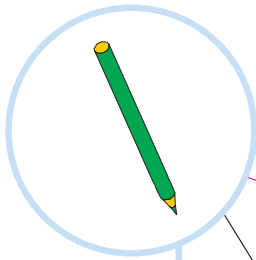

11

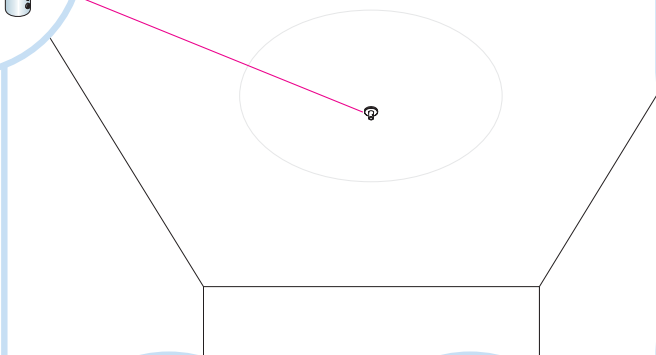
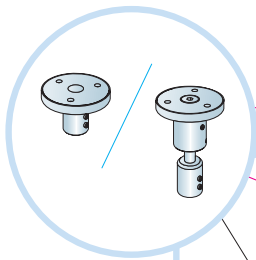

12

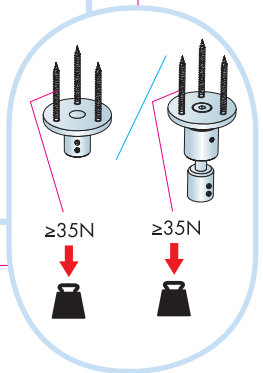
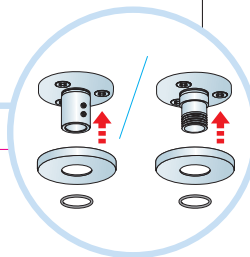
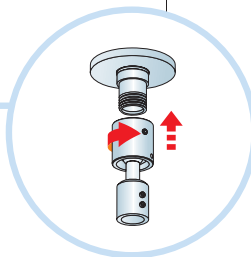
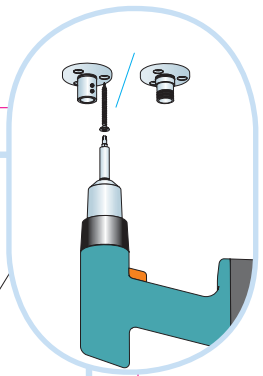

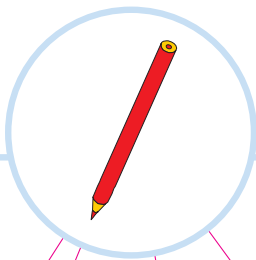
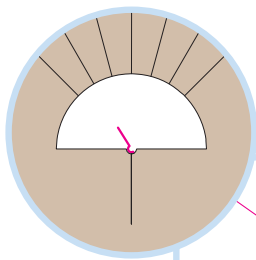

15

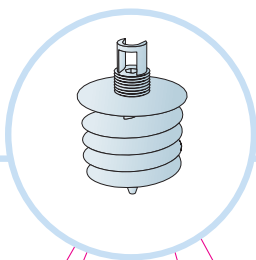
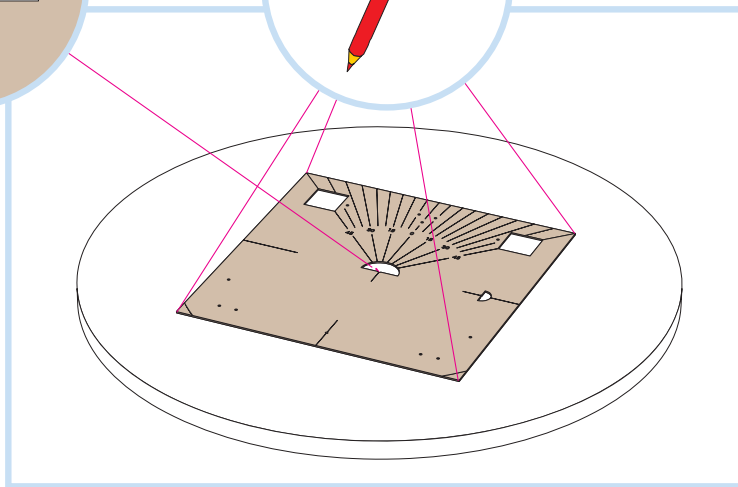

16

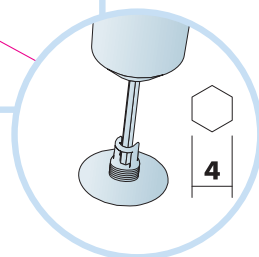
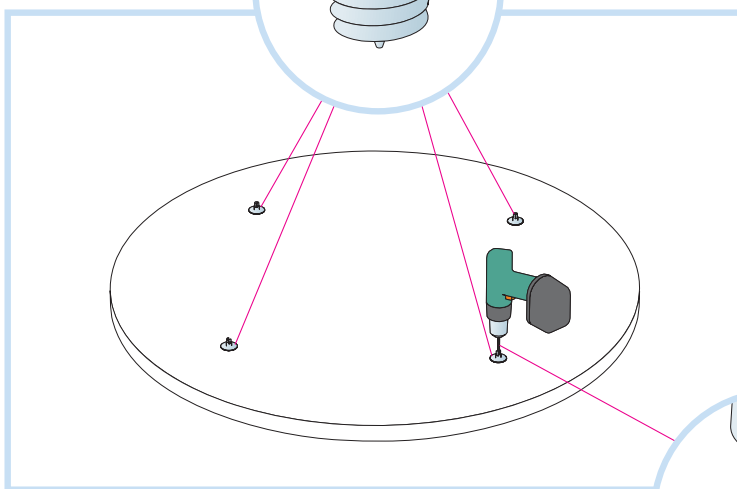

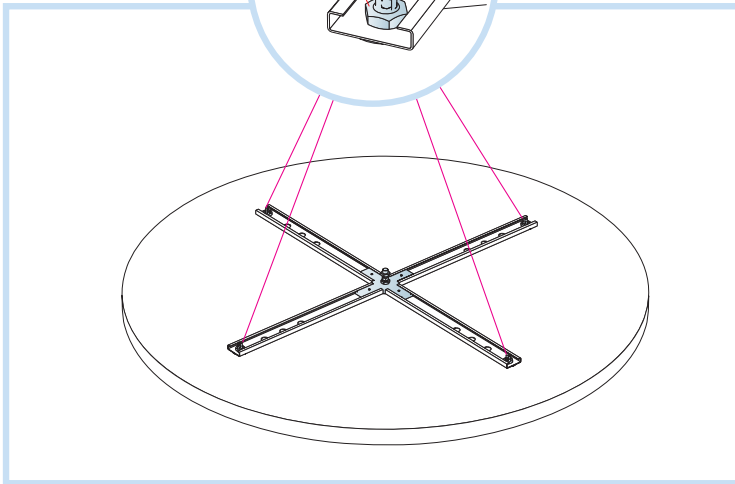
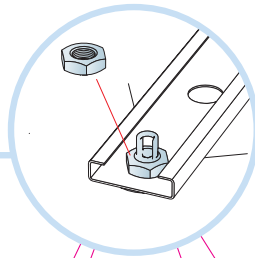
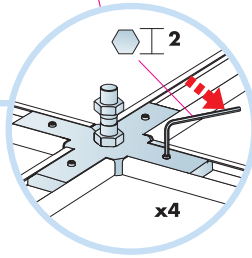
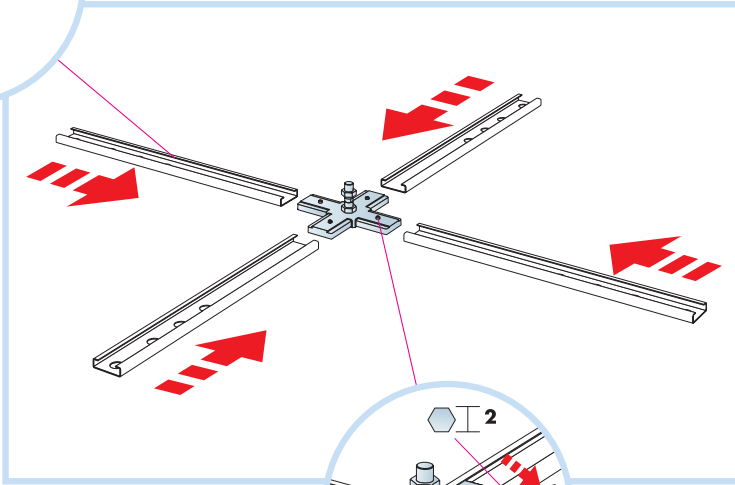
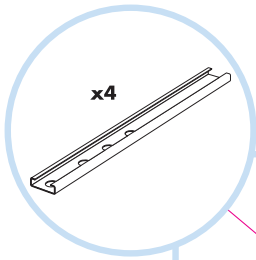

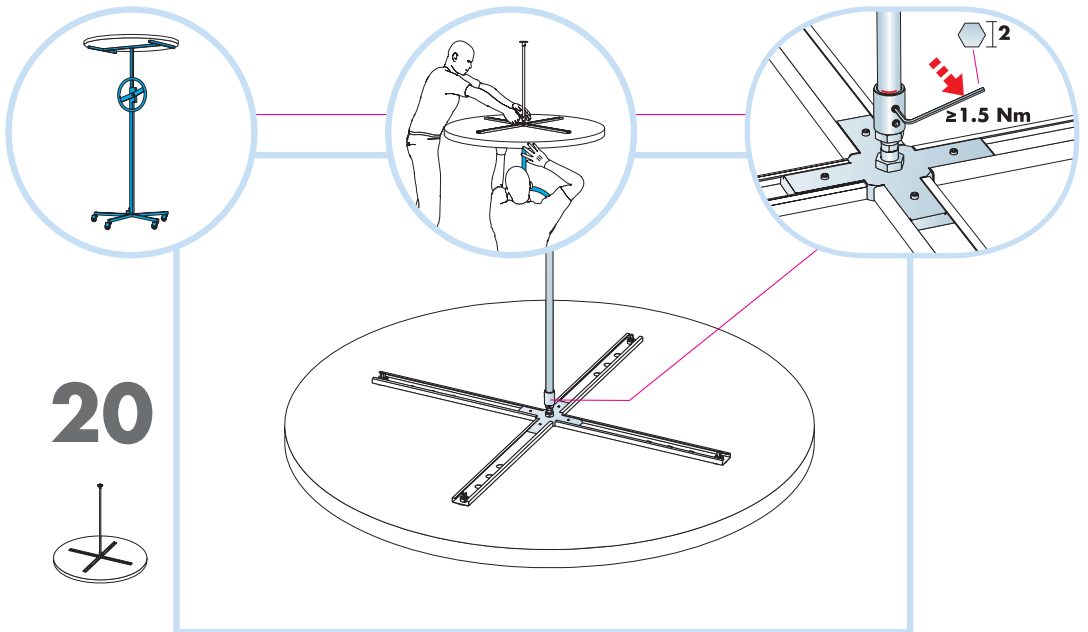
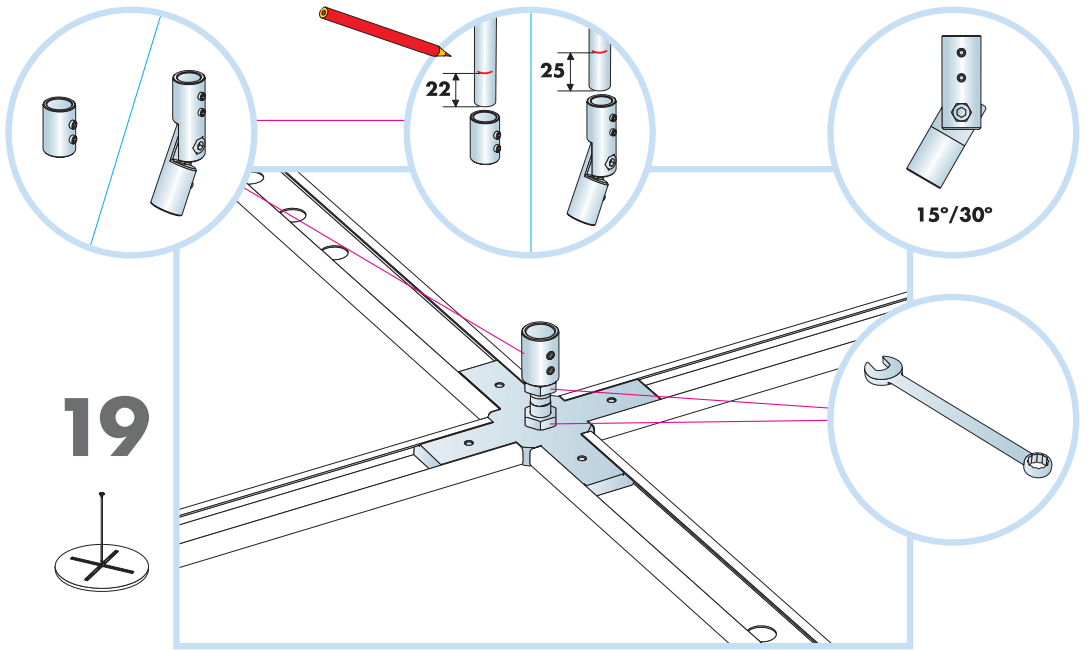

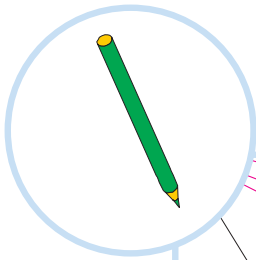

21

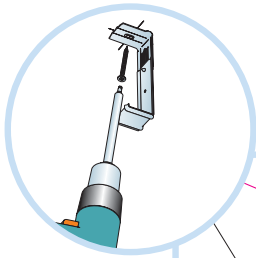
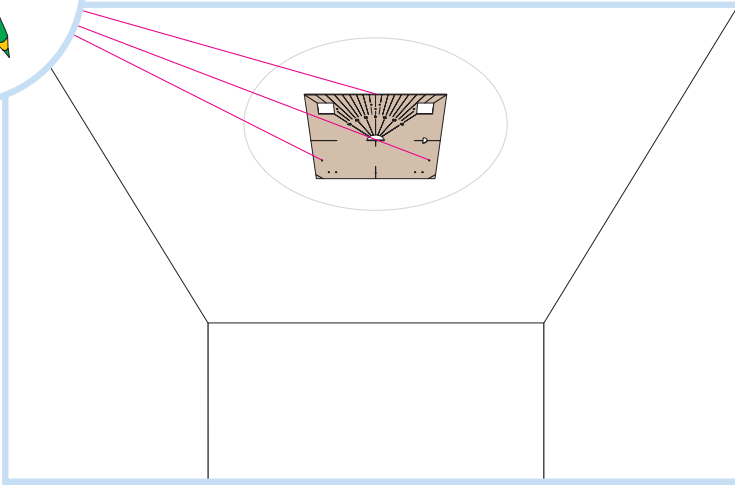

22

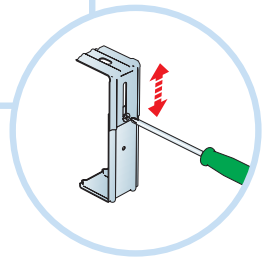
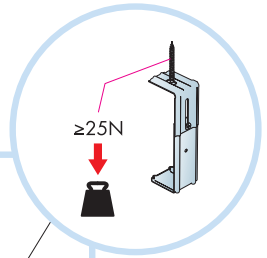
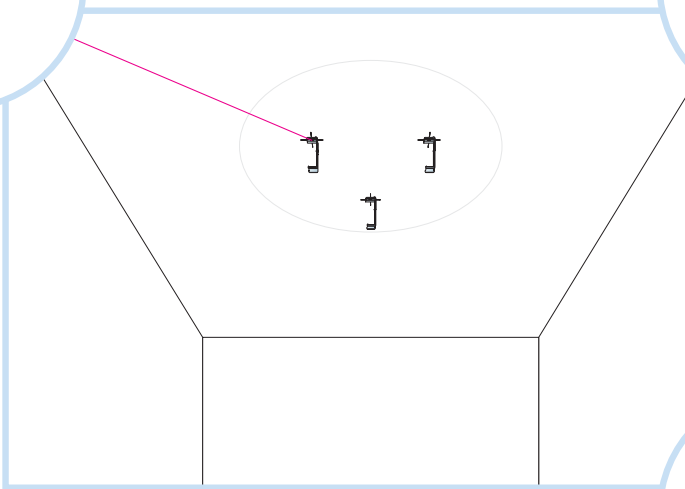

23

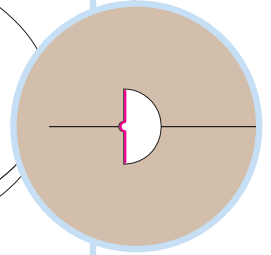
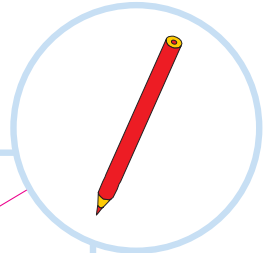
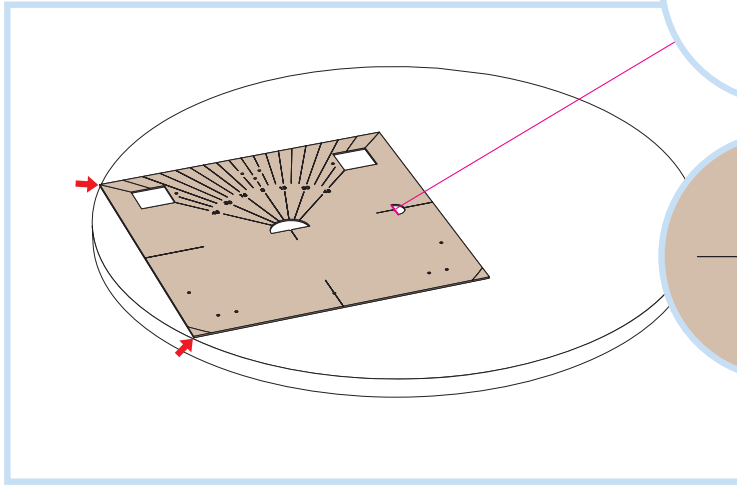

24

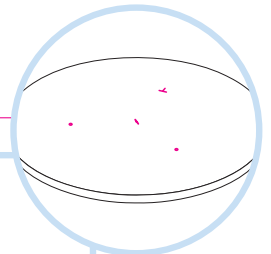
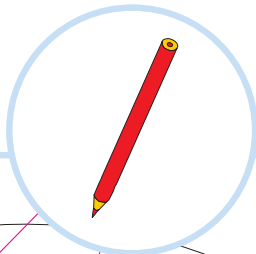
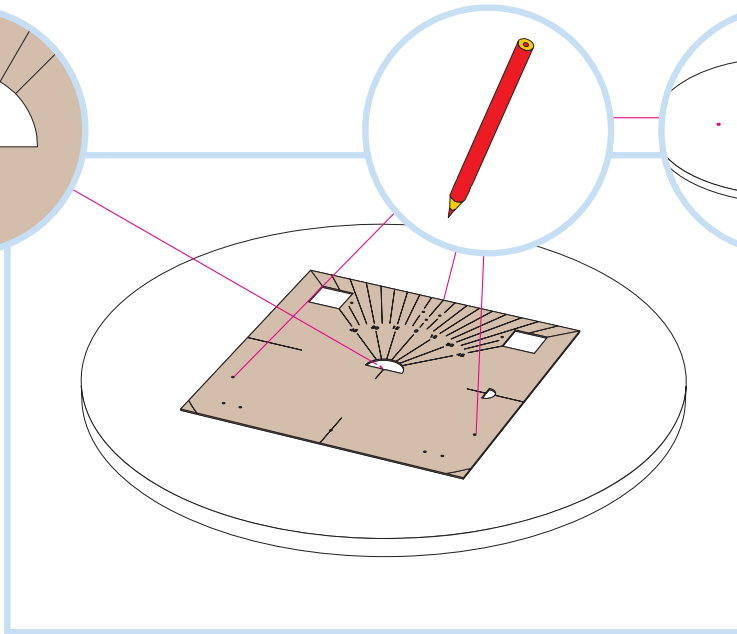

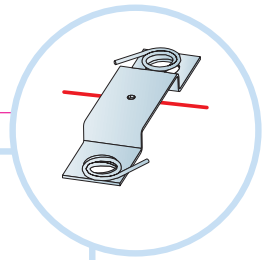
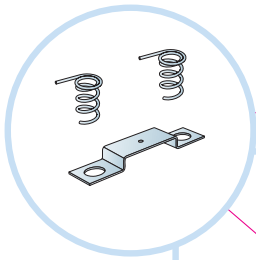

25

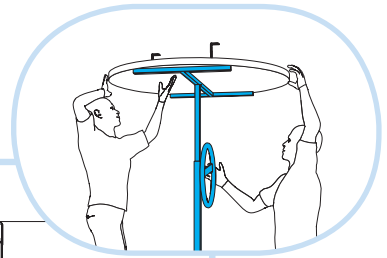
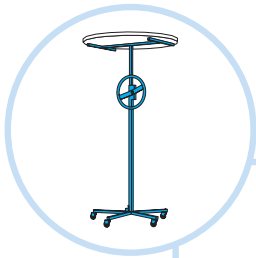
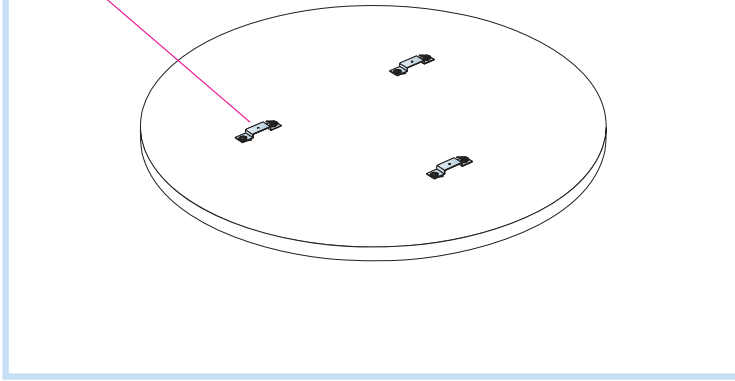

26

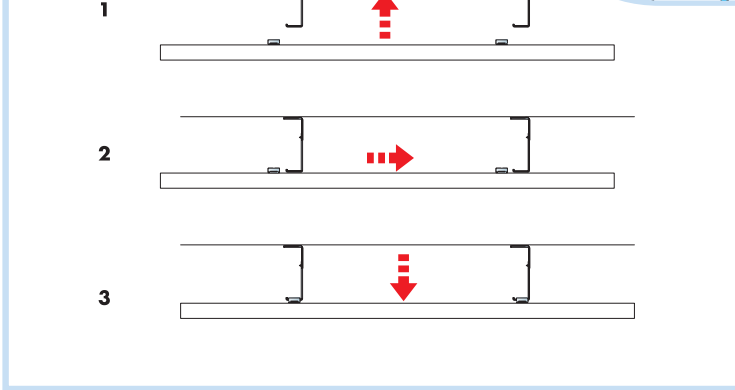

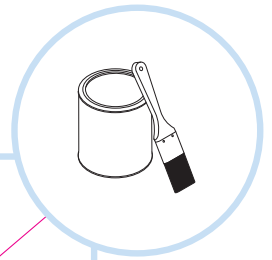
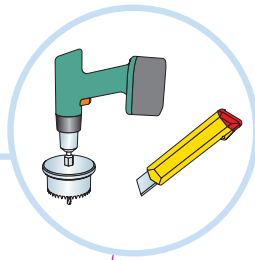
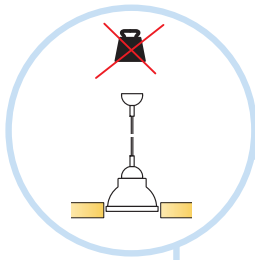

27

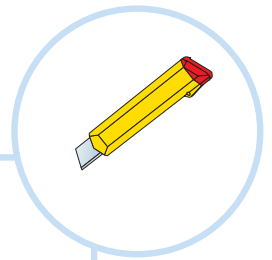
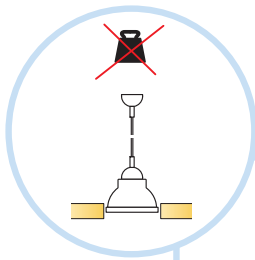
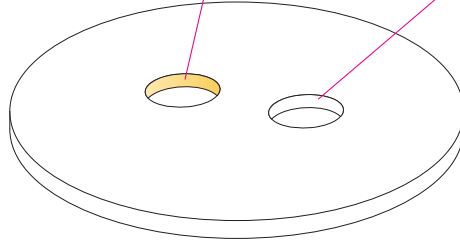

28

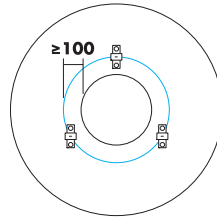
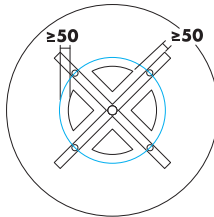
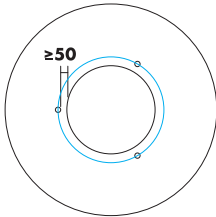
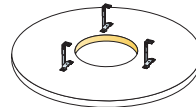
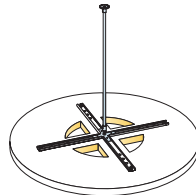
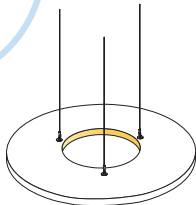

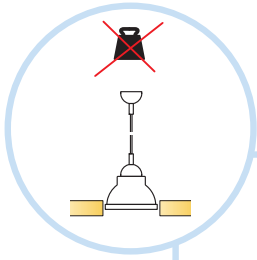

29

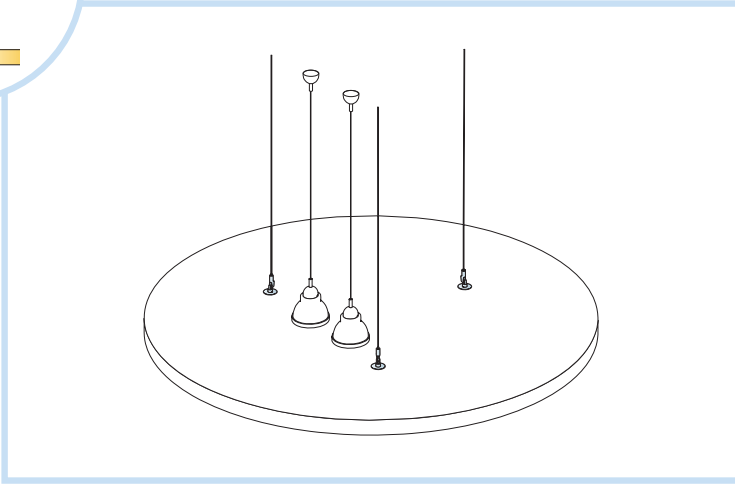

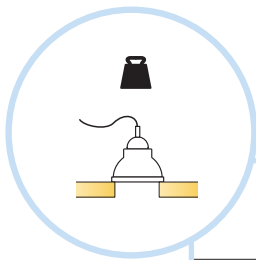

30

	$\leq 100\text{mm}$	$101-300\text{mm}$	$301-500\text{mm}$
	$\geq 150\text{mm}$	$\geq 150\text{mm}$	-
	$\leq 0,5\text{kg}$	$\leq 1,5\text{kg}$	$\leq 1,5\text{kg}$
<p>▲+▲+▲+...</p>	$\leq 1,8\text{kg}$	$\leq 1,8\text{kg}$	$\leq 1,5\text{kg}$

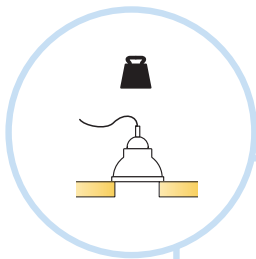

31

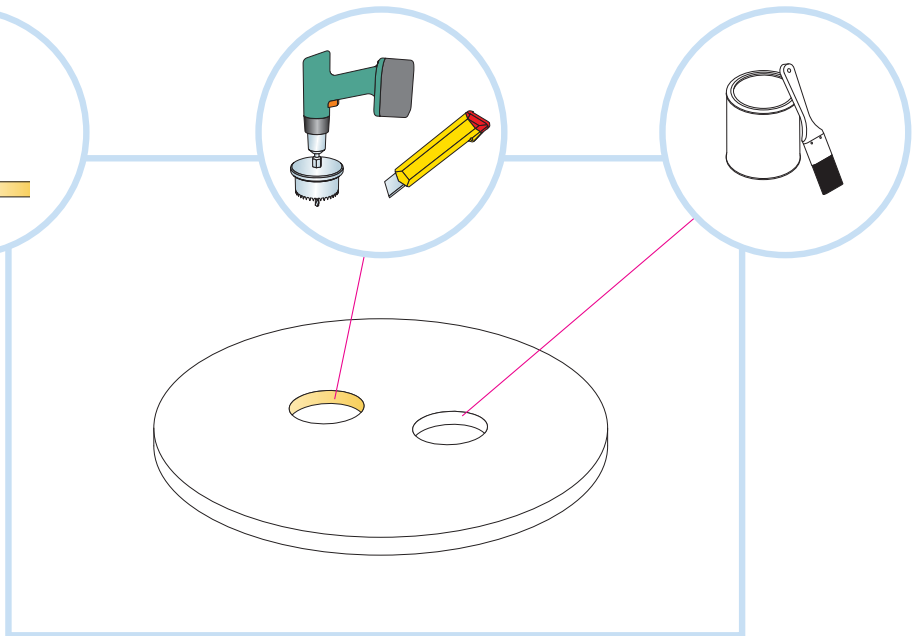

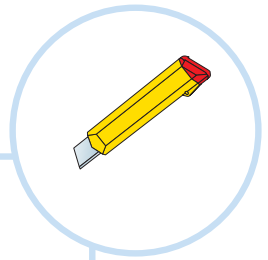
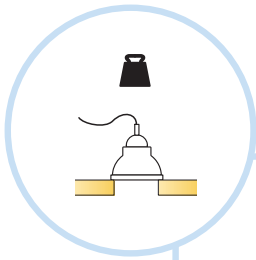

32

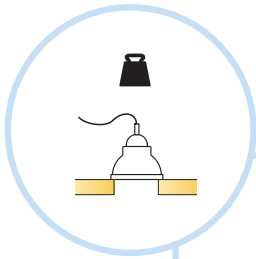
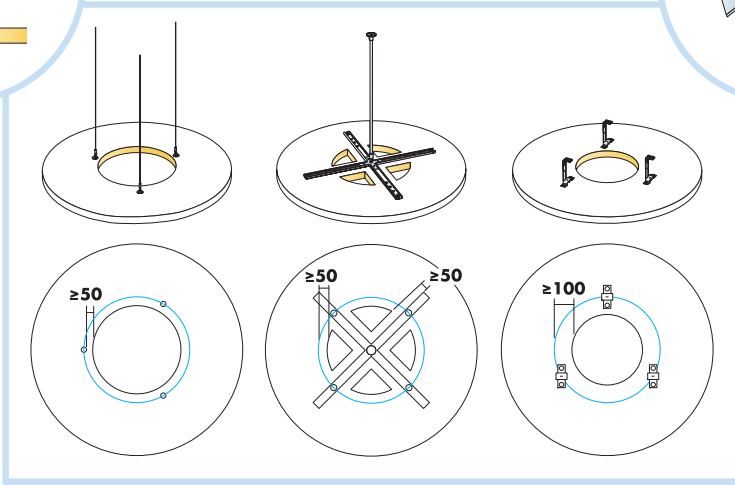

33

