

 DELTALIGHT®

the
lighting
bible®

New
Collection
2014-2015



pure
lighting
pleasure



Download the Lighting Bible® 10 app for mobile use.
More information at www.deltalight.com





building **the future**

Delta Light HQ / Belgium / 2014-2015





INTERIOR LIGHTING

Delta Light offers a very extensive range of ceiling recessed lighting solutions for a wide range of ceiling conditions. Be it for general lighting, wall wash, accent, flood or diffused lighting, all recessed luminaires are designed to combine the light source with the best optics, reflectors and lenses to combine light quality and energy efficiency, helping you to apply the best lighting solutions for the intended purpose of the space. The following range completes the Lighting Bible 10 interior collection.







iMAX®
PAG 18



MINI SPY
PAG 52



CARREE R_s LED
PAG 66



PITCH 162
PAG 74



GABOO W
PAG 80



iMAX® ADJUSTABLE
PAG 26



SPY
PAG 54



CARREE 150 LED
PAG 68



BOOSTER HP
PAG 76



POGO
PAG 82



iMAX® ADJUSTABLE TRIMLESS
PAG 34



DIRO TRIMLESS LED
PAG 59



GRID IN HP
PAG 70



SUPERDOME
PAG 78



FORTY-5
PAG 84



iMAX® WALLWASH
PAG 42



DIRO DUO ST OK LED
PAG 59



GABOO C
PAG 80



BACKSPACE LED
PAG 86



iMAX®+
PAG 46



CARREE OK LED
PAG 60

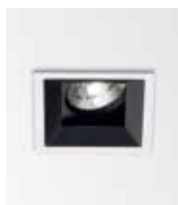

CARREE SC OK
PAG 64



YOU-TURN ON REO AD DIM
PAG 90



YOU-TURN ON OPTO AD DIM
PAG 92



BOOSTER HP AD
PAG 94



SUPERNOVA XS PIVOT AD DIM
PAG 96

INTERIOR LIGHTING

BACKSPACE LED	PAG 86
BOOSTER HP	PAG 76
BOOSTER HP AD	PAG 94
CARREE 150 LED	PAG 68
CARREE OK LED	PAG 60
CARREE R8 LED	PAG 66
CARREE SC OK	PAG 64
DIRO DUO ST OK LED	PAG 59
DIRO TRIMLESS LED	PAG 59
FORTY-5	PAG 84
GABOO C	PAG 80
GABOO W	PAG 80
GRID IN HP	PAG 70
iMAX®	PAG 18
iMAX® +	PAG 46
iMAX® ADJUSTABLE	PAG 26
iMAX® ADJUSTABLE TRIMLESS	PAG 34
iMAX® WALLWASH	PAG 42
MINI SPY	PAG 52
PITCH 162	PAG 74
POGO	PAG 82
SPY	PAG 54
SUPERDOME	PAG 78
SUPERNOVA XS PIVOT AD DIM	PAG 96
YOU-TURN ON OPTO AD DIM	PAG 92
YOU-TURN ON REO AD DIM	PAG 90

SOFT CEILING®

INTRO

The Soft Ceiling® concept enables you to create discrete but diverse lighting scenographies, using one luminaire type. It allows architects and designers to work with different lighting applications, beams, effects, filters and output levels, using unobtrusive and glare-free fixtures for a zero-sightline ceiling.

Thanks to precise engineering, the use of superior reflector materials and a multitude of options, Soft Ceiling® fixtures guarantee optimal optic performance and maximum eye comfort. The vast range of options allow you to work with a Soft Ceiling® luminaire throughout the entire project, meeting the different needs of each room, without unnecessary cluttering of the ceiling.



iMax® / 4 beams / Extreme Narrow (SP-6°), Narrow (SP-10°), Medium (FL-29°) and Wide (WFL-43°)



iMax® Adjustable - Trimless / 4 beams / Extreme Narrow (SP-6°), Narrow (SP-10°), Medium (FL-29°) and Wide (WFL-43°)



iMax® Wallwash / 2 beams / Medium (FL-29°) and Wide (WFL-43°)

iMax®

The iMax® range is the first collection in the Soft Ceiling® concept. The name symbolizes the maximum eye comfort - minimal appearance philosophy, offering a very vast assortment of refined and discrete lighting solutions.

Best lighting quality

The iMax® Soft Ceiling® range is using the most advanced LED engines available, delivering high performance, maximum efficacy and high quality illumination. The collection features different colour temperatures, CRI and output levels, combined with optimal colour consistency.

Throughout all versions specially designed reflectors guarantee uniform illumination and optimal beam alignment. Premium lenses are used to obtain real spot optics and best industry accuracy and quality.

Wet locations

The fixed and adjustable versions in the range are available with a clear glass, offering IP54. This enables you to continue the Soft Ceiling® minimalism and uniformity throughout bathrooms, wellness areas and other indoor damp locations.

Less is more

The Soft Ceiling® concept focuses on minimal appearance, giving stage to the light instead of the fixture. As such, the collection fuses Delta Light's credo for design sophistication and eye for detail, with precise engineering and premium materials, resulting in minimal fixtures with maximum impact. The interchangeable covers and colour finishes allow you to apply luminaires that disappear into the background.



CLEAN
SIGHTLINES
MINIMAL
APPEARANCE
MAXIMUM EYE
COMFORT
GLARE-FREE
ONE LUMINAIRE
TYPE FOR
MULTIPLE
LIGHTING
SCENOGRAPHIES



iMAX[®] SOFT CEILING

iMAX[®]

Uniform light to create general, glare-free illumination for all areas of application. A discrete appearance is combined with a vast multitude of variations, including different beams, outputs, CRI and colour finishes. A timeless, highly functional and inconspicuous architectural lighting solution.

iMAX[®] ADJUSTABLE

A versatile accent lighting solution to emphasize individual objects or architectural elements. The tilt mechanism allows the luminaire to be angled up to 30°, engineered with precision for optimum beam alignment. As a result, the light is emitted exactly where you want it. The tilting indicator and double locking system enable precise alignment of multiple fixtures.

Multitude of Options

The **iMAX[®]** collection features a wide range of minimal recessed lighting fixtures, combining a discrete presence with high quality results. You can choose from **fixed or adjustable, trimless or with trim, and a wallwash version**, each one available with different light sources and finishes.

While the wallwasher comes in LED only, the other three versions can be applied with either LED, halogen or discharge lamps. Opting for LED opens a wide array of possibilities. 400, 800, 1300 or 2000 lumens.

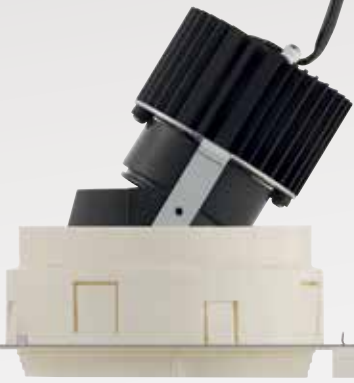

iMAX® ADJUSTABLE TRIMLESS

Ultimate minimalism combined with maximum eye comfort. This version comes with a trimless mounting kit enabling quick and precise installation and finishing. The interchangeable black, white or gold insert allows you to match the fixture with its surroundings. A super smooth finish matched with maximum lighting comfort.



iMAX® WALLWASH

Evenly illuminated walls, thanks to the high performance soft ceiling® wallwashers. The specially designed reflector enables uninterrupted, homogenous illumination of the wall, from floor to ceiling. To obtain the best result, specific attention needs to go to the recommended spacing and setback from the wall.



One cut-out for multiple versions: Fixed / Adjustable / Wallwash

iMAX[®]

OVERVIEW

REQUIREMENTS

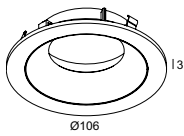
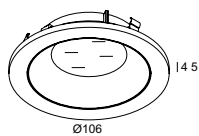
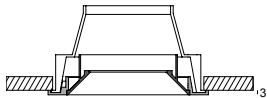
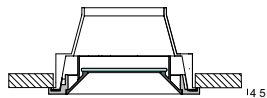
ROUND	ROUND IP (IP54)
	
	
400 00 11 ◇ ◇ = B-B / B-MMAT / W-W / W-B / W-MMAT	400 00 21 ◇ ◇ = B-B / B-MMAT / W-W / W-B / W-MMAT IP54

BASE

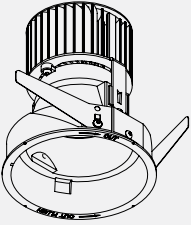
iMAX [®]	PAG 18				400 00 11 ◇		400 00 21 ◇	
			lm	W	Code	+	+	
			585lm	7W	BL4	+	+	
			920lm	10W	BR8	+	+	
			1570lm	18W	BR20	+	+	
			700lm	8W	XR13	+	+	
			297lm	4W	CL	+	+	
			Halogen		50	401 60 00	+	+
		50 HI	401 61 00	+	+			
Discharge		C50	401 80 00	+	+			

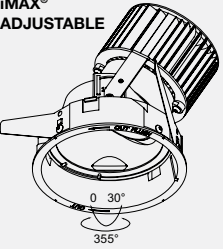

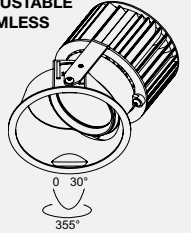
iMAX [®] ADJUSTABLE	PAG 26				400 00 11 ◇		400 00 21 ◇	
			lm	W	Code	+	+	
			585lm	7W	BL4	+	+	
			920lm	10W	BR8	+	+	
			1570lm	18W	BR20	+	+	
			700lm	8W	XR13	+	+	
			297lm	4W	CL	+	+	
			Halogen		50	402 60 00	+	+
		50 HI	402 61 00	+	+			
Discharge		C50	402 80 00	+	+			

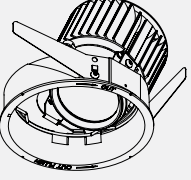
iMAX [®] ADJUSTABLE TRIMLESS	PAG 34							
			lm	W	Code			
			585lm	7W	BL4			
			920lm	10W	BR8			
			1570lm	18W	BR20			
			700lm	8W	XR13			
			297lm	4W	CL			
			Halogen		50			
		50 HI						
Discharge		C50						

iMAX [®] WALLWASH	PAG 42							
			lm	W	Code			
			920lm	10W	BR8			
			700lm	8W	XR13			

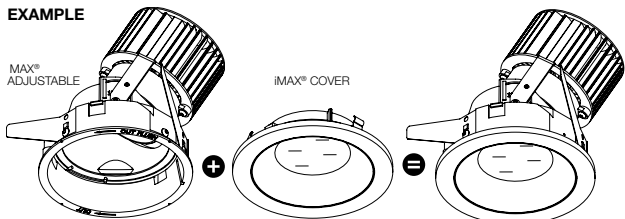
EXAMPLE

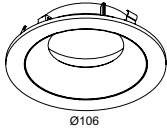
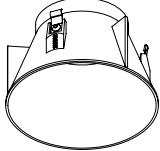
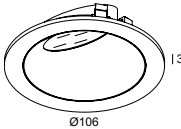
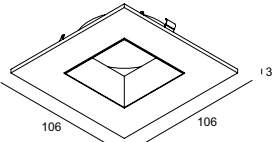
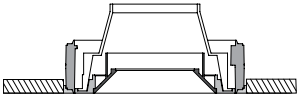
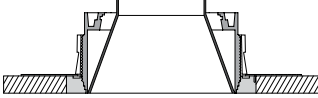

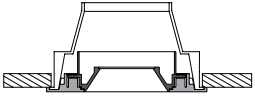
ROUND FLUSH	ROUND TRIMLESS	ROUND WALLWASH	SQUARE
 Ø106	 Ø102	 Ø106	 106
			
400 00 19 ◇ ◇ = B-B / B-MMAT / W-W / W-B / W-MMAT	400 00 30 ◇ ◇ = B / MMAT / W	400 00 41 ◇ ◇ = B-B / B-MMAT / W-W / W-B / W-MMAT INCL. 1 x SOFTENING LENS IP43	400 00 55 ◇ ◇ = B-B / B-MMAT / W-W / W-B / W-MMAT

401 02 04 ○○○ + 400 00 19 ◇			401 02 04 ○○○ + 400 00 55 ◇
401 01 08 XXX + 400 00 19 ◇			401 01 08 XXX + 400 00 55 ◇
401 01 20 XXX + 400 00 19 ◇			401 01 20 XXX + 400 00 55 ◇
401 11 13 YYY + 400 00 19 ◇			401 11 13 YYY + 400 00 55 ◇
401 22 02 *** + 400 00 19 ◇			401 22 02 *** + 400 00 55 ◇
401 60 00 + 400 00 19 ◇			401 60 00 + 400 00 55 ◇
401 61 00 + 400 00 19 ◇			401 61 00 + 400 00 55 ◇
401 80 00 + 400 00 19 ◇			401 80 00 + 400 00 55 ◇

402 02 04 ○○○ + 400 00 19 ◇			402 02 04 ○○○ + 400 00 55 ◇
402 01 08 XXX + 400 00 19 ◇			402 01 08 XXX + 400 00 55 ◇
402 01 20 XXX + 400 00 19 ◇			402 01 20 XXX + 400 00 55 ◇
402 11 13 YYY + 400 00 19 ◇			402 11 13 YYY + 400 00 55 ◇
402 22 02 *** + 400 00 19 ◇			402 22 02 *** + 400 00 55 ◇
402 60 00 + 400 00 19 ◇			402 60 00 + 400 00 55 ◇
402 61 00 + 400 00 19 ◇			402 61 00 + 400 00 55 ◇
402 80 00 + 400 00 19 ◇			402 80 00 + 400 00 55 ◇

	403 02 04 ○○○ + 400 00 30 ◇		
	403 01 08 XXX + 400 00 30 ◇		
	403 01 20 XXX + 400 00 30 ◇		
	403 11 13 YYY + 400 00 30 ◇		
	403 22 02 *** + 400 00 30 ◇		
	403 60 00 + 400 00 30 ◇		
	403 61 00 + 400 00 30 ◇		
	403 80 00 + 400 00 30 ◇		

		404 01 08 XXX + 400 00 41 ◇	
		404 11 13 YYY + 400 00 41 ◇	

CRI	>80				>90 (>95 for YYY)			
	2700		3000		2700		3000	
K								
REFLECTOR	29°	43°	29°	43°	29°	43°	29°	43°
XXX	821	822	831	832	921	922	931	932
YYY	⊘	822	⊘	832	⊘	922	⊘	932

CRI	>80				>90			
	2700		3000		2700		3000	
K								
LENS	6°	10°	6°	10°	6°	10°	6°	10°
***	829	⊘	839	⊘	929	⊘	939	⊘
○○○	⊘	829	⊘	839	⊘	929	⊘	939

iMAX[®] COVERS

Round

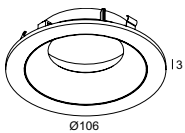

iMAX[®] COVER ROUND ◇
400 00 11 ◇
 ◇ = B-B / B-MMAT / W-W / W-B / W-MMAT
FOR iMAX[®] & iMAX[®] ADJUSTABLE

0,1

Round IP

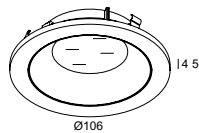

iMAX[®] COVER ROUND IP ◇
400 00 21 ◇
 ◇ = B-B / B-MMAT / W-W / W-B / W-MMAT
FOR iMAX[®] & iMAX[®] ADJUSTABLE

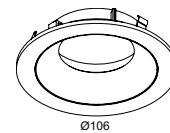

0,1  IP20
 IP54

Round Flush



iMAX[®] COVER ROUND FLUSH ◇
400 00 19 ◇
 ◇ = B-B / B-MMAT / W-W / W-B / W-MMAT
FOR iMAX[®] & iMAX[®] ADJUSTABLE

0,1

REQUIREMENTS
MOUNTING KIT FLUSH
400 90 01
 121  12

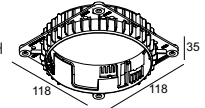

iMAX[®] + iMAX[®] COVER ROUND W-MMAT



iMAX[®] + iMAX[®] COVER ROUND IP W-B



iMAX[®] + iMAX[®] COVER ROUND FLUSH B-B



iMAX[®] ADJUSTABLE + iMAX[®] COVER ROUND B-MMAT



iMAX[®] ADJUSTABLE + iMAX[®] COVER ROUND IP W-W



iMAX[®] ADJUSTABLE + iMAX[®] COVER ROUND FLUSH B-MMAT

Round Trimless

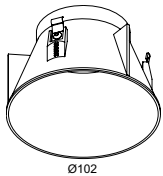
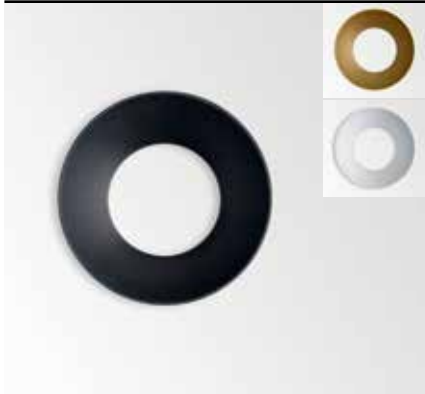

iMAX® COVER ROUND TRIMLESS ◇
400 00 30 ◇
 ◇ = B / MMAT / W
FOR iMAX® ADJUSTABLE TRIMLESS

0,1

Round Wallwash

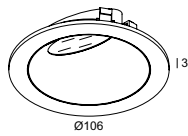

iMAX® COVER ROUND WALLWASH ◇
400 00 41 ◇
 ◇ = B-B / B-MMAT / W-W / W-B / W-MMAT
 INCL. 1 x SOFTENING LENS
FOR iMAX® WALLWASH

0,1

Square

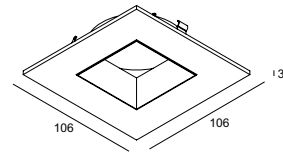
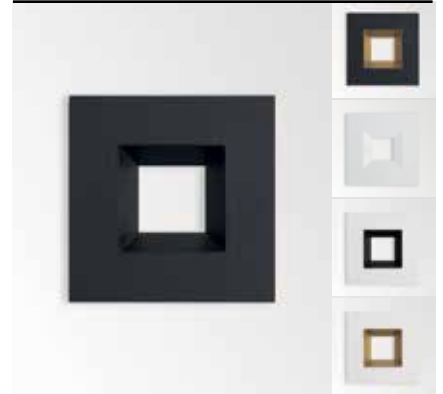

iMAX® COVER SQUARE ◇
400 00 55 ◇
 ◇ = B-B / B-MMAT / W-W / W-B / W-MMAT
FOR iMAX® & iMAX® ADJUSTABLE

0,1



MAX® ADJUSTABLE TRIMLESS + iMAX® COVER ROUND TRIMLESS W



MAX® WALLWASH + iMAX® COVER ROUND WALLWASH B-B



iMAX® + iMAX® COVER SQUARE W-B



iMAX® ADJUSTABLE + MAX® COVER SQUARE B-MMAT

iMAX[®] ACCESSORIES

Only for
3.led

Accessories for
iMAX[®]

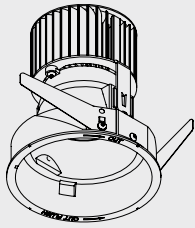

iMAX[®]
ADJUSTABLE

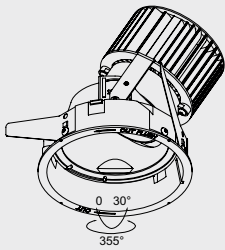

iMAX[®]
ADJUSTABLE
TRIMLESS

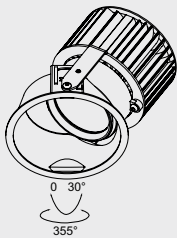

iMax[®] Honeycomb



iMAX[®] HONEYCOMB ◊
400 03 01 ◊
◊ = B

0,1



COMBINATION OF MAX. 2 ACCESSORIES

iMax[®] Linear Spread Lens



iMAX[®] LINEAR SPREAD LENS
400 03 02

0,1

BEAM / NO FILTER

BEAM / HONEYCOMB

BEAM / LINEAR SPREAD LENS

iMax® Spread Lens

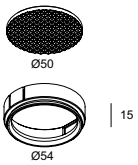

iMAX® SPREAD LENS
400 03 03

0,1

iMax® Softening Lens

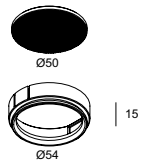

iMAX® SOFTENING LENS
400 03 04

0,1

iMax® Glass SBL

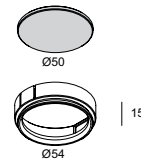

iMAX® GLASS SBL
400 03 05

0,1

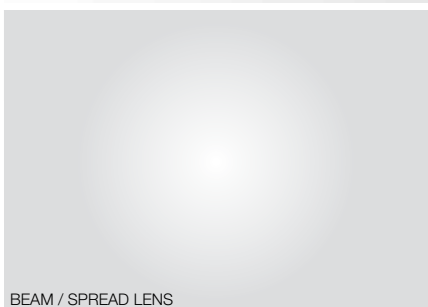

BEAM / SPREAD LENS



BEAM / SOFTENING LENS



BEAM / GLASS SBL

iMAX®

Optimal cooling for 400, 800, 1300 or 2000Lm, respecting minimal recessed depth.

Using advanced led engines, delivering high performance, maximum efficacy and high quality illumination. Available in different colour temperatures, CRI and output levels. Color Consistency 2SDCM / 3SDCM

Wide range of lenses and reflectors available, guaranteeing uniform illumination in extreme narrow, narrow, medium and wide beams.

Solutions for solid material or void ceiling constructions.

Range of light shaping accessories available, combining maximum eye comfort, full beam control and minimal light loss. Up to 2 accessories can be combined in 1 fixture.

Interchangeable round or square front cover, available in white, black and gold combinations. These covers are characterized by a slender trim, or can be installed flush to the ceiling for a super smooth finish, fading into its surroundings.



LED

Product Reference401

LED

- 01 08 Bridgelux Reflector 800
- 01 20 Bridgelux Reflector 2000
- 02 04 Bridgelux Lens 400
- 11 13 Xicato Reflector 1300
- 22 02 Cree Lens

CRI

- 8 CRI>80
- 9 CRI>90 (Xicato CRI>95)

Colour Temperature

- 2 2700K ●
- 3 3000K ●
- 4 4000K ● (on request)

Beam Angle

- 9 Spot (only for Lens-types)
- 1 Flood (only for Reflector-types / except Xicato)
- 2 Wide Flood (only for Reflector-types)



Requirement Reference400 00 ◊

Cover

- 11 Round
- 19 Round Flush
- 21 Round IP
- 55 Square

Colour

- B-B Black-Black
- B-MMAT Black-Gold Mat
- W-B White-Black
- W-MMAT White-Gold Mat
- W-W White-White

Halogen / Discharge

Product Reference

- 401 60 00 Halogen (12V)
- 401 61 00 Halogen GU10 (Mains Voltage)
- 401 80 00 Discharge



FULL INFO / PAG 14

Requirements

IMAX® COVER ROUND ◇

400 00 11 ◇

◇ = B-B / B-MMAT / W-W / W-B / W-MMAT
IP20



IMAX® COVER ROUND IP ◇

400 00 21 ◇

◇ = B-B / B-MMAT / W-W / W-B / W-MMAT
IP54



MOUNTING KIT FLUSH

400 90 01

121 12



IMAX® COVER ROUND FLUSH ◇

400 00 19 ◇

◇ = B-B / B-MMAT / W-W / W-B / W-MMAT
IP20



IMAX® COVER SQUARE ◇

400 00 55 ◇

◇ = B-B / B-MMAT / W-W / W-B / W-MMAT
IP20



FULL INFO / PAG TEC

Options

INSTALLATION

MOUNTING SET S2
400 99 00



CONTROL GEAR



LED POWER SUPPLY

350mA-DC / 15W

300 90 91

115 x 34 x 19

LED POWER SUPPLY

350mA-DC / 16W Dim8

300 90 3112

76 x 34 x 24

350mA-DC / 17W

3

1 8 2

LED POWER SUPPLY

350mA-DC / 18W

300 90 112

81 x 35 x 23

LED POWER CONVERTER

24V-DC → MULTI CURRENT / 48W DIM9

300 90 67

90 x 53 x 58

LED POWER SUPPLY

50 20

300 90 92

111 x 38 x 28

LED POWER SUPPLY

500mA-DC / 32W Dim8

300 90 5120

86 x 56 x 24

LED POWER SUPPLY

700mA-DC / 12W

300 90 43

81 x 40 x 23

LED POWER SUPPLY

7 20

300 90 93

111 x 38 x 28

LED POWER SUPPLY

700mA-DC / 36W Dim8

300 90 123

133 x 40 x 30

700mA-DC / 32W Dim8

7 20

8 x 56 x 24

LED POWER SUPPLY

MULTI-POWER Dim1

300 90 64

103 x 67 x 21

MULTI-POWER

9 4

124,5 x 79 x 22

1

6

65 4 35

0

7

03 67 1

LED POWER SUPPLY

MULTI-POWER Dim9

300 90 63

111 x 79 x 22

FULL INFO / PAG 16

Accessories

IMAX® HONEYCOMB ◇

400 03 01 ◇

◇ = B

IMAX® LINEAR SPREAD LENS

400 03 02

IMAX® SPREAD LENS

400 03 03

IMAX® SOFTENING LENS

400 03 04

IMAX® GLASS SBL

400 03 05

IMAX® TUBE ◇

400 03 10 ◇

◇ = C / M

NOT IN COMBINATION WITH
HONEYCOMB / LENS / GLASS SBL



IMAX® BR 8 + IMAX® COVER ROUND W-B + IMAX® TUBE M

4000K ●

3000K ●

LENS SP-10°

REFLECTOR FL-29°

REFLECTOR WFL-43°

2700K ●

LENS SP-10°

REFLECTOR FL-29°

REFLECTOR WFL-43°



IMAX® BR 8 + MOUNTING SET S2

DIM1: dimming by 1-10V

DIM6: dimming by push button / falling edge dimmer

DIM7: dimming by push button / 1-10V

DIM8: dimming by falling edge dimmer

DIM9: dimming by push button / 1-10V / Dali

Δ DELTALIGHT



iMax® BR

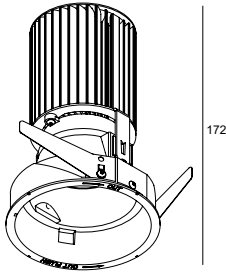
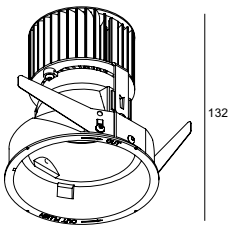

iMax® BL

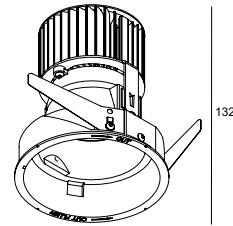

98 x 145 max.25

98 x 185 max.25

98 x 145 max.25

CRI > 80		CRI > 90	
ON REQUEST		ON REQUEST	
660 lm (7W) 920 lm (10W)	580 lm (7W) 810 lm (10W)	1570 lm	1295 lm
iMAX® BR8 83029 401 01 08 831	iMAX® BR8 93029 401 01 08 931	iMAX® BR20 83029 401 01 20 831	iMAX® BR20 93029 401 01 20 931
iMAX® BR8 83043 401 01 08 832	iMAX® BR8 93043 401 01 08 932	iMAX® BR20 83043 401 01 20 832	iMAX® BR20 93043 401 01 20 932
620 lm (7W) 865 lm (10W)	525 lm (7W) 735 lm (10W)	1475 lm	1284 lm
iMAX® BR8 82729 401 01 08 821	iMAX® BR8 92729 401 01 08 921	iMAX® BR20 82729 401 01 20 821	iMAX® BR20 92729 401 01 20 921
iMAX® BR8 82743 401 01 08 822	iMAX® BR8 92743 401 01 08 922	iMAX® BR20 82743 401 01 20 822	iMAX® BR20 92743 401 01 20 922

CRI > 80		CRI > 90	
ON REQUEST		ON REQUEST	
585 lm	485 lm		
iMAX® BL4 83010 401 02 04 839	iMAX® BL4 93010 401 02 04 939		
565 lm	455 lm		
iMAX® BL4 82710 401 02 04 829	iMAX® BL4 92710 401 02 04 929		

FIXED
INCL.1 x POWERLED WHITE 7-10W BRIDGELUX
EXCL.LED POWER SUPPLY 350-500mA-DC



REQUIREMENTS
iMAX® COVER
MOUNTING KIT FLUSH (ONLY FOR COVER ROUND FLUSH)

OPTIONS
MOUNTING SET S2
LED POWER SUPPLY 350-500mA-DC / DIM

ACCESSORIES
iMAX® ACCESSORIES

FIXED
INCL.1 x POWERLED WHITE 18W BRIDGELUX
EXCL.LED POWER SUPPLY 500mA-DC



REQUIREMENTS
iMAX® COVER
MOUNTING KIT FLUSH (ONLY FOR COVER ROUND FLUSH)

OPTIONS
MOUNTING SET S2
LED POWER SUPPLY 500mA-DC / DIM

ACCESSORIES
iMAX® ACCESSORIES

FIXED
INCL.1 x POWERLED WHITE 7W BRIDGELUX
EXCL.LED POWER SUPPLY 700mA-DC

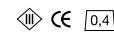

REQUIREMENTS
iMAX® COVER
MOUNTING KIT FLUSH (ONLY FOR COVER ROUND FLUSH)

OPTIONS
MOUNTING SET S2
LED POWER SUPPLY 700mA-DC / DIM

ACCESSORIES
iMAX® ACCESSORIES



iMAX® XR13 + iMAX® COVER ROUND W-B

FULL INFO / PAG 14

Requirements

iMAX® COVER ROUND ◊

400 00 11 ◊

◊ = B-B / B-MMAT / W-W / W-B / W-MMAT
IP20



iMAX® COVER ROUND IP ◊

400 00 21 ◊

◊ = B-B / B-MMAT / W-W / W-B / W-MMAT
IP54



MOUNTING KIT FLUSH

400 90 01

⦿ 121 ⚙ 12



iMAX® COVER ROUND FLUSH ◊

400 00 19 ◊

◊ = B-B / B-MMAT / W-W / W-B / W-MMAT
IP20



iMAX® COVER SQUARE ◊

400 00 55 ◊

◊ = B-B / B-MMAT / W-W / W-B / W-MMAT
IP20



FULL INFO / PAG TEC

Options

INSTALLATION

MOUNTING SET S2

400 99 00



CONTROL GEAR

LED POWER CONVERTER 90 x 53 x 58
24V-DC → MULTI CURRENT / 48W DIM9
300 90 67



LED POWER SUPPLY 500mA-DC / 20W 111 x 38 x 28
300 90 92

LED POWER SUPPLY 500mA-DC / 32W Dim8 86 x 56 x 24
300 90 5120

LED POWER SUPPLY 700mA-DC / 12W 81 x 40 x 23
300 90 43

L	m	D	PPL	
7			17W	3
3		0	93	

LED POWER SUPPLY 700mA-DC / 36W Dim8 133 x 40 x 30
300 90 123

	R	Y	
700mA-DC / 40W Dim8			86 x 56 x 24
0 9	7	1	20

	ER	Y	
-		Dim1	103 x 67 x 21
64			

LED POWER SUPPLY MULTI-POWER 124,5 x 79 x 22
300 90 914

LED POWER SUPPLY MULTI-POWER Dim6 165 x 47 x 35
300 90 61

LED POWER SUPPLY MULTI-POWER Dim7 103 x 67 x 21
300 90 60

LED POWER SUPPLY MULTI-POWER Dim9 111 x 79 x 22
300 90 63

FULL INFO / PAG 16

Accessories

iMAX® HONEYCOMB ◊

400 03 01 ◊

◊ = B

iMAX® LINEAR SPREAD LENS

400 03 02

iMAX® SPREAD LENS

400 03 03

iMAX® SOFTENING LENS

400 03 04

iMAX® GLASS SBL

400 03 05

iMAX® TUBE ◊

400 03 10 ◊

◊ = C / M

NOT IN COMBINATION WITH
HONEYCOMB / LENS / GLASS SBL

DIM1: dimming by 1-10V

DIM6: dimming by push button / falling edge dimmer

DIM7: dimming by push button / 1-10V

DIM8: dimming by falling edge dimmer

DIM9: dimming by push button / 1-10V / Dali

led iMax® XR

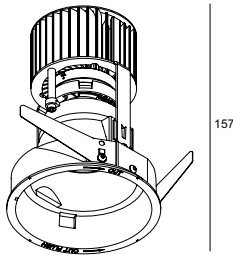

led iMax® CL

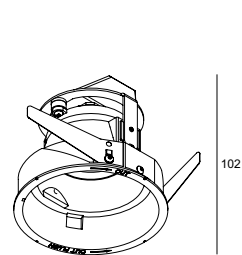
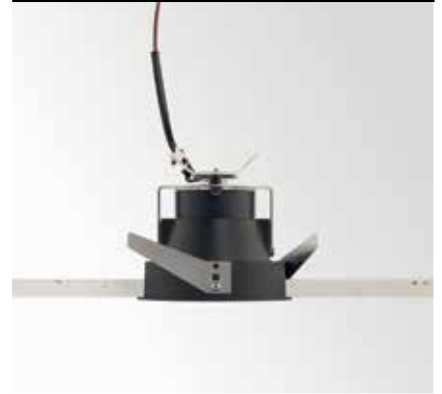

98 x 170 max.25

	CRI > 80	CRI > 95
4000K	ON REQUEST	
3000K	700 lm	700 lm
LENS SP-6°		
REFLECTOR WFL-43°	iMAX® XR13 83043 401 11 13 832	iMAX® XR13 93043 401 11 13 932
2700K	700 lm	700 lm
LENS SP-6°		
REFLECTOR WFL-43°	iMAX® XR13 82743 401 11 13 822	iMAX® XR13 92743 401 11 13 922

FIXED
INCL.1 x POWERLED WHITE 8W XICATO
EXCL.LED POWER SUPPLY 500mA-DC



REQUIREMENTS
iMAX® COVER
MOUNTING KIT FLUSH (ONLY FOR COVER ROUND FLUSH)

OPTIONS
MOUNTING SET S2
LED POWER SUPPLY 500mA-DC / DIM

ACCESSORIES
iMAX® ACCESSORIES

98 x 115 max.25

	CRI > 80	CRI > 90
	ON REQUEST	
	223 lm (3W) 297 lm (4W)	200 lm (3W) 267 lm (4W)
	iMAX® CL 83006 401 22 02 839	iMAX® CL 93006 401 22 02 939
	208 lm (3W) 277 lm (4W)	187 lm (3W) 249 lm (4W)
	iMAX® CL 82706 401 22 02 829	iMAX® CL 92706 401 22 02 929

FIXED
INCL.1 x POWERLED WHITE 3-4W CREE
EXCL.LED POWER SUPPLY 700-1050mA-DC

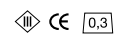

REQUIREMENTS
iMAX® COVER
MOUNTING KIT FLUSH (ONLY FOR COVER ROUND FLUSH)

OPTIONS
MOUNTING SET S2
LED POWER SUPPLY 700-1050mA-DC / DIM

ACCESSORIES
iMAX® ACCESSORIES

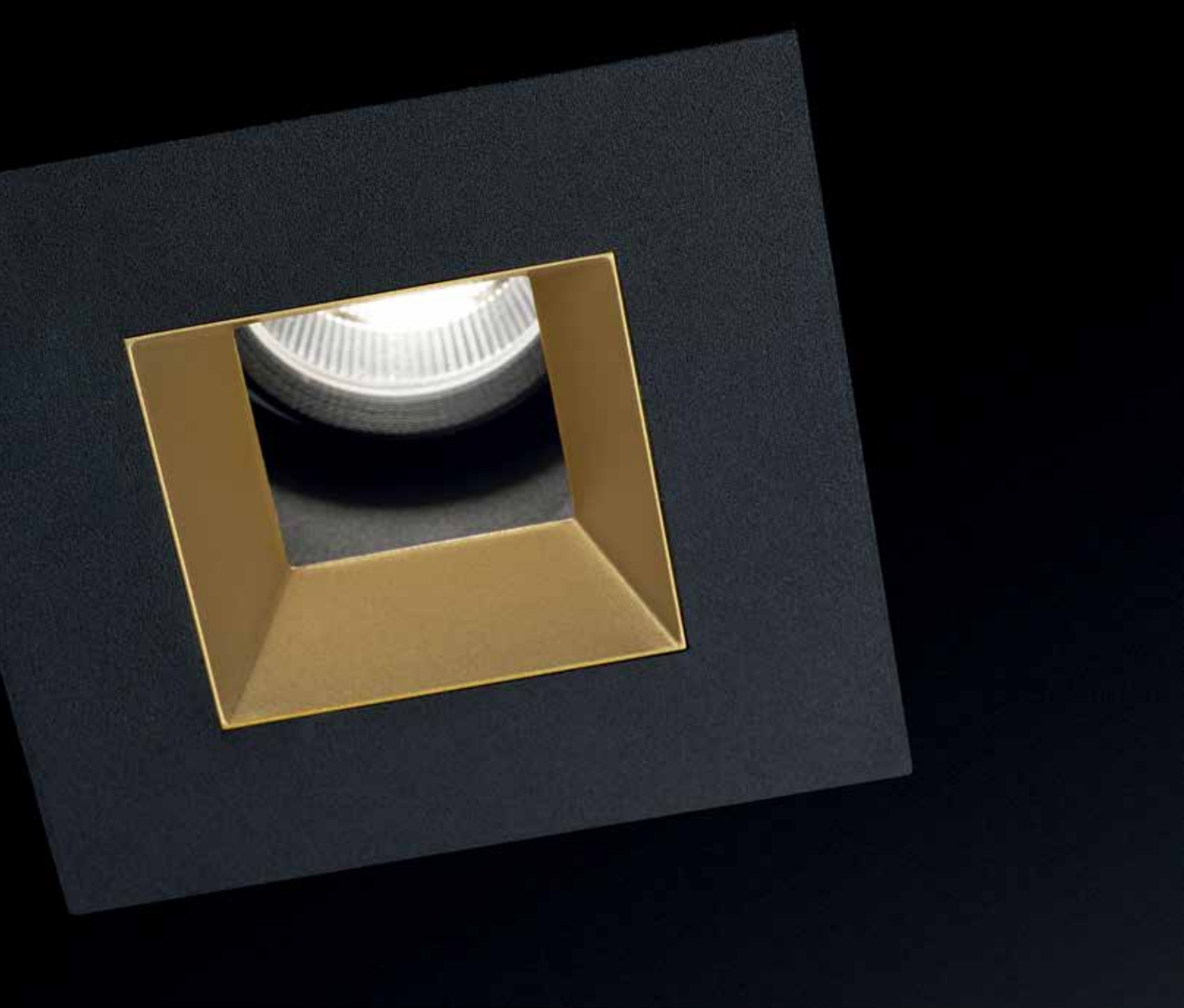

FULL INFO / PAG 14

Requirements

iMAX® COVER ROUND ◊

400 00 11 ◊

◊ = B-B / B-MMAT / W-W / W-B / W-MMAT
IP20



iMAX® COVER ROUND IP ◊

400 00 21 ◊

◊ = B-B / B-MMAT / W-W / W-B / W-MMAT
IP54



MOUNTING KIT FLUSH

400 90 01

121 12



iMAX® COVER ROUND FLUSH ◊

400 00 19 ◊

◊ = B-B / B-MMAT / W-W / W-B / W-MMAT
IP20



iMAX® COVER SQUARE ◊

400 00 55 ◊

◊ = B-B / B-MMAT / W-W / W-B / W-MMAT
IP20



FULL INFO / PAG TEC

Options

CONTROL GEAR



TRANSFO 50W

200 46 06

86 x 31 x 20

TRANSFO 100W

200 46 10

107 x 35 x 21

BALLASTSET C50 20 4,0 kV

200 44 21

140 x 67 x 31

BALLASTSET C50 35 4,0 kV

200 44 36

140 x 67 x 31

INSTALLATION

MOUNTING SET S2

400 99 00



FULL INFO / PAG TEC

Accessories

CLIP 50 ◊

201 30 98 ◊

◊ = A / B / W

Ø50 / H12



DICROIC FILTER 50

201 30 11

201 30 12

201 30 13

201 30 14

Ø50
max. 20W



iMax® 50

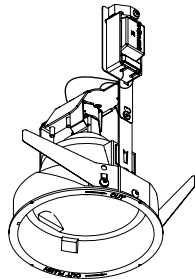

166

98 x 150 max.25

iMAX® 50

401 60 00

FIXED

GX5.3 / 12V / EXCL.TRANSFO

1 x QR-C51 max.50W

1 x QR-C51 max.35W (COVER IP)

CE 0.2 0.5

REQUIREMENTS

iMAX® COVER

MOUNTING KIT FLUSH (ONLY FOR COVER ROUND FLUSH)

OPTIONS

TRANSFO

MOUNTING SET S2

LED SOLUTION - PAG TEC 13

ACCESSORIES (max. 35W)

CLIP 50 + DICROIC FILTER 50

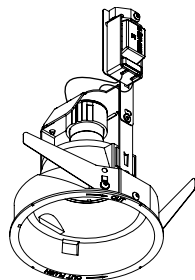

166

98 x 150 max.25

iMAX® 50Hi

401 61 00

FIXED

GU10 / 100-240V / 50-60Hz

1 x QPAR51 max.35W

1 x QPAR51 max.20W (COVER IP)

CE 0.2 0.5

REQUIREMENTS

iMAX® COVER

MOUNTING KIT FLUSH (ONLY FOR COVER ROUND FLUSH)

OPTIONS

MOUNTING SET S2

LED SOLUTION - PAG TEC 13



iMax® C50

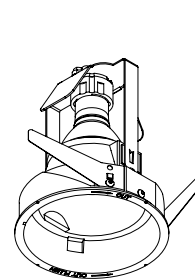
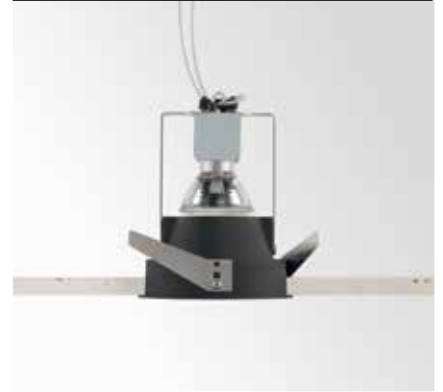

143

98 x 150 max.25

iMAX® C50

401 80 00

FIXED

GX10 / EXCL.EVG

1 x HIPAR51 max.35W

CE 0.2 0.5

REQUIREMENTS

iMAX® COVER

MOUNTING KIT FLUSH (ONLY FOR COVER ROUND FLUSH)

OPTIONS

BALLASTSET C50

MOUNTING SET S2

iMAX[®]

ADJUSTABLE



Optimal cooling for 400, 800, 1300 or 2000Lm, respecting minimal recessed depth.

Using advanced led engines, delivering high performance, maximum efficacy and high quality illumination. Available in different colour temperatures, CRI and output levels. Color Consistency 2SDCM / 3SDCM

Wide range of lenses and reflectors available, guaranteeing uniform illumination in extreme narrow, narrow, medium and wide beams.

Double locking system enables fixation of both tilting and fixture position, for perfect alignment of multiple fixtures.

Range of light shaping accessories available, combining maximum eye comfort, full beam control and minimal light loss. Up to 2 accessories can be combined in 1 fixture.

Fixed and adjustable versions available with clear glass IP54

Interchangeable round or square front cover, available in white, black and gold combinations. These covers are characterized by a slender trim, or can be installed flush to the ceiling for a super smooth finish, fading into its surroundings.

LED

Product Reference402

LED

01 08 Bridgelux Reflector 800
01 20 Bridgelux Reflector 2000
02 04 Bridgelux Lens 400
11 13 Xicato Reflector 1300
22 02 Cree Lens

CRI

8 CRI>80
9 CRI>90 (Xicato CRI>95)

Colour Temperature

2 2700K ●
3 3000K ●
4 4000K ● (on request)

Beam Angle

9 Spot (only for Lens-types)
1 Flood (only for Reflector-types / except Xicato)
2 Wide Flood (only for Reflector-types)



Requirement Reference400 00 ◇

Cover

11 Round
19 Round Flush
21 Round IP
55 Square

Colour

B-B Black-Black
B-MMAT Black-Gold Mat
W-B White-Black
W-MMAT White-Gold Mat
W-W White-White

Halogen / Discharge

Product Reference

402 60 00 Halogen (12V)
402 61 00 Halogen GU10 (Mains Voltage)
402 80 00 Discharge



FULL INFO / PAG 14

Requirements

iMAX® COVER ROUND ◇

400 00 11 ◇

◇ = B-B / B-MMAT / W-W / W-B / W-MMAT
IP20



iMAX® COVER ROUND IP ◇

400 00 21 ◇

◇ = B-B / B-MMAT / W-W / W-B / W-MMAT
IP54



MOUNTING KIT FLUSH

400 90 01

121 12



iMAX® COVER ROUND FLUSH ◇

400 00 19 ◇

◇ = B-B / B-MMAT / W-W / W-B / W-MMAT
IP20



iMAX® COVER SQUARE ◇

400 00 55 ◇

◇ = B-B / B-MMAT / W-W / W-B / W-MMAT
IP20



FULL INFO / PAG TEC

Options

CONTROL GEAR



LED POWER SUPPLY 115 x 34 x 19
350mA-DC / 15W
300 90 91

LED POWER SUPPLY 76 x 34 x 24
350mA-DC / 16W Dim8
300 90 3112

350mA-DC / 17W
300 90 913

LED POWER SUPPLY 81 x 35 x 23
350mA-DC / 18W
1 2

LED POWER CONVERTER 90 x 53 x 58
24V-DC → MULTI CURRENT / 48W DIM9
300 90 67

LED POWER SUPPLY 111 x 38 x 28
500mA-DC / 20W
300 90 92

LED POWER SUPPLY 86 x 56 x 24
500mA-DC / 32W Dim8
300 90 5120

700mA-DC / 12W
43

LED POWER SUPPLY 111 x 38 x 28
700mA-DC / 17W
300 90 93

LED POWER SUPPLY 133 x 40 x 30
6
300 90 123

00mA-DC / 32W D m8
300 90 7120

LED POWER SUPPLY 103 x 67 x 21
MULTI-POWER Dim1
300 90 64

124,5 x 79 x 22
9 4

65 4 35
6

103 x 67 x 21
7
300 90 60

LED POWER SUPPLY 111 x 79 x 22
MULTI-POWER Dim9
300 90 63

DIM1: dimming by 1-10V
DIM6: dimming by push button / falling edge dimmer
DIM7: dimming by push button / 1-10V
DIM8: dimming by falling edge dimmer
DIM9: dimming by push button / 1-10V / Dali

FULL INFO / PAG 16

Accessories

iMAX® HONEYCOMB ◇

400 03 01 ◇

◇ = B

iMAX® LINEAR SPREAD LENS

400 03 02

iMAX® SPREAD LENS

400 03 03

iMAX® SOFTENING LENS

400 03 04

iMAX® GLASS SBL

400 03 05

4000K ●

3000K ●

LENS SP-10°

REFLECTOR FL-29°

REFLECTOR WFL-43°

2700K ●

LENS SP-10°

REFLECTOR FL-29°

REFLECTOR WFL-43°



iMax® Adjustable BR

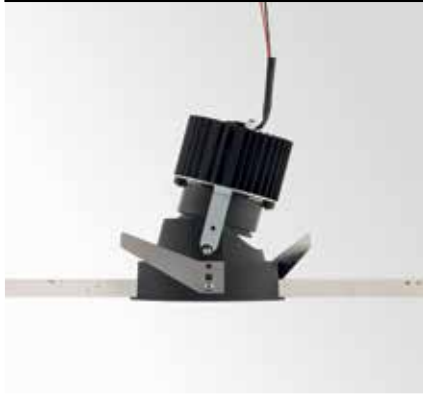

iMax® Adjustable BL

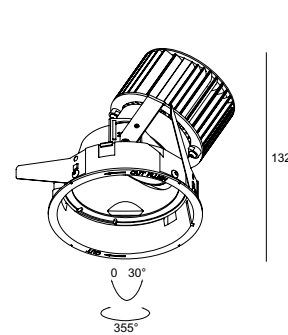
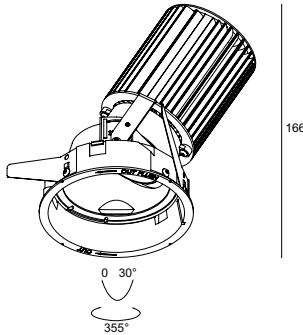
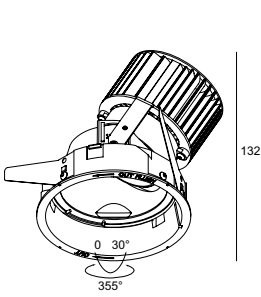
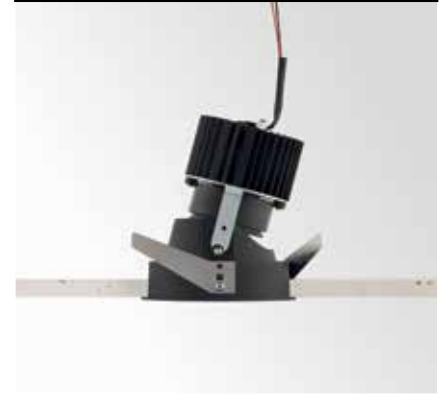

98 x 145 max.25

98 x 185 max.25

98 x 145 max.25

CRI > 80		CRI > 90	
ON REQUEST		ON REQUEST	
660 lm (7W) 920 lm (10W)	580 lm (7W) 810 lm (10W)	1570 lm	1295 lm
iMAX® ADJUSTABLE BR8 83029 402 01 08 831	iMAX® ADJUSTABLE BR8 93029 402 01 08 931	iMAX® ADJUSTABLE BR20 83029 402 01 20 831	iMAX® ADJUSTABLE BR20 93029 402 01 20 931
iMAX® ADJUSTABLE BR8 83043 402 01 08 832	iMAX® ADJUSTABLE BR8 93043 402 01 08 932	iMAX® ADJUSTABLE BR20 83043 402 01 20 832	iMAX® ADJUSTABLE BR20 93043 402 01 20 932
620 lm (7W) 865 lm (10W)	525 lm (7W) 735 lm (10W)	1475 lm	1284 lm
iMAX® ADJUSTABLE BR8 82729 402 01 08 821	iMAX® ADJUSTABLE BR8 92729 402 01 08 921	iMAX® ADJUSTABLE BR20 82729 402 01 20 821	iMAX® ADJUSTABLE BR20 92729 402 01 20 921
iMAX® ADJUSTABLE BR8 82743 402 01 08 822	iMAX® ADJUSTABLE BR8 92743 402 01 08 922	iMAX® ADJUSTABLE BR20 82743 402 01 20 822	iMAX® ADJUSTABLE BR20 92743 402 01 20 922

CRI > 80		CRI > 90	
ON REQUEST		ON REQUEST	
585 lm	485 lm		
iMAX® ADJUSTABLE BL4 83010 402 02 04 839	iMAX® ADJUSTABLE BL4 93010 402 02 04 939		
565 lm	455 lm		
iMAX® ADJUSTABLE BL4 82710 402 02 04 829	iMAX® ADJUSTABLE BL4 92710 402 02 04 929		

ADJUSTABLE 0-30° / 355°
INCL. 1 x POWERLED WHITE 7-10W BRIDGELUX
EXCL.LED POWER SUPPLY 350-500mA-DC



REQUIREMENTS
iMAX® COVER
MOUNTING KIT FLUSH (ONLY FOR COVER ROUND FLUSH)

OPTIONS
LED POWER SUPPLY 350-500mA-DC / DIM

ACCESSORIES
iMAX® ACCESSORIES

ADJUSTABLE 0-30° / 355°
INCL. 1 x POWERLED WHITE 18W BRIDGELUX
EXCL.LED POWER SUPPLY 500mA-DC



REQUIREMENTS
iMAX® COVER
MOUNTING KIT FLUSH (ONLY FOR COVER ROUND FLUSH)

OPTIONS
LED POWER SUPPLY 500mA-DC / DIM

ACCESSORIES
iMAX® ACCESSORIES

ADJUSTABLE 0-30° / 355°
INCL. 1 x POWERLED WHITE 7W BRIDGELUX
EXCL.LED POWER SUPPLY 700mA-DC

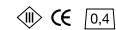

REQUIREMENTS
iMAX® COVER
MOUNTING KIT FLUSH (ONLY FOR COVER ROUND FLUSH)

OPTIONS
LED POWER SUPPLY 700mA-DC / DIM

ACCESSORIES
iMAX® ACCESSORIES



IMAX® ADJUSTABLE XR13 + IMAX® COVER ROUND W-B + MAX® SPREAD LENS

FULL INFO / PAG 14

Requirements

IMAX® COVER ROUND ◇

400 00 11 ◇

◇ = B-B / B-MMAT / W-W / W-B / W-MMAT

IP20



IMAX® COVER ROUND IP ◇

400 00 21 ◇

◇ = B-B / B-MMAT / W-W / W-B / W-MMAT

IP54



MOUNTING KIT FLUSH

400 90 01

121 12



IMAX® COVER ROUND FLUSH ◇

400 00 19 ◇

◇ = B-B / B-MMAT / W-W / W-B / W-MMAT

IP20



IMAX® COVER SQUARE ◇

400 00 55 ◇

◇ = B-B / B-MMAT / W-W / W-B / W-MMAT

IP20



FULL INFO / PAG TEC

Options

CONTROL GEAR



LED POWER CONVERTER 90 x 53 x 58

24V-DC → MULTI CURRENT / 48W DIM9

300 90 67

LED POWER SUPPLY 111 x 38 x 28

500mA-DC / 20W

300 90 92

LED POWER SUPPLY 86 x 56 x 24

500mA-DC / 32W Dim8

300 90 5120

LED POWER SUPPLY 81 x 40 x 23

700mA-DC / 12W

300 90 43

LED POWER SUPPLY 111 x 38 x 28

700mA-DC / 17W

300 90 93

LED POWER SUPPLY 133 x 40 x 30

700mA-DC / 36W Dim8

300 90 123

700mA-DC / 40W Dim8 86 x 56 x 24

7120

MULTI POWER D m1 03 x 67 x 21

64

LED POWER SUPPLY 124,5 x 79 x 22

MULTI-POWER

300 90 914

LED POWER SUPPLY 165 x 47 x 35

MULTI-POWER Dim6

300 90 61

LED POWER SUPPLY 103 x 67 x 21

MULTI-POWER Dim7

300 90 60

LED POWER SUPPLY 111 x 79 x 22

MULTI-POWER Dim9

300 90 63

FULL INFO / PAG 16

Accessories

IMAX® HONEYCOMB ◇

400 03 01 ◇

◇ = B

IMAX® LINEAR SPREAD LENS

400 03 02

IMAX® SPREAD LENS

400 03 03

IMAX® SOFTENING LENS

400 03 04

IMAX® GLASS SBL

400 03 05

DIM1: dimming by 1-10V

DIM6: dimming by push button / falling edge dimmer

DIM7: dimming by push button / 1-10V

DIM8: dimming by falling edge dimmer

DIM9: dimming by push button / 1-10V / Dali

led iMax® Adjustable XR

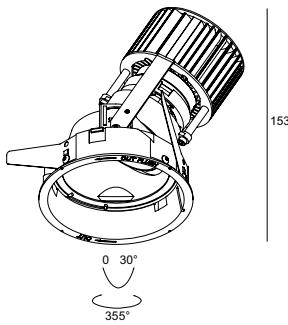
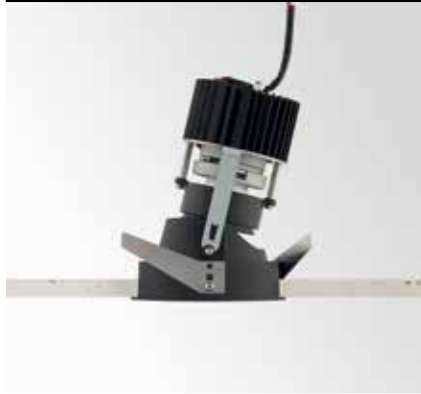

98 x 170 max.25

led iMax® Adjustable CL

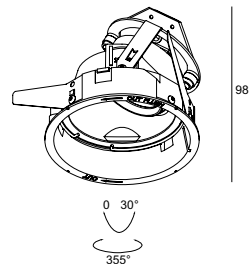
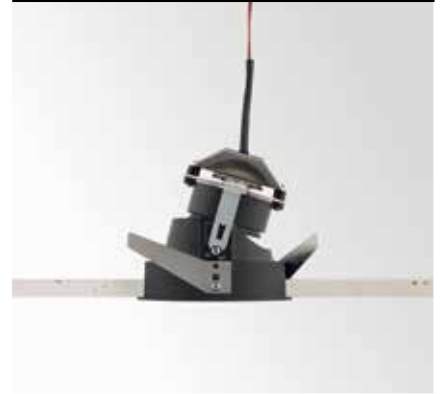

98 x 115 max.25

	CRI > 80	CRI > 95
4000K	ON REQUEST	
3000K	700 lm	700 lm
LENS SP-6°		
REFLECTOR WFL-43°	iMAX® ADJUSTABLE XR13 83043 402 11 13 832	iMAX® ADJUSTABLE XR13 93043 402 11 13 932
2700K	700 lm	700 lm
LENS SP-6°		
REFLECTOR WFL-43°	iMAX® ADJUSTABLE XR13 82743 402 11 13 822	iMAX® ADJUSTABLE XR13 92743 402 11 13 922

ADJUSTABLE 0-30° / 355°
INCL.1 x POWERLED WHITE 8W XICATO
EXCL.LED POWER SUPPLY 500mA-DC



REQUIREMENTS
iMAX® COVER
MOUNTING KIT FLUSH (ONLY FOR COVER ROUND FLUSH)

OPTIONS
LED POWER SUPPLY 500mA-DC / DIM

ACCESSORIES
iMAX® ACCESSORIES

	CRI > 80	CRI > 90
4000K	ON REQUEST	
3000K	223 lm (3W) 297 lm (4W)	200 lm (3W) 267 lm (4W)
LENS SP-6°		
REFLECTOR WFL-43°	iMAX® ADJUSTABLE CL 83006 402 22 02 839	iMAX® ADJUSTABLE CL 93006 402 22 02 939
2700K	208 lm (3W) 277 lm (4W)	187 lm (3W) 249 lm (4W)
LENS SP-6°		
REFLECTOR WFL-43°	iMAX® ADJUSTABLE CL 82706 402 22 02 829	iMAX® ADJUSTABLE CL 92706 402 22 02 929

ADJUSTABLE 0-30° / 355°
INCL.1 x POWERLED WHITE 3-4W CREE
EXCL.LED POWER SUPPLY 700-1050mA-DC



REQUIREMENTS
iMAX® COVER
MOUNTING KIT FLUSH (ONLY FOR COVER ROUND FLUSH)

OPTIONS
LED POWER SUPPLY 700-1050mA-DC / DIM

ACCESSORIES
iMAX® ACCESSORIES



30°
ADJUSTABLE
& LOCKABLE

FULL INFO / PAG 14

Requirements

iMAX® COVER ROUND ◊

400 00 11 ◊

◊ = B-B / B-MMAT / W-W / W-B / W-MMAT
IP20



iMAX® COVER ROUND IP ◊

400 00 21 ◊

◊ = B-B / B-MMAT / W-W / W-B / W-MMAT
IP54



MOUNTING KIT FLUSH

400 90 01

121 12



iMAX® COVER ROUND FLUSH ◊

400 00 19 ◊

◊ = B-B / B-MMAT / W-W / W-B / W-MMAT
IP20



iMAX® COVER SQUARE ◊

400 00 55 ◊

◊ = B-B / B-MMAT / W-W / W-B / W-MMAT
IP20



FULL INFO / PAG TEC

Options

CONTROL GEAR



TRANSFO 50W

86 x 31 x 20

200 46 06

TRANSFO 100W

107 x 35 x 21

200 46 10

BALLASTSET C50 20 4,0 kV

140 x 67 x 31

200 44 21

BALLASTSET C50 35 4,0 kV

140 x 67 x 31

200 44 36

FULL INFO / PAG TEC

Accessories

CLIP 50 ◊

201 30 98 ◊

◊ = A / B / W

Ø50 / H12



DICROIC FILTER 50

201 30 11 ●

201 30 12 ●

201 30 13 ●

201 30 14 ●

Ø50
max. 20W



iMax® Adjustable 50

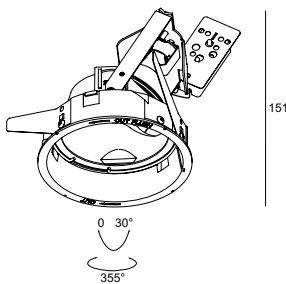

98 x 150 max.25

iMAX® ADJUSTABLE 50

402 60 00

ADJUSTABLE 0-30° / 355°

GX5.3 / 12V / EXCL.TRANSFO

1 x QR-C51 max.50W

1 x QR-C51 max.35W (COVER IP)

CE 0,2 0,5

REQUIREMENTS

iMAX® COVER

MOUNTING KIT FLUSH (ONLY FOR COVER ROUND FLUSH)

OPTIONS

TRANSFO

led LED SOLUTION - PAG TEC 13

ACCESSORIES (max. 35W)

CLIP 50 + DICROIC FILTER 50

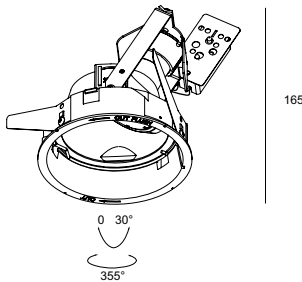

98 x 150 max.25

iMAX® ADJUSTABLE 50Hi

402 61 00

ADJUSTABLE 0-30° / 355°

GU10 / 100-240V / 50-60Hz

1 x QPAR51 max.35W

1 x QPAR51 max.20W (COVER IP)

CE 0,2 0,5

REQUIREMENTS

iMAX® COVER

MOUNTING KIT FLUSH (ONLY FOR COVER ROUND FLUSH)

OPTIONS

led LED SOLUTION - PAG TEC 13

iMax® Adjustable C50

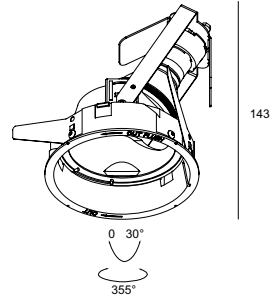
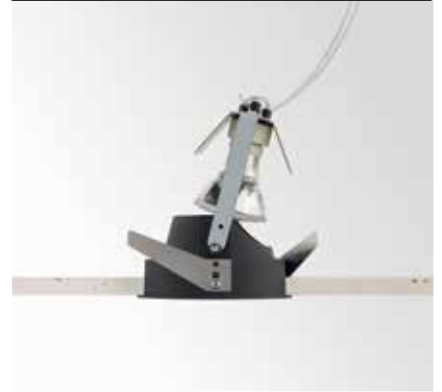

98 x 150 max.25

iMAX® ADJUSTABLE C50

402 80 00

ADJUSTABLE 0-30° / 355°

GX10 / EXCL.EVG

1 x HIPAR51 max.35W

CE 0,2 0,5

REQUIREMENTS

iMAX® COVER

MOUNTING KIT FLUSH (ONLY FOR COVER ROUND FLUSH)

OPTIONS

BALLASTSET C50

iMAX[®]

ADJUSTABLE TRIMLESS

Optimal cooling for 400, 800, 1300 or 2000Lm, respecting minimal recessed depth.

Wide range of lenses and reflectors available, guaranteeing uniform illumination in extreme narrow, narrow, medium and wide beams.

Using advanced led engines, delivering high performance, maximum efficacy and high quality illumination. Available in different colour temperatures, CRI and output levels. Color Consistency 2SDCM / 3SDCM

Range of light shaping accessories available, combining maximum eye comfort, full beam control and minimal light loss. Up to 2 accessories can be combined in 1 fixture.

Interchangeable white, black or gold inserts.

Trimless mounting kit available, enabling precise installation and perfect finishing. Easy to adjust to ceiling thickness, both for solid material or void ceiling constructions.



LED

Product Reference403

LED

- 01 08 Bridgelux Reflector 800
- 01 20 Bridgelux Reflector 2000
- 02 04 Bridgelux Lens 400
- 11 13 Xicato Reflector 1300
- 22 02 Cree Lens

CRI

- 8 CRI>80
- 9 CRI>90 (Xicato CRI>95)

Colour Temperature

- 2 2700K ●
- 3 3000K ●
- 4 4000K ● (on request)

Beam Angle

- 9 Spot (only for Lens-types)
- 1 Flood (only for Reflector-types / except Xicato)
- 2 Wide Flood (only for Reflector-types)



Requirement Reference400 00 ◇

Cover

- 30 Round Trimless

Colour

- B Black
- MMAT Gold Mat
- W White

Halogen / Discharge

Product Reference

- 403 60 00 Halogen (12V)
- 403 61 00 Halogen GU10 (Mains Voltage)
- 403 80 00 Discharge



FULL INFO / PAG 14

Requirements

MOUNTING KIT R102 TRIMLESS O.F.A.
400 91 02 OFA

133

0,4

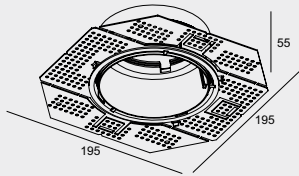

iMAX® COVER ROUND TRIMLESS ◇

400 00 30 ◇
◇ = B / MMAT / W
IP20

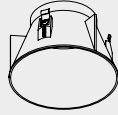

FULL INFO / PAG TEC

Options

CONTROL GEAR

LED POWER SUPPLY 115 x 34 x 19
350mA-DC / 15W
300 90 91

	6	Dim8	76 x 34 x 24
3	12		
	7		1 8 2
	3		
	8		81 x 35 x 23
1	2		

LED POWER CONVERTER 90 x 53 x 58
24V-DC → MULTI CURRENT / 48W DIM9
300 90 67

500mA-DC / 20W 111 x 38 x 28
92

LED POWER SUPPLY 86 x 56 x 24
500mA-DC / 32W Dim8
300 90 5120

LED POWER SUPPLY 81 x 40 x 23
700mA-DC / 12W
300 90 43

700mA-DC / 17W
300 90 93

LED POWER SUPPLY 133 x 40 x 30
700mA-DC / 36W Dim8
123

LED POWER SUPPLY 86 x 56 x 24
700mA-DC / 32W Dim8
300 90 7120

LED POWER SUPPLY 103 x 67 x 21
MULTI-POWER Dim1
300 90 64

LED POWER SUPPLY	124,5 x 79 x 22
9	4
	6
1	65 4 35
	7
0	03 67 1

LED POWER SUPPLY 111 x 79 x 22
MULTI-POWER Dim9
300 90 63

DIM1: dimming by 1-10V
DIM6: dimming by push button / falling edge dimmer
DIM7: dimming by push button / 1-10V
DIM8: dimming by falling edge dimmer
DIM9: dimming by push button / 1-10V / Dali

FULL INFO / PAG 16

Accessories

iMAX® HONEYCOMB ◇
400 03 01 ◇
◇ = B

iMAX® LINEAR SPREAD LENS
400 03 02

iMAX® SPREAD LENS
400 03 03

iMAX® SOFTENING LENS
400 03 04

iMAX® GLASS SBL
400 03 05

4000K ●

3000K ●

LENS SP-10°

REFLECTOR FL-29°

REFLECTOR WFL-43°

2700K ●

LENS SP-10°

REFLECTOR FL-29°

REFLECTOR WFL-43°



iMax® Adjustable Trimless BR

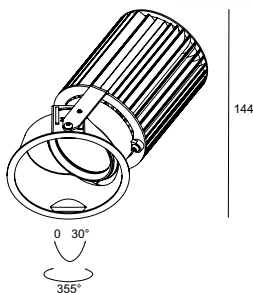
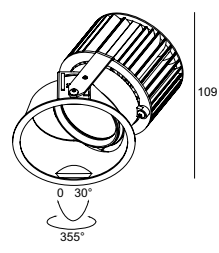
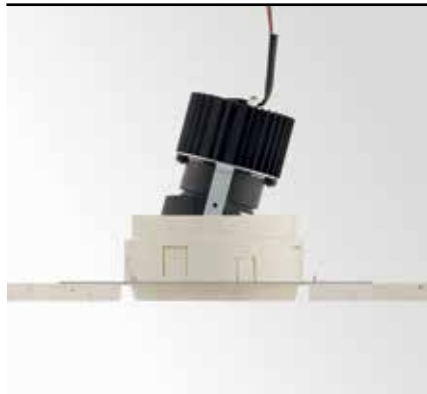

ØKIT x 145 max.25

ØKIT x 185 max.25

CRI > 80		CRI > 90	
ON REQUEST		ON REQUEST	
660 lm (7W) 920 lm (10W)	580 lm (7W) 810 lm (10W)	1570 lm	1295 lm
iMAX® ADJUSTABLE TRIMLESS BR8 83029 403 01 08 831	iMAX® ADJUSTABLE TRIMLESS BR8 93029 403 01 08 931	iMAX® ADJUSTABLE TRIMLESS BR20 83029 403 01 20 831	iMAX® ADJUSTABLE TRIMLESS BR20 93029 403 01 20 931
iMAX® ADJUSTABLE TRIMLESS BR8 83043 403 01 08 832	iMAX® ADJUSTABLE TRIMLESS BR8 93043 403 01 08 932	iMAX® ADJUSTABLE TRIMLESS BR20 83043 403 01 20 832	iMAX® ADJUSTABLE TRIMLESS BR20 93043 403 01 20 932
620 lm (7W) 865 lm (10W)	525 lm (7W) 735 lm (10W)	1475 lm	1284 lm
iMAX® ADJUSTABLE TRIMLESS BR8 82729 403 01 08 821	iMAX® ADJUSTABLE TRIMLESS BR8 92729 403 01 08 921	iMAX® ADJUSTABLE TRIMLESS BR20 82729 403 01 20 821	iMAX® ADJUSTABLE TRIMLESS BR20 92729 403 01 20 921
iMAX® ADJUSTABLE TRIMLESS BR8 82743 403 01 08 822	iMAX® ADJUSTABLE TRIMLESS BR8 92743 403 01 08 922	iMAX® ADJUSTABLE TRIMLESS BR20 82743 403 01 20 822	iMAX® ADJUSTABLE TRIMLESS BR20 92743 403 01 20 922

ADJUSTABLE 0-30° / 355°
INCL.1 x POWERLED WHITE 7-10W BRIDGELUX
EXCL.LED POWER SUPPLY 350-500mA-DC



REQUIREMENTS
MOUNTING KIT R102 TRIMLESS O.F.A.
iMAX® COVER

OPTIONS
LED POWER SUPPLY 350-500mA-DC / DIM

ACCESSORIES
iMAX® ACCESSORIES

ADJUSTABLE 0-30° / 355°
INCL.1 x POWERLED WHITE 18W BRIDGELUX
EXCL.LED POWER SUPPLY 500mA-DC



REQUIREMENTS
MOUNTING KIT R102 TRIMLESS O.F.A.
iMAX® COVER

OPTIONS
LED POWER SUPPLY 500mA-DC / DIM

ACCESSORIES
iMAX® ACCESSORIES



iMax® Adjustable Trimless BL

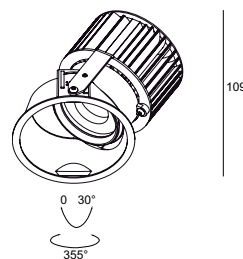
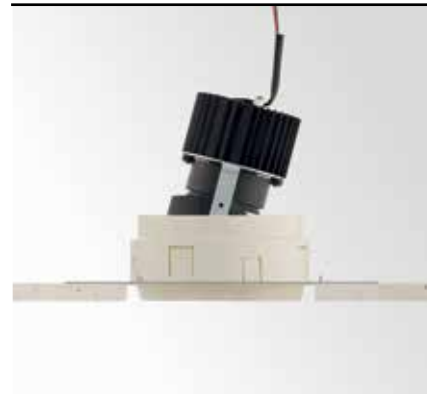

ØKIT x 145 max.25

CRI > 80		CRI > 90	
ON REQUEST		ON REQUEST	
585 lm	485 lm		
iMAX® ADJUSTABLE TRIMLESS BL4 83010 403 02 04 839	iMAX® ADJUSTABLE TRIMLESS BL4 93010 403 02 04 939		
565 lm	455 lm		
iMAX® ADJUSTABLE TRIMLESS BL4 82710 403 02 04 829	iMAX® ADJUSTABLE TRIMLESS BL4 92710 403 02 04 929		

ADJUSTABLE 0-30° / 355°
INCL.1 x POWERLED WHITE 7W BRIDGELUX
EXCL.LED POWER SUPPLY 700mA-DC



REQUIREMENTS
MOUNTING KIT R102 TRIMLESS O.F.A.
iMAX® COVER

OPTIONS
LED POWER SUPPLY 700mA-DC / DIM

ACCESSORIES
iMAX® ACCESSORIES



IMAX® ADJUSTABLE TRIMLESS XR13 + IMAX® COVER ROUND TRIMLESS MMAT

FULL INFO / PAG 14

Requirements

MOUNTING KIT R102 TRIMLESS O.F.A.
400 91 02 OFA

133

0,4

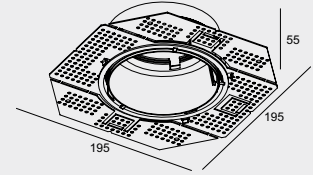

IMAX® COVER ROUND TRIMLESS ◇
400 00 30 ◇
◇ = B / MMAT / W
IP20

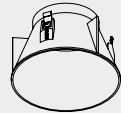

FULL INFO / PAG TEC

Options

CONTROL GEAR



LED POWER CONVERTER 90 x 53 x 58
24V-DC → MULTI CURRENT / 48W DIM9
300 90 67

LED POWER SUPPLY 111 x 38 x 28
500mA-DC / 20W
300 90 92

LED POWER SUPPLY 86 x 56 x 24
500mA-DC / 32W Dim8
300 90 5120

LED POWER SUPPLY 81 x 40 x 23
700mA-DC / 12W
300 90 43

LED POWER SUPPLY 111 x 38 x 28
700mA-DC / 17W
300 90 93

LED POWER SUPPLY 133 x 40 x 30
700mA-DC / 36W Dim8
300 90 123

0 9 7120 R 40 Y i 86 x 56 x 24

0 9 64 - ER Y Dim1 103 x 67 x 21

LED POWER SUPPLY 124,5 x 79 x 22
MULTI-POWER
300 90 914

LED POWER SUPPLY 165 x 47 x 35
MULTI-POWER Dim6
300 90 61

LED POWER SUPPLY 103 x 67 x 21
MULTI-POWER Dim7
300 90 60

LED POWER SUPPLY 111 x 79 x 22
MULTI-POWER Dim9
300 90 63

FULL INFO / PAG 16

Accessories

IMAX® HONEYCOMB ◇
400 03 01 ◇
◇ = B

IMAX® LINEAR SPREAD LENS
400 03 02

IMAX® SPREAD LENS
400 03 03

IMAX® SOFTENING LENS
400 03 04

IMAX® GLASS SBL
400 03 05

DIM1: dimming by 1-10V

DIM6: dimming by push button / falling edge dimmer

DIM7: dimming by push button / 1-10V

DIM8: dimming by falling edge dimmer

DIM9: dimming by push button / 1-10V / Dali



iMax® Adjustable Trimless XR

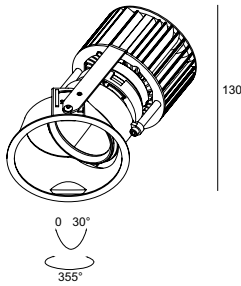
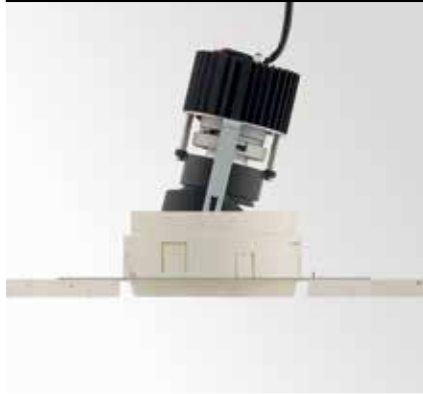

ØKIT x 170 max.25



iMax® Adjustable Trimless CL

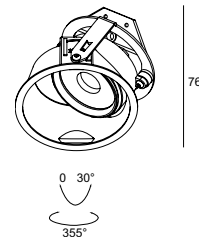
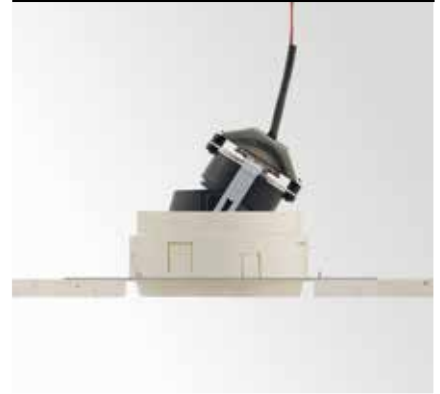

ØKIT x 115 max.25

	CRI > 80	CRI > 95
4000K		
	ON REQUEST	
3000K	700 lm	700 lm
LENS SP-6°		
REFLECTOR WFL-43°	iMAX® ADJUSTABLE TRIMLESS XR13 83043 403 11 13 832	iMAX® ADJUSTABLE TRIMLESS XR13 93043 403 11 13 932
2700K	700 lm	700 lm
LENS SP-6°		
REFLECTOR WFL-43°	iMAX® ADJUSTABLE TRIMLESS XR13 82743 403 11 13 822	iMAX® ADJUSTABLE TRIMLESS XR13 92743 403 11 13 922

ADJUSTABLE 0-30° / 355°
INCL. 1 x POWERLED WHITE 8W XICATO
EXCL. LED POWER SUPPLY 500mA-DC



REQUIREMENTS
MOUNTING KIT R102 TRIMLESS O.F.A.
iMAX® COVER

OPTIONS
LED POWER SUPPLY 500mA-DC / DIM

ACCESSORIES
iMAX® ACCESSORIES

	CRI > 80	CRI > 90
4000K		
	ON REQUEST	
3000K	223 lm (3W) 297 lm (4W)	200 lm (3W) 267 lm (4W)
LENS SP-6°		
REFLECTOR WFL-43°	iMAX® ADJUSTABLE TRIMLESS CL 83006 403 22 02 839	iMAX® ADJUSTABLE TRIMLESS CL 93006 403 22 02 939
2700K	208 lm (3W) 277 lm (4W)	187 lm (3W) 249 lm (4W)
LENS SP-6°		
REFLECTOR WFL-43°	iMAX® ADJUSTABLE TRIMLESS CL 82706 403 22 02 829	iMAX® ADJUSTABLE TRIMLESS CL 92706 403 22 02 929

ADJUSTABLE 0-30° / 355°
INCL. 1 x POWERLED WHITE 3-4W CREE
EXCL. LED POWER SUPPLY 700-1050mA-DC

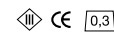

REQUIREMENTS
MOUNTING KIT R102 TRIMLESS O.F.A.
iMAX® COVER

OPTIONS
LED POWER SUPPLY 700-1050mA-DC / DIM

ACCESSORIES
iMAX® ACCESSORIES



MAX® ADJUSTABLE TRIMLESS C50 + iMAX® COVER ROUND TRIMLESS B

FULL INFO / PAG 15

Requirements

MOUNTING KIT R102 TRIMLESS O.F.A.
400 91 02 OFA

133

0,4

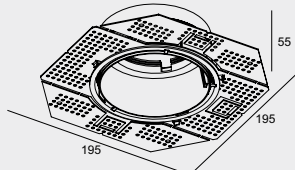

iMAX® COVER ROUND TRIMLESS ◊
400 00 30 ◊
◊ = B / MMAT / W
IP20

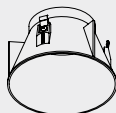

FULL INFO / PAG TEC

Options

CONTROL GEAR



TRANSFO 50W 86 x 31 x 20
200 46 06

TRANSFO 100W 107 x 35 x 21
200 46 10

BALLASTSET C50 20 4,0 kV 140 x 67 x 31
200 44 21

BALLASTSET C50 35 4,0 kV 140 x 67 x 31
200 44 36

FULL INFO / PAG TEC

Accessories



CLIP 50 ◊ Ø50 / H12
201 30 98 ◊
◊ = A / B / W

DICROIC FILTER 50 Ø50 max. 20W
201 30 11 ●
201 30 12 ●
201 30 13 ●
201 30 14 ●

iMax® Adjustable Trimless 50

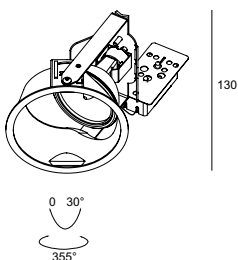
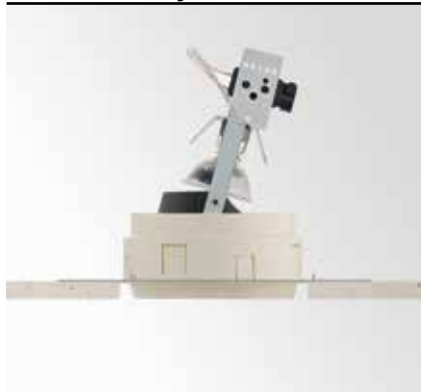

ØKIT x 150 max.25

iMAX® ADJUSTABLE TRIMLESS 50

403 60 00

ADJUSTABLE 0-30° / 355°
GX5.3 / 12V / EXCL.TRANSFO

1 x QR-C51 max.50W

CE 0,2 0,5

REQUIREMENTS

MOUNTING KIT R102 TRIMLESS O.F.A.
iMAX® COVER

OPTIONS

TRANSFO

led LED SOLUTION - PAG TEC 13

ACCESSORIES (max. 35W)

CLIP 50 + DICROIC FILTER 50

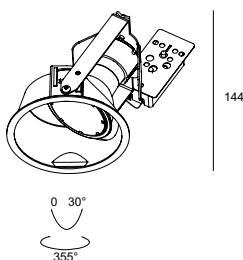

ØKIT x 150 max.25

iMAX® ADJUSTABLE TRIMLESS 50Hi

403 61 00

ADJUSTABLE 0-30° / 355°
GU10 / 100-240V / 50-60Hz

1 x QPAR51 max.35W

CE 0,2 0,5

REQUIREMENTS

MOUNTING KIT R102 TRIMLESS O.F.A.
iMAX® COVER

OPTIONS

led LED SOLUTION - PAG TEC 13

iMax® Adjustable Trimless C50

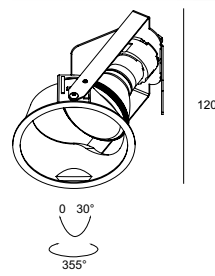
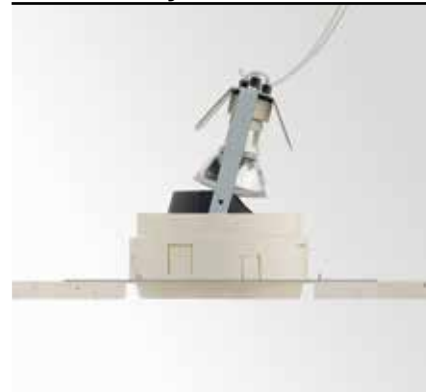

ØKIT x 150 max.25

iMAX® ADJUSTABLE TRIMLESS C50

403 80 00

ADJUSTABLE 0-30° / 355°
GX10 / EXCL.EVG

1 x HIPAR51 max.35W

CE 0,2 0,5

REQUIREMENTS

MOUNTING KIT R102 TRIMLESS O.F.A.
iMAX® COVER

OPTIONS

BALLASTSET C50

iMAX[®] WALLWASH

Optimal cooling for 800 or 1300Lm, respecting minimal recessed depth.

Using advanced led engines, delivering high performance, maximum efficacy and high quality illumination. Available in different colour temperatures, CRI and output levels. Color Consistency 2SDCM / 3SDCM

Standard softening lens for upgraded light quality

Interchangeable round front cover, available in white, black and gold combinations.



LED

Product Reference404

LED

01 08 Bridgelux Reflector 800
11 13 Xicato Reflector 1300

CRI

8 CRI>80
9 CRI>90 (Xicato CRI>95)

Colour Temperature

2 2700K ●
3 3000K ●
4 4000K ● (on request)

Beam Angle

1 Flood (only for Reflector-types / except Xicato)
2 Wide Flood



Requirement Reference400 00 ◇

Cover

41 Round Wallwash

Colour

B-B Black-Black
B-MMAT Black-Gold Mat
W-B White-Black
W-MMAT White-Gold Mat
W-W White-White





iMAX® WALLWASH BR8 + MAX® COVER ROUND WALLWASH W-B

FULL INFO / PAG 15

Requirements

iMAX® COVER ROUND WALLWASH ◊

400 00 41 ◊

◊ = B-B / B-MMAT / W-W / W-B / W-MMAT

IP43



FULL INFO / PAG TEC

Options

CONTROL GEAR



LED POWER SUPPLY 115 x 34 x 19
350mA-DC / 15W
300 90 91

LED POWER SUPPLY 76 x 34 x 24
350mA-DC / 16W Dim8
300 90 3112

LED POWER SUPPLY 111 x 38 x 28
350mA-DC / 17W
300 90 913

LED POWER SUPPLY 81 x 35 x 23
350mA-DC / 18W
300 90 112

LED POWER CONVERTER 90 x 53 x 58
24V-DC → MULTI CURRENT / 48W DIM9
300 90 67

LED POWER SUPPLY 111 x 38 x 28
500mA-DC / 20W
300 90 92

LED POWER SUPPLY 8 x 56 x 24
50mA-DC / 32W Dim8
300 90 5120

LED POWER SUPPLY 103 x 67 x 21
MULTI-POWER Dim1
300 90 64

124,5 x 79 x 22

9 4

LED POWER SUPPLY 165 x 47 x 35
6
300 90 61

03 67 1

0

LED POWER SUPPLY 111 x 79 x 22
MULTI-POWER Dim9
300 90 63

DIM1: dimming by 1-10V

DIM6: dimming by push button / falling edge dimmer

DIM7: dimming by push button / 1-10V

DIM8: dimming by falling edge dimmer

DIM9: dimming by push button / 1-10V / Dali

led iMax® Wallwash BR

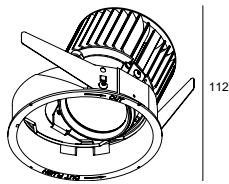
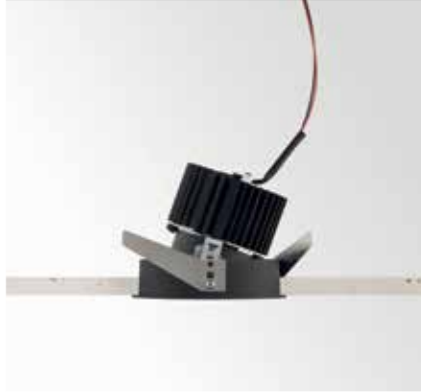

98 x 120 max.25

led iMax® Wallwash XR

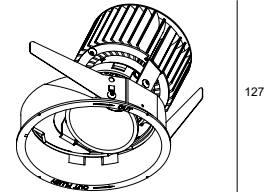

98 x 135 max.25

	CRI > 80	CRI > 90
4000K	ON REQUEST	
3000K	660 lm (7W) 920 lm (10W)	580 lm (7W) 810 lm (10W)
REFLECTOR FL-29°	iMAX® WALLWASH BR8 83029 404 01 08 831	iMAX® WALLWASH BR8 93029 404 01 08 931
REFLECTOR WFL-43°	iMAX® WALLWASH BR8 83043 404 01 08 832	iMAX® WALLWASH BR8 93043 404 01 08 932
2700K	620 lm (7W) 865 lm (10W)	525 lm (7W) 735 lm (10W)
REFLECTOR FL-29°	iMAX® WALLWASH BR8 82729 404 01 08 821	iMAX® WALLWASH BR8 92729 404 01 08 921
REFLECTOR WFL-43°	iMAX® WALLWASH BR8 82743 404 01 08 822	iMAX® WALLWASH BR8 92743 404 01 08 922

FIXED 25°
INCL. 1 x POWERLED WHITE 7-10W BRIDGELUX
EXCL. LED POWER SUPPLY 350-500mA-DC



REQUIREMENTS
iMAX® COVER

OPTIONS
LED POWER SUPPLY 350-500mA-DC / DIM

	CRI > 80	CRI > 95
4000K	ON REQUEST	
3000K	700 lm	700 lm
REFLECTOR FL-29°	iMAX® WALLWASH XR13 83043 404 11 13 832	iMAX® WALLWASH XR13 93043 404 11 13 932
REFLECTOR WFL-43°	iMAX® WALLWASH XR13 82743 404 11 13 822	iMAX® WALLWASH XR13 92743 404 11 13 922

FIXED 25°
INCL. 1 x POWERLED WHITE 8W XICATO
EXCL. LED POWER SUPPLY 500mA-DC

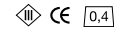

REQUIREMENTS
iMAX® COVER

OPTIONS
LED POWER SUPPLY 500mA-DC / DIM

iMAX® +

The iMax®+ takes all the advantages of the Soft Ceiling® concept and combines it with Delta Light's unique Ex-centric Rotation System (ERS) - as featured in the Tweeter . This patented mechanism upgrades the rotation movement and guarantees advanced lighting abilities, while the double shell design prevents ceiling exposure throughout all positions.







MAX®+ BR8 W-B + HONEYCOMB 50



FULL INFO / PAG TEC

Options

INSTALLATION			
PLASTERKIT 164 207 01 164	230 x 230	200 x 200	
CONTROL GEAR			
LED POWER SUPPLY 350mA-DC / 15W 300 90 91	115 x 34 x 19		
LED POWER SUPPLY 350mA-DC / 16W Dim8 300 90 3112	76 x 34 x 24		
350mA-DC / 17W 3	1	8 2	
LED POWER SUPPLY 1 2	81 x 35 x 23		
LED POWER CONVERTER 24V-DC → MULTI CURRENT / 48W DIM9 300 90 67	90 x 53 x 58		
LED POWER SUPPLY 500mA-DC / 20W 300 90 92	111 x 38 x 28		
LED POWER SUPPLY 500mA-DC / 32W Dim8 300 90 5120	86 x 56 x 24		
700mA-DC / 12W 300 90 43	1	40 3	
LED POWER SUPPLY 700mA-DC / 17W 300 90 93	111 x 38 x 28		
LED POWER SUPPLY 300 90 123	133 x 40 x 30		
LED POWER SUPPLY MULTI-POWER 300 90 914	124,5 x 79 x 22		
700mA-DC / 32W Dim8 7120	86 x 56 x 24		
9 4	124,5 x 79 x 22		
1 6	65 4 35		
LED POWER SUPPLY 7 0	103 x 67 x 21		
LED POWER SUPPLY MULTI-POWER Dim9 300 90 63	111 x 79 x 22		

FULL INFO / PAG 50

Accessories

- HONEYCOMB 50** 
- 413 03 01 
-  = B
- LINEAR SPREAD LENS 50**
413 03 02
- SPREAD LENS 50**
413 03 03
- SOFTENING LENS 50**
413 03 04
- GLASS SBL 50**
413 03 05



30°
ADJUSTABLE
& LOCKABLE

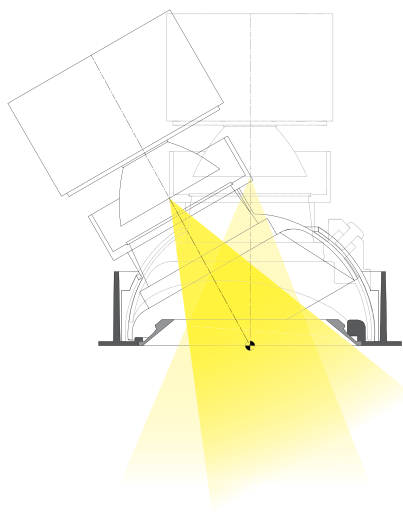

4000K 

3000K 

LENS SP-6°

LENS SP-10°

REFLECTOR FL-29°

REFLECTOR WFL-43°

2700K 

LENS SP-6°

LENS SP-10°

REFLECTOR FL-29°

REFLECTOR WFL-43°

DIM1: dimming by 1-10V
 DIM6: dimming by push button / falling edge dimmer
 DIM7: dimming by push button / 1-10V
 DIM8: dimming by falling edge dimmer
 DIM9: dimming by push button / 1-10V / Dali

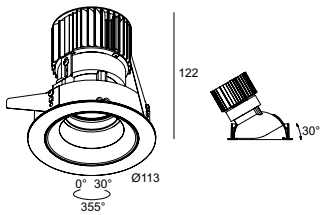

ⓘ 105 x 130 📏 max.25

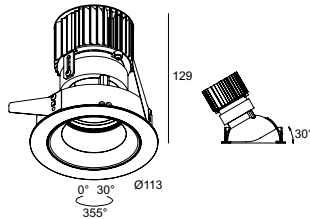

ⓘ 105 x 135 📏 max.25

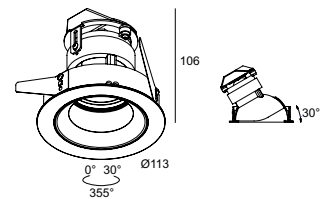

ⓘ 105 x 110 📏 max.25

CRI > 80		CRI > 90	
ON REQUEST			
660 lm (7W) 920 lm (10W)	580 lm (7W) 810 lm (10W)		
iMAX® + BR8 83029 ◇ 413 01 08 831 ◇ ◇=B/B/B/C/B/M/WB/WC/WM	iMAX® + BR8 93029 ◇ 413 01 08 931 ◇ ◇=B/B/B/C/B/M/WB/WC/WM		
iMAX® + BR8 83043 ◇ 413 01 08 832 ◇ ◇=B/B/B/C/B/M/WB/WC/WM	iMAX® + BR8 93043 ◇ 413 01 08 932 ◇ ◇=B/B/B/C/B/M/WB/WC/WM		
620 lm (7W) 865 lm (10W)	525 lm (7W) 735 lm (10W)		
iMAX® + BR8 82729 ◇ 413 01 08 821 ◇ ◇=B/B/B/C/B/M/WB/WC/WM	iMAX® + BR8 92729 ◇ 413 01 08 921 ◇ ◇=B/B/B/C/B/M/WB/WC/WM		
iMAX® + BR8 82743 ◇ 413 01 08 822 ◇ ◇=B/B/B/C/B/M/WB/WC/WM	iMAX® + BR8 92743 ◇ 413 01 08 922 ◇ ◇=B/B/B/C/B/M/WB/WC/WM		

 ADJUSTABLE 0-30° / 355°
 INCL. 1 x POWERLED WHITE 7-10W BRIDGELUX
 EXCL. LED POWER SUPPLY 350-500mA-DC

OPTIONS
 PLASTERKIT 164
 LED POWER SUPPLY 350-500mA-DC / DIM

ACCESSORIES
 HONEYCOMB 50
 LINEAR SPREAD LENS 50
 SPREAD LENS 50
 SOFTENING LENS 50
 GLASS SBL 50

CRI > 80		CRI > 90	
ON REQUEST			
585 lm	485 lm		
iMAX® + BL4 83010 ◇ 413 02 04 839 ◇ ◇=B/B/B/C/B/M/WB/WC/WM	iMAX® + BL4 93010 ◇ 413 02 04 939 ◇ ◇=B/B/B/C/B/M/WB/WC/WM		
565 lm	455 lm		
iMAX® + BL4 82710 ◇ 413 02 04 829 ◇ ◇=B/B/B/C/B/M/WB/WC/WM	iMAX® + BL4 92710 ◇ 413 02 04 929 ◇ ◇=B/B/B/C/B/M/WB/WC/WM		

 ADJUSTABLE 0-30° / 355°
 INCL. 1 x POWERLED WHITE 7W BRIDGELUX
 EXCL. LED POWER SUPPLY 700mA-DC

OPTIONS
 PLASTERKIT 164
 LED POWER SUPPLY 700mA-DC / DIM

ACCESSORIES
 HONEYCOMB 50
 LINEAR SPREAD LENS 50
 SPREAD LENS 50
 SOFTENING LENS 50
 GLASS SBL 50

CRI > 80		CRI > 90	
ON REQUEST			
223 lm (3W) 297 lm (4W)	200 lm (3W) 267 lm (4W)		
iMAX® + CL 83006 ◇ 413 22 02 839 ◇ ◇=B/B/B/C/B/M/WB/WC/WM	iMAX® + CL 93006 ◇ 413 22 02 939 ◇ ◇=B/B/B/C/B/M/WB/WC/WM		
208 lm (3W) 277 lm (4W)	187 lm (3W) 249 lm (4W)		
iMAX® + CL 82706 ◇ 413 22 02 829 ◇ ◇=B/B/B/C/B/M/WB/WC/WM	iMAX® + CL 92706 ◇ 413 22 02 929 ◇ ◇=B/B/B/C/B/M/WB/WC/WM		

 ADJUSTABLE 0-30° / 355°
 INCL. 1 x POWERLED WHITE 3-4W CREE
 EXCL. LED POWER SUPPLY 700-1050mA-DC

OPTIONS
 PLASTERKIT 164
 LED POWER SUPPLY 700-1050mA-DC / DIM

ACCESSORIES
 HONEYCOMB 50
 LINEAR SPREAD LENS 50
 SPREAD LENS 50
 SOFTENING LENS 50
 GLASS SBL 50

iMAX[®]+ ACCESSORIES

Honeycomb 50



HONEYCOMB 50 ◇

413 03 01 ◇

◇ = B

0,1

Linear Spread Lens 50



LINEAR SPREAD LENS 50

413 03 02

0,1

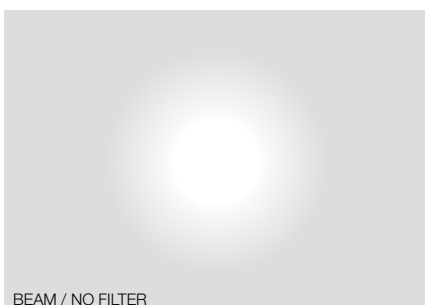

BEAM / NO FILTER

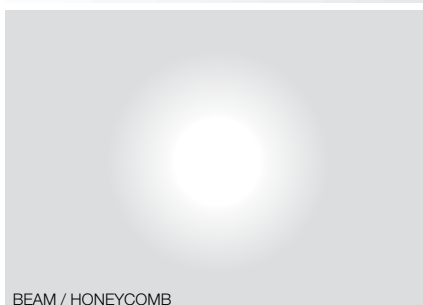

BEAM / HONEYCOMB

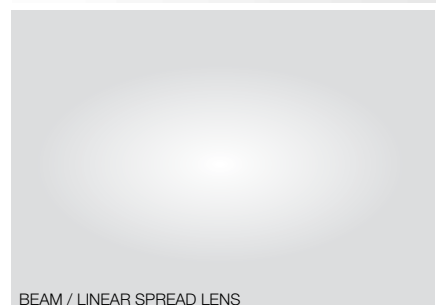

BEAM / LINEAR SPREAD LENS



Spread Lens 50

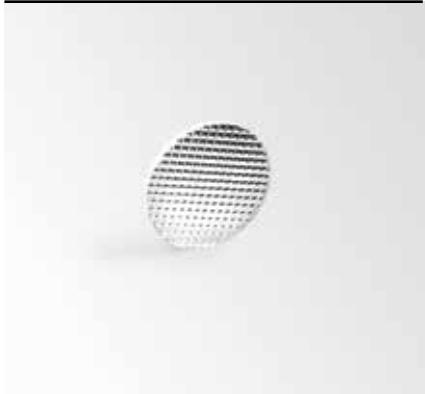

Ø50

SPREAD LENS 50
413 03 03

0,1

Softening Lens 50

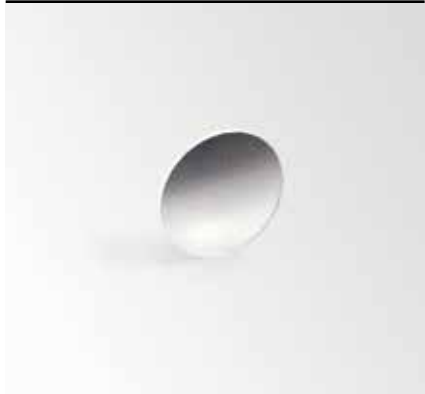

Ø50

SOFTENING LENS 50
413 03 04

0,1

Glass SBL 50

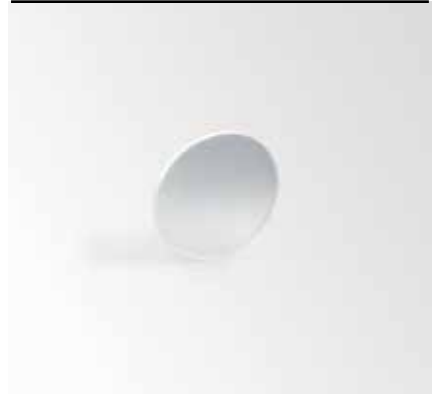

Ø50

GLASS SBL 50
413 03 05

0,1

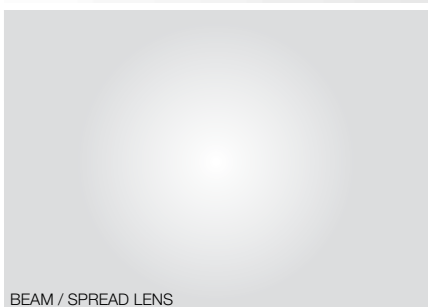

BEAM / SPREAD LENS



BEAM / SOFTENING LENS



BEAM / GLASS SBL



FULL INFO / PAG TEC

Options

CONTROL GEAR		
LED POWER SUPPLY 350mA-DC / 15W 300 90 91	115 x 34 x 19	
LED POWER SUPPLY 350mA-DC / 16W Dim8 300 90 3112	76 x 34 x 24	
LED POWER SUPPLY 350mA-DC / 17W 300 90 913	111 x 38 x 28	
LED POWER SUPPLY 50mA-DC / 18W 300 90 112	81 x 35 x 23	
LED POWER CONVERTER 24V-DC → MULTI CURRENT / 48W DIM9 300 90 67	90 x 53 x 58	
LED POWER SUPPLY 500mA-DC / 20W 300 90 92	111 x 38 x 28	
LED POWER SUPPLY 500mA-DC / 32W Dim8 300 90 5120	86 x 56 x 24	
LED POWER SUPPLY MULTI-POWER 300 90 914	124,5 x 79 x 22	
L E PPLY MULTI-POWER Dim1 300 90 64	03 67 1	
L E PPLY MULTI-POWER Dim6 3 0 61	65 47 5	
L E PPLY MULTI-POWER Dim7 3 0 60	103 x 67 x 2	
LED POWER SUPPLY M L I - W Dim9 300 90 63	111 x 79 x 22	



Mini Spy

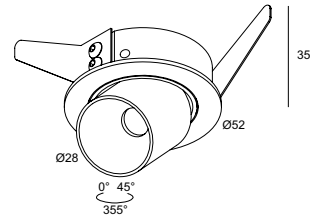

Ø46 x 40 max.25

MINI SPY ◇

414 13 839 ◇

◇ = W-W

ADJUSTABLE 0-45° / 355°

INCL.1 x POWERLED WHITE 1-2W / 3000K ●

INCL.1 x LENS 19°

EXCL.LED POWER SUPPLY 350-500mA-DC

CE 0.1 IP20

OPTIONS

LED POWER SUPPLY 350-500mA-DC / DIM

PATENTED EX-CENTRIC ROTATION SYSTEM®



FULL INFO / PAG TEC

Requirements

MOUNTING KIT R102 TRIMLESS O.F.A.
400 91 02 OFA

133

0,4

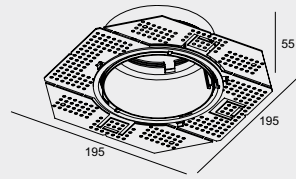

SPY TUBE ◇
414 01 00 ◇
◇ = B / MMAT / W



FULL INFO / PAG TEC

Options

INSTALLATION

PLASTERKIT 118 280 x 280 220 x 220

CONTROL GEAR

LED POWER SUPPLY 115 x 34 x 19
350mA-DC / 15W
300 90 91

LED POWER SUPPLY 76 x 34 x 24
350mA-DC / 16W Dim8
300 90 312

LED POWER SUPPLY 111 x 38 x 28
350mA-DC / 17W
300 90 913

LED POWER SUPPLY 81 x 35 x 23
350mA-DC / 18W
300 90 112

LED POWER CONVERTER 90 x 53 x 58
24V-DC → MULTI CURRENT / 48W DIM9
300 90 67

LED POWER SUPPLY 111 x 38 x 28
500mA-DC / 20W
300 90 92

LED POWER SUPPLY 86 x 56 x 24
500mA-DC / 32W Dim8
300 90 5120

D POW U 124,5 x 79 x 22
MULTI-POWER
0 914

LED POWER SUPPLY 103 x 67 x 21
MULTI-POWER Dim1
300 90 64

D POW U 65 x 7 5
MULTI-POWER Dim6
0 61

D POW U 103 x 67 x 2
MULTI-POWER Dim7
0 60

D POW U 111 x 79 x 22
U T PO ER Dim9
0 63

FULL INFO / PAG 50

Accessories

HONEYCOMB 50 ◇
413 03 01 ◇
◇ = B

LINEAR SPREAD LENS 50
413 03 02

SPREAD LENS 50
413 03 03

SOFTENING LENS 50
413 03 04

GLASS SBL 50
413 03 05

DIM1: dimming by 1-10V
DIM6: dimming by push button / falling edge dimmer
DIM7: dimming by push button / 1-10V
DIM8: dimming by falling edge dimmer
DIM9: dimming by push button / 1-10V / Dali

4000K ●

3000K ●

REFLECTOR FL-33°

2700K ●

REFLECTOR FL-33°

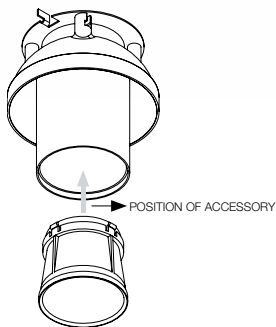



Spy Trimless

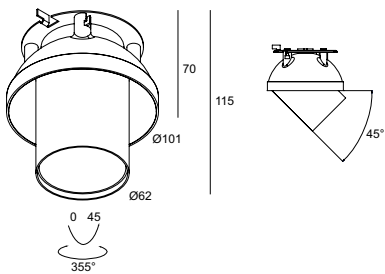

ⓘ Ø KIT x 80

CRI > 80

CRI > 90

ON REQUEST

660 lm (7W)
920 lm (10W)

SPY TRIMLESS 3033 ◇
414 31 832 ◇
◇ = W

620 lm (7W)
865 lm (10W)

SPY TRIMLESS 2733 ◇
414 31 822 ◇
◇ = W

580 lm (7W)
810 lm (10W)

SPY TRIMLESS 3033-9 ◇
414 31 932 ◇
◇ = W

525 lm (7W)
735 lm (10W)

SPY TRIMLESS 2733-9 ◇
414 31 922 ◇
◇ = W

ADJUSTABLE 0-45° / 355°
INCL. 1 x POWERLED WHITE 7-10W
EXCL. LED POWER SUPPLY 350-500mA-DC

ⓘ CE 0.7 IP20

REQUIREMENTS
MOUNTING KIT R102 TRIMLESS O.F.A.
400 91 02 OFA
SPY TUBE
414 01 00

OPTIONS
LED POWER SUPPLY 350-500mA-DC / DIM

ACCESSORIES
HONEYCOMB 50
LINEAR SPREAD LENS 50
SPREAD LENS 50
SOFTENING LENS 50
GLASS SBL 50



Spy ST

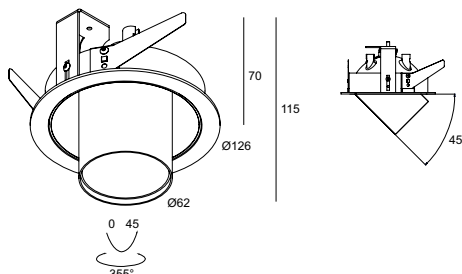

ⓘ 114x 80 max.25

CRI > 80

CRI > 90

ON REQUEST

660 lm (7W)
920 lm (10W)

SPY ST 3033 ◇
414 33 832 ◇
◇ = W-W

620 lm (7W)
865 lm (10W)

SPY ST 2733 ◇
414 33 822 ◇
◇ = W-W

580 lm (7W)
810 lm (10W)

SPY ST 3033-9 ◇
414 33 932 ◇
◇ = W-W

525 lm (7W)
735 lm (10W)

SPY ST 2733-9 ◇
414 33 922 ◇
◇ = W-W

ADJUSTABLE 0-45° / 355°
INCL. 1 x POWERLED WHITE 7-10W
EXCL. LED POWER SUPPLY 350-500mA-DC

ⓘ CE 0.7 IP20

REQUIREMENTS
SPY TUBE
414 01 00

OPTIONS
LED POWER SUPPLY 350-500mA-DC / DIM

ACCESSORIES
HONEYCOMB 50
LINEAR SPREAD LENS 50
SPREAD LENS 50
SOFTENING LENS 50
GLASS SBL 50

PATENTED EX-CENTRIC ROTATION SYSTEM®









FULL INFO / PAG TEC

Requirements

INSTALLATION

MOUNTING KIT R82 TRIMLESS O.F.A.
202 11 82 OFA

122

0,2

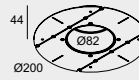

FULL INFO / PAG TEC

Options

INSTALLATION

PLASTERKIT 104
202 14 29



219 x 225

160 x 190

CONTROL GEAR

LED POWER SUPPLY
350mA-DC / 15W
300 90 91

115 x 34 x 19

LED POWER SUPPLY
3 0m -D 6W Dim8
3 0 90 3 12

76 x 34 x 24

LED POWER SUPPLY
3 0m -D 7W
3 0 90 9 3

111 x 38 x 28

LED POWER SUPPLY
3 0m -D 8W
3 0 90 1 2

81 x 35 x 23

LED POWER CONVERTER 90 x 53 x 58
24V-DC → MULTI CURRENT / 48W DIM9
300 90 67

LED POWER SUPPLY
MULTI-POWER
300 90 914

124,5 x 79 x 22

LED POWER SUPPLY
MULTI-POWER Dim1
300 90 64

103 x 67 x 21

LED POWER SUPPLY
MULTI-POWER Dim6
300 90 61

165 x 47 x 35

LED POWER SUPPLY
MULTI-POWER Dim7
300 90 60

103 x 67 x 21

LED POWER SUPPLY
MULTI-POWER Dim9
300 90 63

111 x 79 x 22

Fixation S1

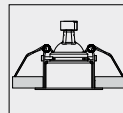

DIM1: dimming by 1-10V
DIM6: dimming by push button / falling edge dimmer
DIM7: dimming by push button / 1-10V
DIM8: dimming by falling edge dimmer
DIM9: dimming by push button / 1-10V / Dali

4000K ●

3000K ●

REFLECTOR FL-33°

2700K ●

REFLECTOR FL-33°



Diro Trimless LED

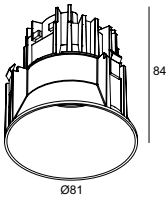

Ø KIT x 95

CRI > 80	CRI > 90
ON REQUEST	
660 lm	580 lm
DIRO TRIMLESS LED 3033 ◇ 202 144 28122 ◇ ◇ = MMAT / W	DIRO TRIMLESS LED 3033-9 ◇ 202 144 29122 ◇ ◇ = MMAT / W
620 lm	525 lm
DIRO TRIMLESS LED 2733 ◇ 202 144 28123 ◇ ◇ = MMAT / W	DIRO TRIMLESS LED 2733-9 ◇ 202 144 29123 ◇ ◇ = MMAT / W

FIXED
INCL. 1 x POWERLED WHITE 7W
EXCL. LED POWER SUPPLY 350mA-DC

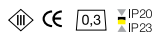

REQUIREMENTS
MOUNTING KIT R82 TRIMLESS O.F.A.
202 11 82 OFA

OPTIONS
LED POWER SUPPLY 350mA-DC / DIM



Diro Duo ST OK LED

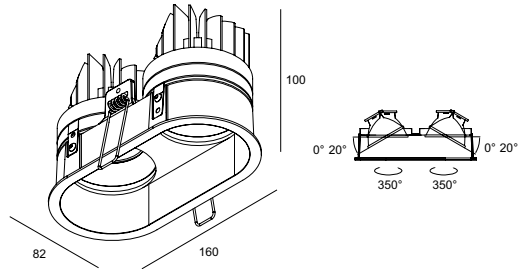

153 x 75 x 110 max.22

CRI > 80	CRI > 90
ON REQUEST	
2 x 660 lm	2 x 580 lm
DIRO DUO ST OK LED 3033 S1 ◇ 202 292 28222 ◇ ◇ = MMAT / W	DIRO DUO ST OK LED 3033-9 S1 ◇ 202 292 29222 ◇ ◇ = MMAT / W
2 x 620 lm	2 x 525 lm
DIRO DUO ST OK LED 2733 S1 ◇ 202 292 28223 ◇ ◇ = MMAT / W	DIRO DUO ST OK LED 2733-9 S1 ◇ 202 292 29223 ◇ ◇ = MMAT / W

2 x ADJUSTABLE 0°-20° / 350°
INCL. 2 x POWERLED WHITE 7W
EXCL. LED POWER SUPPLY 350mA-DC

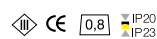

OPTIONS
PLASTERKIT 104
LED POWER SUPPLY 350mA-DC / DIM



FULL INFO / PAG TEC

Requirements

MOUNTING KIT 75 TRIMLESS 202 01 75

121 9 or 12

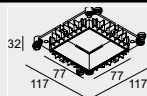

0,1

MOUNTING KIT 75 TRIMLESS O.F.A. 202 01 75 OFA

182

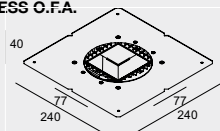

0,2

FULL INFO / PAG TEC

Options

CONTROL GEAR



LED POWER SUPPLY
350mA-DC / 15W
300 90 91

115 x 34 x 19

6 Dim8

76 x 34 x 24

3 12

LED POWER SUPPLY
7

111 x 38 x 28

300 90 913

8

81 x 35 x 23

1 2

LED POWER CONVERTER
24V-DC → MULTI CURRENT / 48W DIM9
300 90 67

90 x 53 x 58

LED POWER SUPPLY
MULTI-POWER
300 90 914

124,5 x 79 x 22

LED POWER SUPPLY
MULTI-POWER Dim1
300 90 64

103 x 67 x 21

LED POWER SUPPLY
MULTI-POWER Dim6
300 90 61

165 x 47 x 35

LED POWER SUPPLY
MULTI-POWER Dim7
300 90 60

103 x 67 x 21

LED POWER SUPPLY
MULTI-POWER Dim9
300 90 63

111 x 79 x 22

DIM1: dimming by 1-10V
DIM6: dimming by push button / falling edge dimmer
DIM7: dimming by push button / 1-10V
DIM8: dimming by falling edge dimmer
DIM9: dimming by push button / 1-10V / Dali



Carree Trimless OK LED

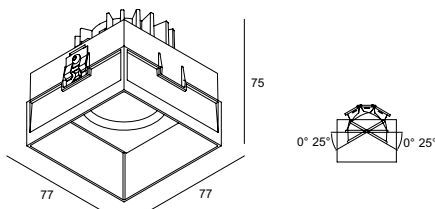

Ø KIT x 85

CRI > 80

CRI > 90

	CRI > 80	CRI > 90
4000K	ON REQUEST	
3000K	660 lm	580 lm
REFLECTOR FL-33°	CARREE TRIMLESS OK LED 3033 ◇ 202 510 28122 ◇ ◇ = A / W	CARREE TRIMLESS OK LED 3033-9 ◇ 202 510 29122 ◇ ◇ = A / W
2700K	620 lm	525 lm
REFLECTOR FL-33°	CARREE TRIMLESS OK LED 2733 ◇ 202 510 28123 ◇ ◇ = A / W	CARREE TRIMLESS OK LED 2733-9 ◇ 202 510 29123 ◇ ◇ = A / W

ADJUSTABLE 0° - 25°
INCL. 1 x POWERLED WHITE 7W
EXCL. LED POWER SUPPLY 350mA-DC

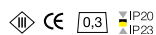

REQUIREMENTS

MOUNTING KIT 75 TRIMLESS
202 01 75
or
MOUNTING KIT 75 TRIMLESS O.F.A.
202 01 75 OFA

OPTIONS

LED POWER SUPPLY 350mA-DC / DIM

INSTALLATION IN CONCRETE / MOUNTING KIT 75 TRIMLESS O.F.A.

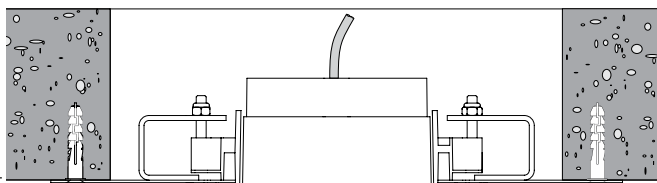

ADJUSTABLE 15mm I



FULL INFO / PAG TEC

Options

INSTALLATION



PLASTERKIT 161 207 01 161	200 x 200	175 x 175
CONCRETE BOX 161 270 11 161	202 x 202 x 186	207 x 207
MOUNTING KIT 75 202 00 75	117 x 117 x 22	Ø121

CONTROL GEAR



LED POWER SUPPLY 350mA-DC / 15W 300 90 91	115 x 34 x 19	
350mA-DC / 16W Dim8 3 12	76 x 34 x 24	
LED POWER SUPPLY 9 3	111 x 38 x 28	
8 1 2	81 x 35 x 23	
LED POWER CONVERTER 24V-DC → MULTI CURRENT / 48W DIM9 300 90 67	90 x 53 x 58	
LED POWER SUPPLY MULTI-POWER 300 90 914	124,5 x 79 x 22	
LED POWER SUPPLY MULTI-POWER Dim1 300 90 64	103 x 67 x 21	
LED POWER SUPPLY MULTI-POWER Dim6 300 90 61	165 x 47 x 35	
LED POWER SUPPLY MULTI-POWER Dim7 300 90 60	103 x 67 x 21	
LED POWER SUPPLY MULTI-POWER Dim9 300 90 63	111 x 79 x 22	

- 4000K ●
- 3000K ●
- REFLECTOR FL-33°
- 2700K ●
- REFLECTOR FL-33°

Fixation S1

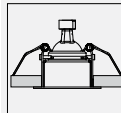

Fixation S2

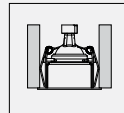

- DIM1: dimming by 1-10V
- DIM6: dimming by push button / falling edge dimmer
- DIM7: dimming by push button / 1-10V
- DIM8: dimming by falling edge dimmer
- DIM9: dimming by push button / 1-10V / Dali

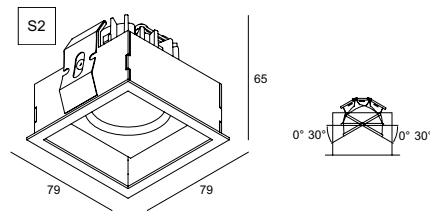
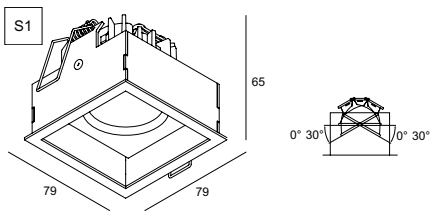

75 x 75 x 75 max.35

75 x 75 x 75

CRI > 80

CRI > 90

CRI > 80

CRI > 90

ON REQUEST

ON REQUEST

660 lm

580 lm

660 lm

580 lm

CARREE ST OK LED 3033 S1
202 501 28122
 ◇ = A / W

CARREE ST OK LED 3033-9 S1
202 501 29122
 ◇ = A / W

CARREE ST OK LED 3033 S2
202 502 28122
 ◇ = A / W

CARREE ST OK LED 3033-9 S2
202 502 29122
 ◇ = A / W

620 lm

525 lm

620 lm

525 lm

CARREE ST OK LED 2733 S1
202 501 28123
 ◇ = A / W

CARREE ST OK LED 2733-9 S1
202 501 29123
 ◇ = A / W

CARREE ST OK LED 2733 S2
202 502 28123
 ◇ = A / W

CARREE ST OK LED 2733-9 S2
202 502 29123
 ◇ = A / W

ADJUSTABLE 0°- 30°
 INCL. 1 x POWERLED WHITE 7W
 EXCL. LED POWER SUPPLY 350mA-DC

ADJUSTABLE 0°- 30°
 INCL. 1 x POWERLED WHITE 7W
 EXCL. LED POWER SUPPLY 350mA-DC

OPTIONS
 PLASTERKIT 161
 CONCRETE BOX 161
 LED POWER SUPPLY 350mA-DC / DIM

OPTIONS
 PLASTERKIT 161
 CONCRETE BOX 161
 MOUNTING KIT 75
 LED POWER SUPPLY 350mA-DC / DIM



FULL INFO / PAG TEC

Options

INSTALLATION



PLASTERKIT 161 207 01 161	200 x 200	175 x 175
CONCRETE BOX 161 270 11 161	202 x 202 x 186	207 x 207
MOUNTING KIT 75 202 00 75	117 x 117 x 22	Ø121

CONTROL GEAR



LED POWER SUPPLY 350mA-DC / 15W 300 90 91	115 x 34 x 19
6 Dim8	76 x 34 x 24
3 12	
350mA-DC / 17W 9 3	111 x 38 x 28
8	81 x 35 x 23
1 2	
LED POWER CONVERTER 24V-DC → MULTI CURRENT / 48W DIM9 300 90 67	90 x 53 x 58
LED POWER SUPPLY MULTI-POWER 300 90 914	124,5 x 79 x 22
LED POWER SUPPLY MULTI-POWER Dim1 300 90 64	103 x 67 x 21
LED POWER SUPPLY MULTI-POWER Dim6 300 90 61	165 x 47 x 35
LED POWER SUPPLY MULTI-POWER Dim7 300 90 60	103 x 67 x 21
LED POWER SUPPLY MULTI-POWER Dim9 300 90 63	111 x 79 x 22

4000K ●

3000K ●

REFLECTOR FL-33°

2700K ●

REFLECTOR FL-33°

Fixation S1

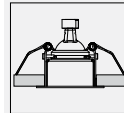

Fixation S2

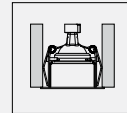

DIM1: dimming by 1-10V
 DIM6: dimming by push button / falling edge dimmer
 DIM7: dimming by push button / 1-10V
 DIM8: dimming by falling edge dimmer
 DIM9: dimming by push button / 1-10V / Dali

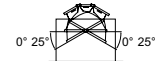
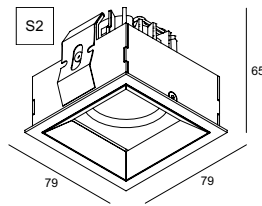
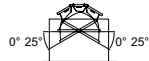
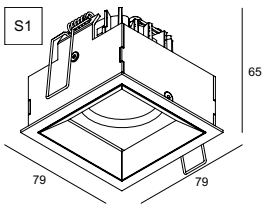

75 x 75 x 75 max.35

75 x 75 x 75

CRI > 80

CRI > 90

CRI > 80

CRI > 90

ON REQUEST

ON REQUEST

660 lm

580 lm

660 lm

580 lm

CARREE SC OK 3033 S1 ◊
202 471 28122 ◊
◊ = W-B

CARREE SC OK 3033-9 S1 ◊
202 471 29122 ◊
◊ = W-B

CARREE SC OK 3033 S2 ◊
202 472 28122 ◊
◊ = W-B

CARREE SC OK 3033-9 S2 ◊
202 472 29122 ◊
◊ = W-B

620 lm

525 lm

620 lm

525 lm

CARREE SC OK 2733 S1 ◊
202 471 28123 ◊
◊ = W-B

CARREE SC OK 2733-9 S1 ◊
202 471 29123 ◊
◊ = W-B

CARREE SC OK 2733 S2 ◊
202 472 28123 ◊
◊ = W-B

CARREE SC OK 2733-9 S2 ◊
202 472 29123 ◊
◊ = W-B

ADJUSTABLE 0°- 25°
INCL.1 x POWERLED WHITE 7W
EXCL.LED POWER SUPPLY 350mA-DC

ADJUSTABLE 0°- 25°
INCL.1 x POWERLED WHITE 7W
EXCL.LED POWER SUPPLY 350mA-DC

OPTIONS
PLASTERKIT 161
CONCRETE BOX 161
LED POWER SUPPLY 350mA-DC / DIM

OPTIONS
PLASTERKIT 161
CONCRETE BOX 161
MOUNTING KIT 75
LED POWER SUPPLY 350mA-DC / DIM



CONTROL GEAR



LED POWER SUPPLY 115 x 34 x 19
350mA-DC / 15W
300 90 91

6 Dim8 76 x 34 x 24
3 12
7 111 x 38 x 28
9 3

LED POWER SUPPLY 81 x 35 x 23
8
300 90 112

LED POWER CONVERTER 90 x 53 x 58
24V-DC → MULTI CURRENT / 48W DIM9
300 90 67

LED POWER SUPPLY 124,5 x 79 x 22
MULTI-POWER
300 90 914

LED POWER SUPPLY 103 x 67 x 21
MULTI-POWER Dim1
300 90 64

LED POWER SUPPLY 165 x 47 x 35
MULTI-POWER Dim6
300 90 61

LED POWER SUPPLY 103 x 67 x 21
MULTI-POWER Dim7
300 90 60

LED POWER SUPPLY 111 x 79 x 22
MULTI-POWER Dim9
300 90 63

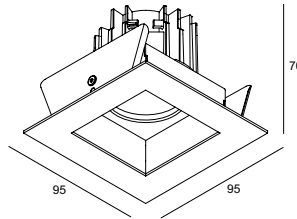

89 x 80 min.5

CRI > 80

CRI > 90

4000K

ON REQUEST

3000K

660 lm

580 lm

REFLECTOR FL-33°

CARREE Rs LED 3033 ◇
202 46 28122 ◇
 ◇ = A / W

CARREE Rs LED 3033-9 ◇
202 46 29122 ◇
 ◇ = A / W

2700K

620 lm

525 lm

REFLECTOR FL-33°

CARREE Rs LED 2733 ◇
202 46 28123 ◇
 ◇ = A / W

CARREE Rs LED 2733-9 ◇
202 46 29123 ◇
 ◇ = A / W

FIXED
 INCL.1 x POWERLED WHITE 7W
 EXCL.LED POWER SUPPLY 350mA-DC

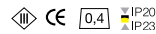

OPTIONS
 LED POWER SUPPLY 350mA-DC / DIM

DIM1: dimming by 1-10V
 DIM6: dimming by push button / falling edge dimmer
 DIM7: dimming by push button / 1-10V
 DIM8: dimming by falling edge dimmer
 DIM9: dimming by push button / 1-10V / Dali



FULL INFO / PAG TEC

Options

INSTALLATION



PLASTERKIT 189 160 x 247 x 12 190 x 85
207 01 189

CONCRETE BOX 189 160 x 247 x 76 165 x 255
270 11 189

CONTROL GEAR



LED POWER SUPPLY 115 x 34 x 19
350mA-DC / 15W
300 90 91

6 Dim8 76 x 34 x 24
3 12

7 111 x 38 x 28
9 3

LED POWER SUPPLY 81 x 35 x 23
8
1 2

LED POWER CONVERTER 90 x 53 x 58
24V-DC → MULTI CURRENT / 48W DIM9
300 90 67

LED POWER SUPPLY 124,5 x 79 x 22
MULTI-POWER
300 90 914

LED POWER SUPPLY 103 x 67 x 21
MULTI-POWER Dim1
300 90 64

LED POWER SUPPLY 165 x 47 x 35
MULTI-POWER Dim6
300 90 61

LED POWER SUPPLY 103 x 67 x 21
MULTI-POWER Dim7
300 90 60

LED POWER SUPPLY 111 x 79 x 22
MULTI-POWER Dim9
300 90 63

Fixation S1

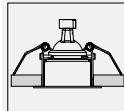

DIM1: dimming by 1-10V
DIM6: dimming by push button / falling edge dimmer
DIM7: dimming by push button / 1-10V
DIM8: dimming by falling edge dimmer
DIM9: dimming by push button / 1-10V / Dali



Carree 150 LED

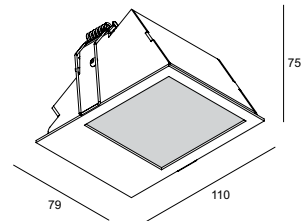

104 x 75 x 85 max.35

CARREE 150 LED S1 ◇

202 48 28 ◇

◇ = A / W

FIXED

INCL.LINEAR SPREAD LENS

INCL.1 x POWERLED WHITE 7W

EXCL.LED POWER SUPPLY 350mA-DC

CE 0,5 IP20 IP44 IP20 IP20

OPTIONS

PLASTERKIT 189

CONCRETE BOX 189

LED POWER SUPPLY 350mA-DC / DIM

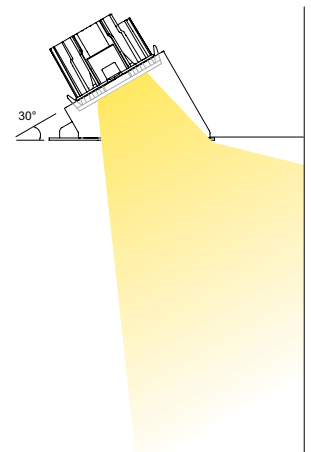



FULL INFO / PAG TEC

Requirements

INSTALLATION

GRID IN TRIMLESS 1 MOUNTING KIT HP
202 61 95 01 HP

173 x 173 max.25

0,5



GRID IN TRIMLESS 2 MOUNTING KIT HP
202 61 95 02 HP

312 x 173 max.25

0,7

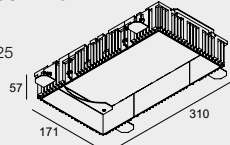

CONTROL GEAR



LED POWER SUPPLY 103 x 67 x 30
600-700mA-DC / 38W
300 90 66

LED POWER SUPPLY 103 x 67 x 30
600-700mA-DC / 35W Dim2
300 90 66 ED2

FULL INFO / PAG 132

Accessories

HONEYCOMB 87 ◇

201 01 01 ◇

◇ = B

LINEAR SPREAD LENS 87

201 01 02

SPREAD LENS 87

201 01 03

SOFTENING LENS 87

201 01 04

GLASS SBL 87

201 01 05

3000K ●

REFLECTOR FL-27°

REFLECTOR WFL-50°

DIM2: dimming by push button / Dali



HONEYCOMB 87

LINEAR SPREAD LENS 87

SPREAD LENS 87

SOFTENING LENS 87

GLASS SBL 87

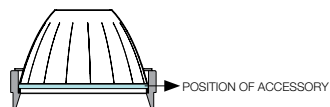

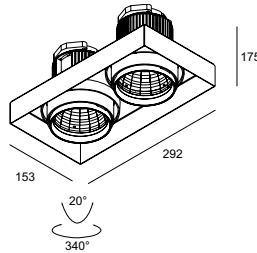
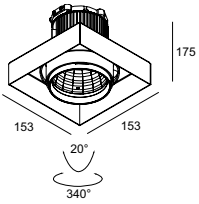

KIT x 180

KIT x 180

KIT x 180		KIT x 180	
CRI > 80	CRI > 90	CRI > 80	CRI > 90
3000 lm (29W)	3000 lm (33W)	2x 3000 lm (2x 29W)	2x 3000 lm (2x 33W)
GRID IN TRIMLESS 1 HP 303027 ◇ 202 684 20122 ◇ ◇ = W-B	GRID IN TRIMLESS 1 HP 303027-9 ◇ 202 684 209122 ◇ ◇ = W-B	GRID IN TRIMLESS 2 HP 303027 ◇ 202 684 20222 ◇ ◇ = W-B	GRID IN TRIMLESS 2 HP 303027-9 ◇ 202 684 209222 ◇ ◇ = W-B
GRID IN TRIMLESS 1 HP 303050 ◇ 202 684 20132 ◇ ◇ = W-B	GRID IN TRIMLESS 1 HP 303050-9 ◇ 202 684 209132 ◇ ◇ = W-B	GRID IN TRIMLESS 2 HP 303050 ◇ 202 684 20232 ◇ ◇ = W-B	GRID IN TRIMLESS 2 HP 303050-9 ◇ 202 684 209232 ◇ ◇ = W-B
ADJUSTABLE 0° - 20° / 340° INCL. 1 x POWERLED WHITE EXCL. 1 x LED POWER SUPPLY 600mA-DC	ADJUSTABLE 0° - 20° / 340° INCL. 1 x POWERLED WHITE EXCL. 1 x LED POWER SUPPLY 700mA-DC	ADJUSTABLE 0° - 20° / 340° INCL. 2 x POWERLED WHITE EXCL. 2 x LED POWER SUPPLY 600mA-DC	ADJUSTABLE 0° - 20° / 340° INCL. 2 x POWERLED WHITE EXCL. 2 x LED POWER SUPPLY 700mA-DC
IP20 REQUIREMENTS GRID IN TRIMLESS 1 MOUNTING KIT HP 202 61 95 01 HP LED POWER SUPPLY 600-700mA-DC / 38W 300 90 66 or LED POWER SUPPLY 600-700mA-DC / 35W / DIM2 300 90 66 ED2 ACCESSORIES HONEYCOMB 87 LINEAR SPREAD LENS 87 SPREAD LENS 87 SOFTENING LENS 87 GLASS SBL 87		IP20 REQUIREMENTS GRID IN TRIMLESS 2 MOUNTING KIT HP 202 61 95 02 HP LED POWER SUPPLY 600-700mA-DC / 38W 300 90 66 or LED POWER SUPPLY 600-700mA-DC / 35W / DIM2 300 90 66 ED2 ACCESSORIES HONEYCOMB 87 LINEAR SPREAD LENS 87 SPREAD LENS 87 SOFTENING LENS 87 GLASS SBL 87	

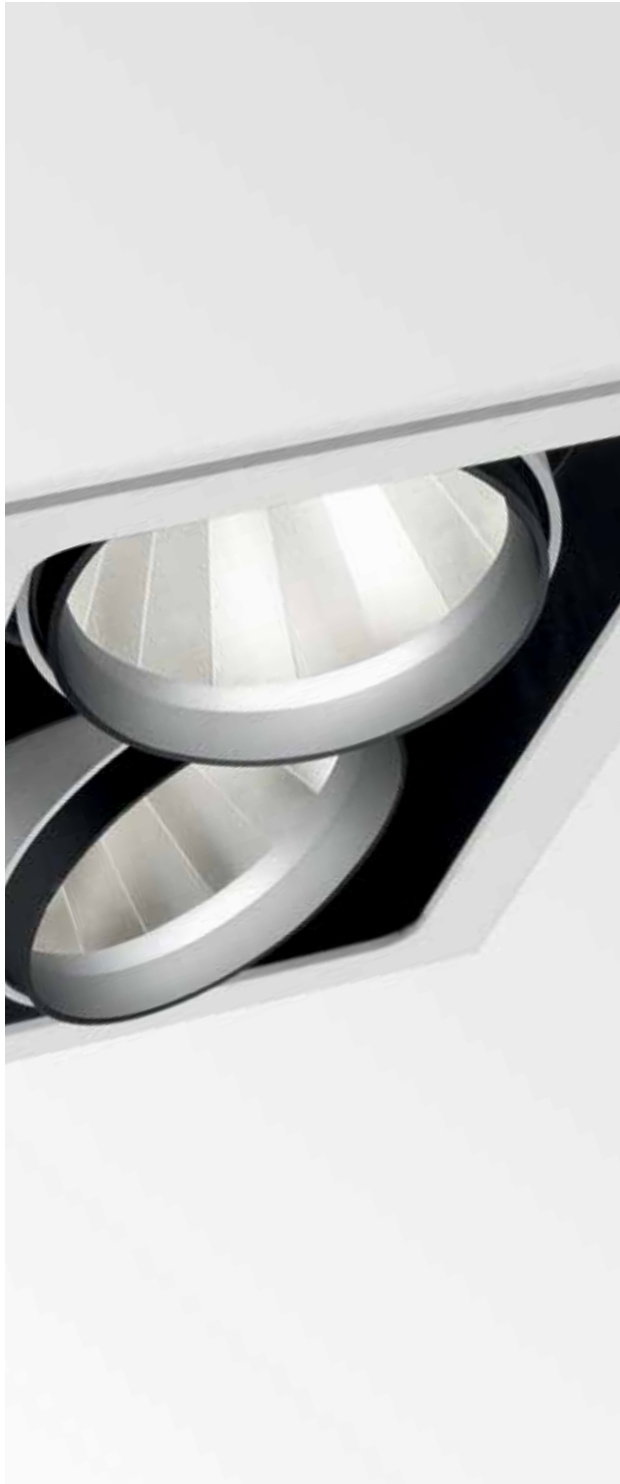

FULL INFO / PAG TEC

Options

INSTALLATION



PLASTERKIT 120 260 x 230 190 x 170
202 62 99 01

PLASTERKIT 121 260 x 399 190 x 310
202 62 99 02

CONTROL GEAR



LED POWER SUPPLY 103 x 67 x 30
600-700mA-DC / 38W
300 90 66

LED POWER SUPPLY 103 x 67 x 30
600-700mA-DC / 35W Dim2
300 90 66 ED2

FULL INFO / PAG 132

Accessories

HONEYCOMB 87 ◇

201 01 01 ◇
◇ = B

LINEAR SPREAD LENS 87

201 01 02

SPREAD LENS 87

201 01 03

SOFTENING LENS 87

201 01 04

GLASS SBL 87

201 01 05

3000K ●

REFLECTOR FL-27°

REFLECTOR WFL-50°

DIM2: dimming by push button / Dali

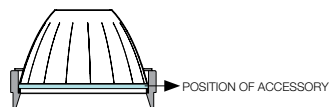

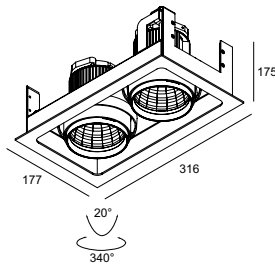
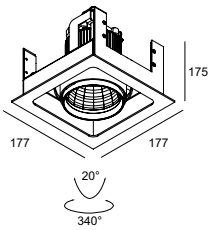

167 x 167 x 180 max.30

306 x 167 x 180 max.30

CRI > 80

CRI > 90

CRI > 80

CRI > 90

3000 lm (29W)

3000 lm (33W)

2x 3000 lm (2x 29W)

2x 3000 lm (2x 33W)

GRID IN 1 HP 303027 ◊
202 694 20122 ◊
◊ = W-B

GRID IN 1 HP 303027-9 ◊
202 694 209122 ◊
◊ = W-B

GRID IN 2 HP 303027 ◊
202 694 20222 ◊
◊ = W-B

GRID IN 2 HP 303027-9 ◊
202 694 209222 ◊
◊ = W-B

GRID IN 1 HP 303050 ◊
202 694 20132 ◊
◊ = W-B

GRID IN 1 HP 303050-9 ◊
202 694 209132 ◊
◊ = W-B

GRID IN 2 HP 303050 ◊
202 694 20232 ◊
◊ = W-B

GRID IN 2 HP 303050-9 ◊
202 694 209232 ◊
◊ = W-B

ADJUSTABLE 0°- 20° / 340°
INCL. 1 x POWERLED WHITE
EXCL. 1 x LED POWER SUPPLY 600mA-DC

ADJUSTABLE 0°- 20° / 340°
INCL. 1 x POWERLED WHITE
EXCL. 1 x LED POWER SUPPLY 700mA-DC

ADJUSTABLE 0°- 20° / 340°
INCL. 2 x POWERLED WHITE
EXCL. 2 x LED POWER SUPPLY 600mA-DC

ADJUSTABLE 0°- 20° / 340°
INCL. 2 x POWERLED WHITE
EXCL. 2 x LED POWER SUPPLY 700mA-DC

IP20

IP20

REQUIREMENTS

LED POWER SUPPLY 600-700mA-DC / 38W
300 90 66

or

LED POWER SUPPLY 600-700mA-DC / 35W / DIM2
300 90 66 ED2

REQUIREMENTS

LED POWER SUPPLY 600-700mA-DC / 38W
300 90 66

or

LED POWER SUPPLY 600-700mA-DC / 35W / DIM2
300 90 66 ED2

OPTIONS

PLASTERKIT 120

OPTIONS

PLASTERKIT 121

ACCESSORIES

HONEYCOMB 87
LINEAR SPREAD LENS 87
SPREAD LENS 87
SOFTENING LENS 87
GLASS SBL 87

ACCESSORIES

HONEYCOMB 87
LINEAR SPREAD LENS 87
SPREAD LENS 87
SOFTENING LENS 87
GLASS SBL 87



Requirements

INSTALLATION

PITCH 162 RECESSED KIT 274 88 014

184 x 65 max.25

0,5

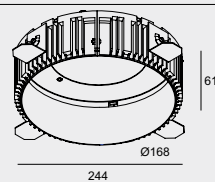

PITCH 162

+

=



PITCH 162 RECESSED KIT



PITCH 162 RECESSED



Pitch 162

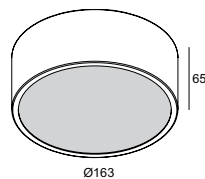

PITCH 162 ◇ 274 85 1607 ◇

◇ = W

FIXED

INCL. 1 x PC SBL

INCL. LED CLUSTER 6,5W / 3000K ● / 670lm

INCL. LED POWER SUPPLY 350mA-DC

100-240V / 50-60Hz

CE 0,5 IP40

REQUIREMENT FOR RECESSED INSTALLATION

PITCH 162 RECESSED KIT

274 88 014



PITCH 162 + PITCH 260

The Lighting Bible 10 INT 281

The Lighting Bible 10 / Product Catalog INT 179



BOOSTER HP + SOFTENING LENS 87



HONEYCOMB 87

LINEAR SPREAD LENS 87

SPREAD LENS 87

SOFTENING LENS 87

GLASS SBL 87

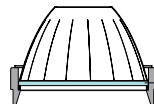

POSITION OF ACCESSORY

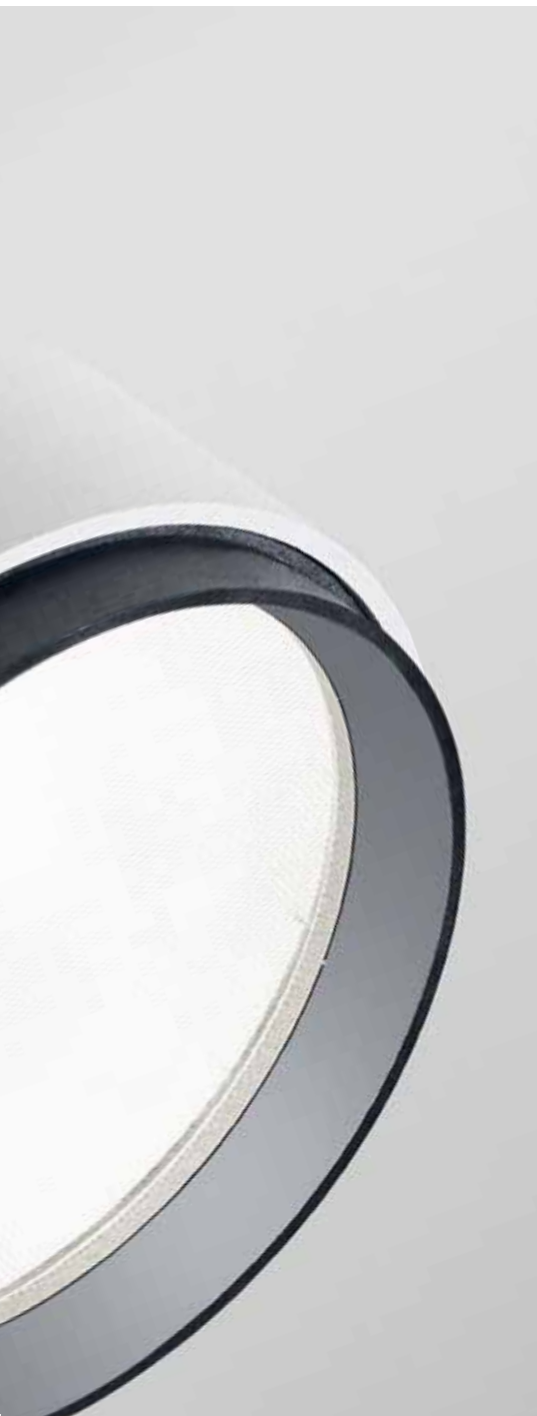

FULL INFO / PAG 132

Accessories

HONEYCOMB 87 ◇

201 01 01 ◇

◇ = B

LINEAR SPREAD LENS 87

201 01 02

SPREAD LENS 87

201 01 03

SOFTENING LENS 87

201 01 04

GLASS SBL 87

201 01 05



Booster HP



up to
90%
efficiency

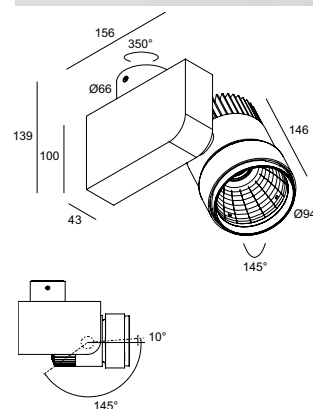

CRI > 80

3000K ●

3000 lm

REFLECTOR FL-27°

BOOSTER HP 3027 ◇

313 23 48122 ◇

◇ = B / W

REFLECTOR WFL-50°

BOOSTER HP 3050 ◇

313 23 48132 ◇

◇ = B / W

ADJUSTABLE 145° / 350°
INCL. 1 x POWERLED WHITE 29W
INCL. LED POWER SUPPLY 600mA-DC
220-240V / 50-60Hz

◇ CE 2,1 IP20

ACCESSORIES
HONEYCOMB 87
LINEAR SPREAD LENS 87
SPREAD LENS 87
SOFTENING LENS 87
GLASS SBL 87

ON REQUEST CRI>90



FULL INFO / PAG TEC

Options

INSTALLATION

CABLE BASE R ◇ Ø57 x 41

203 99 55 ◇
◇ = ANO / W / B



CABLE BASE S ◇ 57 x 57 x 41

203 99 56 ◇
◇ = ANO / W / B



COVERSET R

204 00 62 ◇ Ø62

204 00 90 ◇ Ø90

204 00 100 ◇ Ø100

◇ = ANO / B / W



COVERSET S

204 62 62 ◇ 62 x 62

204 80 80 ◇ 80 x 80

204 90 90 ◇ 90 x 90

◇ = ANO / B / W



Superdome

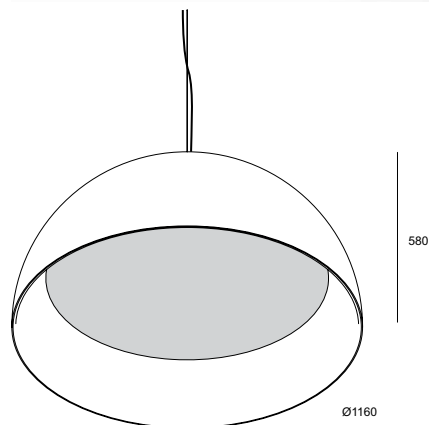

SUPERDOME 9528 EVG DIM1 ◇

321 95 9528 ED1 ◇

◇ = B-W / W-W

INCL.PC SBL

INCL. 1 x CABLE SUSP. SINGLE AUTO. 3m

INCL. 1 x CABLE 5 x 0,75mm² 3m

INCL.LEDCLUSTER 114W / 3000K / 9825 lm

INCL.2 x LED POWER SUPPLY 350mA-DC

DIMMING BY 1-10V

120-240V / 50-60Hz

◇ CE IP20

OPTIONS

CABLE BASE R / S

COVERSET R 62-90-100 / S 62-80-90

SUPERDOME ◇

321 95 327 ◇

◇ = B-W / W-W

INCL.PC SBL

INCL. 1 x CABLE SUSP. SINGLE AUTO. 3m

INCL. 1 x CABLE 3 x 0,75mm² 3m

E27Ls / 100-240V / 50-60Hz

3 x TC-TSE max.23W

3 x TCA-SE max.23W

◇ CE IP20

OPTIONS

CABLE BASE R / S

COVERSET R 62-90-100 / S 62-80-90

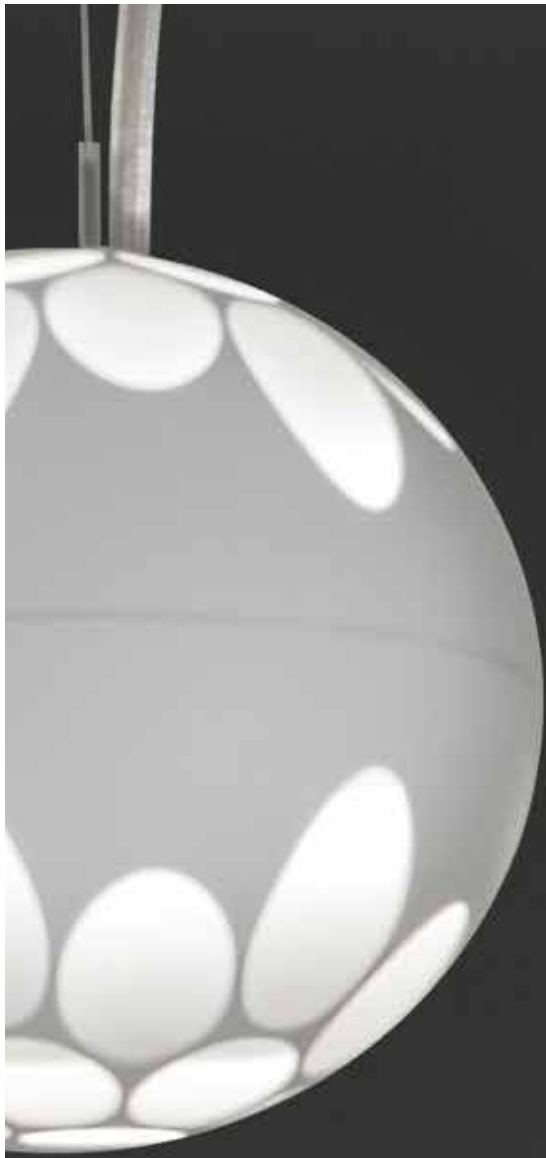

FULL INFO / PAG 130

Options

INSTALLATION

SUSPENSION + CONNECTION TRIMLESS O.F.A.

328 10 02

INCL.1 x AUTOMATIC ADJUSTMENT

INCL.1 x CONNECTOR 3 x 2.5mm²

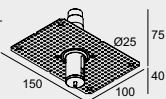

SUSPENSION + CONNECTION TRIMLESS



Gaboo C



GABOO C ◇

286 64 12 ◇

◇ = B / W

INCL.1 x LED CLUSTER UP 6,3W / 3000K ● / 725lm

INCL.1 x LED CLUSTER DOWN 7,3W / 3000K ● / 845lm

INCL.DIMMABLE LED POWER SUPPLY 350mA-DC

MAINS DIMMING (FE)

INCL.1 x CABLE 2 x 0.75mm²

INCL.1 x CABLE SUSP. SINGLE AUTO 1,6m

100-240V / 50-60Hz

◇ IP20

OPTIONS

SUSPENSION + CONNECTION TRIMLESS



Gaboo W

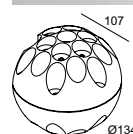
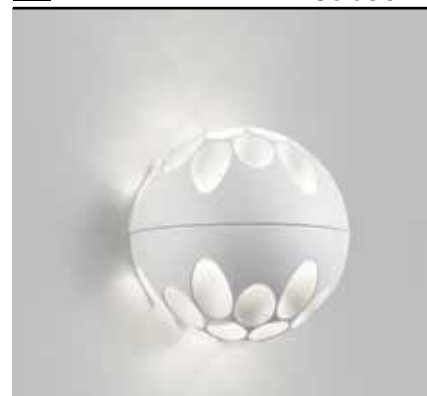

GABOO W ◇

286 64 22 ◇

◇ = W

INCL.1 x LED CLUSTER UP 6,3W / 3000K ● / 725lm

INCL.1 x LED CLUSTER DOWN 6,3W / 3000K ● / 725lm

INCL.DIMMABLE LED POWER SUPPLY 350mA-DC

MAINS DIMMING (FE)

100-240V / 50-60Hz

IP20





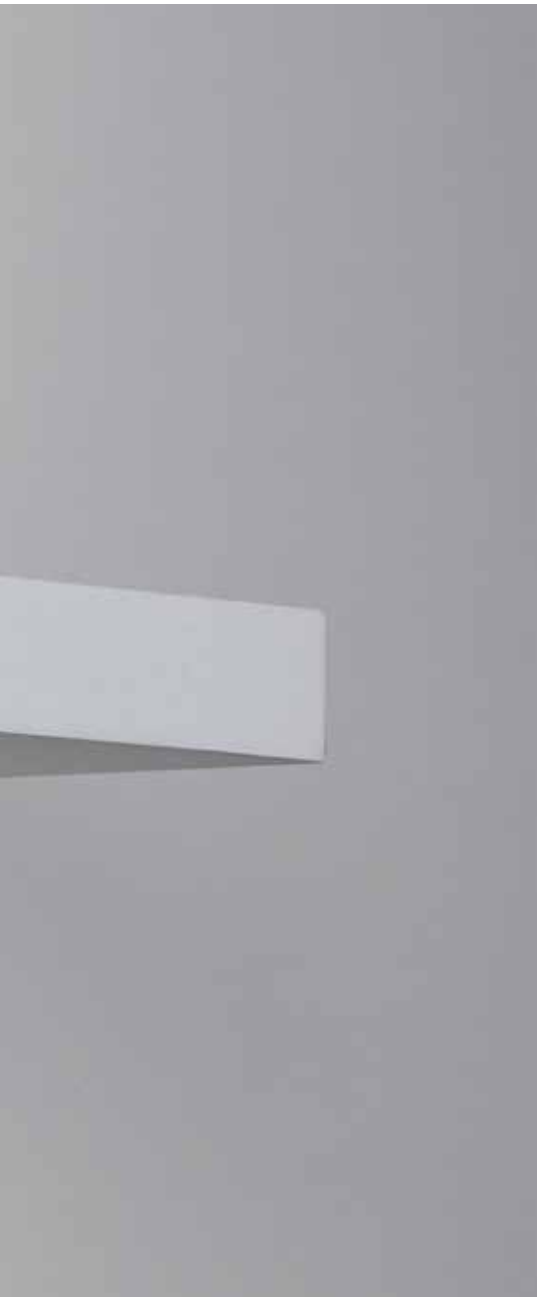

Pogo

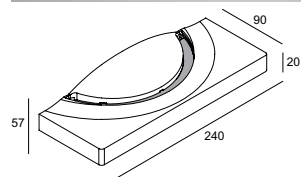

POGO ◇
278 72 22 ◇
 ◇ = W

INCL. 1 x LED CLUSTER UP 5,4W / 3000K ● / 605lm
 INCL. 1 x LED CLUSTER DOWN 5,4W / 3000K ● / 605lm
 INCL. 2 x PC
 INCL. DIMMABLE LED POWER SUPPLY 250mA-DC
 MAINS DIMMING (FE)
 100-240V / 50-60Hz

□ CE 0.7 IP40

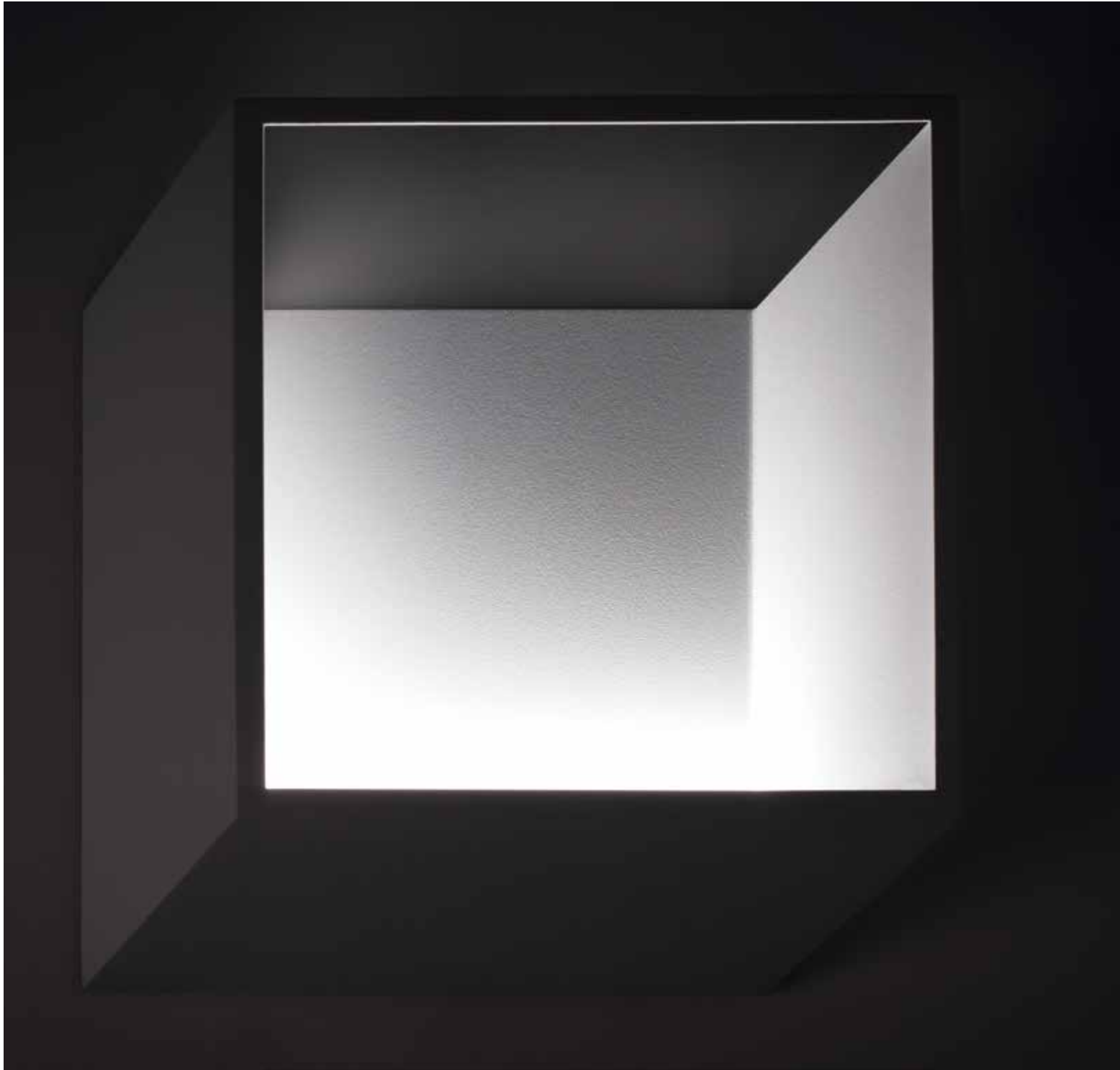



Forty-5

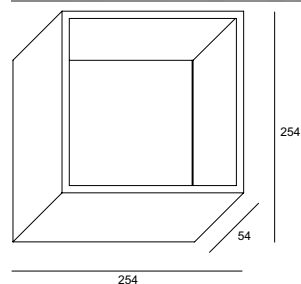
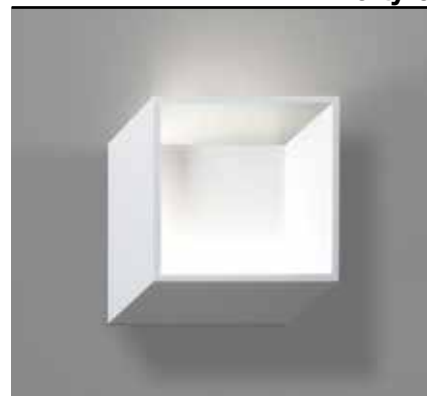

FORTY-5 WW L ◇
278 71 12 L ◇

◇ = W

INCL. 1 x LED CLUSTER 6,3W / 3000K ● / 725lm
INCL. LED POWER SUPPLY 350mA-DC
220-240V / 50-60Hz

□ CE 2.7 IP20

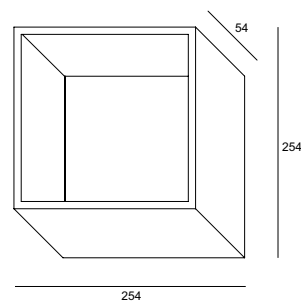

FORTY-5 WW R ◇
278 71 12 R ◇

◇ = W

INCL. 1 x LED CLUSTER 6,3W / 3000K ● / 725lm
INCL. LED POWER SUPPLY 350mA-DC
220-240V / 50-60Hz

□ CE 2.7 IP20





Backspace LED

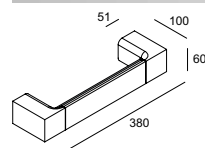

BACKSPACE 38 LED ◇

274 81 12 ◇

◇ = W / B

INCL. 1 x LEDCLUSTER 7,5W / 3000K ● / 845lm
 INCL. DIMMABLE LED POWER SUPPLY 350mA-DC
 MAINS DIMMING (FE)
 100-240 / 50-60Hz

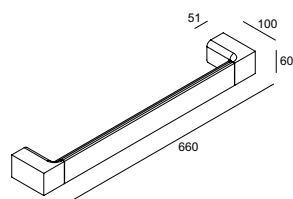
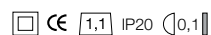

BACKSPACE 66 LED ◇

274 81 22 ◇

◇ = W / B

INCL. 1 x LEDCLUSTER 15W / 3000K ● / 1690lm
 INCL. DIMMABLE LED POWER SUPPLY 350mA-DC
 MAINS DIMMING (FE)
 100-240 / 50-60Hz

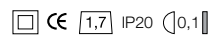

Composition

- 1 TRACK DIM
- 2 ENDCAP / SUPPLY / CORNERS
- 3 FIXATION
- 4 CURRENT SUPPLY
- 5 OPTIONS

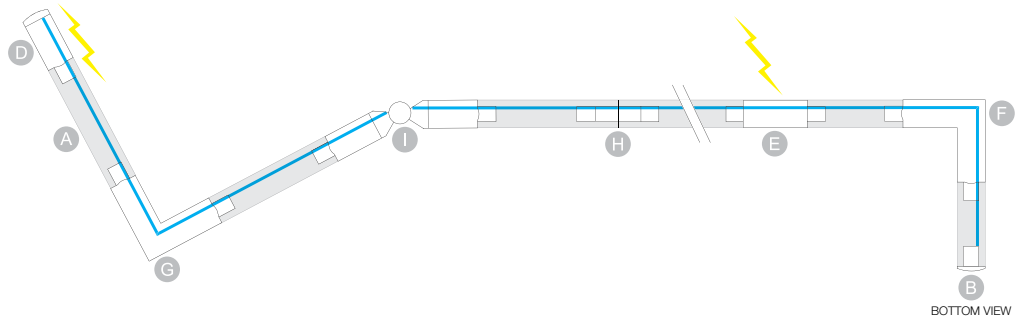

1 Track Dim

	TRACK DIM 1m ◇	TRACK DIM 2m ◇	TRACK DIM 3m ◇
200 11 410 ◇	◇ = ANO / B / W	◇ = ANO / B / W	◇ = ANO / B / W
110-240V / 50-60Hz / 3F	110-240V / 50-60Hz / 3F	110-240V / 50-60Hz / 3F	110-240V / 50-60Hz / 3F
◇ CE IP20	◇ CE IP20	◇ CE IP20	
0,8	1,6	2,4	

2 Endcap / Supply / Corners

TRACK DIM END CAP ◇ 200 11 41 ◇ ◇ = A / B / W CE 0,1
TRACK DIM END SUPPLY 11 ◇ 200 11 11 ◇ ◇ = A / B / W 220-240V / 50-60Hz ◇ CE 0,1 IP20
TRACK DIM END SUPPLY 12 ◇ 200 11 12 ◇ ◇ = A / B / W 220-240V / 50-60Hz ◇ CE 0,1 IP20
TRACK DIM MIDDLE SUPPLY ◇ 200 11 14 ◇ ◇ = A / B / W 220-240V / 50-60Hz ◇ CE 0,1 IP20
TRACK DIM CORNER 90° OUT ◇ 200 11 35 ◇ ◇ = A / B / W ◇ CE 0,1 IP20
TRACK DIM CORNER 90° IN ◇ 200 11 34 ◇ ◇ = A / B / W ◇ CE 0,1 IP20
TRACK DIM CORNER 180° ◇ 200 11 21 ◇ ◇ = A / B / W ◇ CE 0,1 IP20
TRACK DIM CORNER 60°-300° ◇ 200 11 24 ◇ ◇ = A / B / W ◇ CE 0,1 IP20

3 Fixation

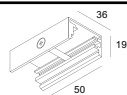
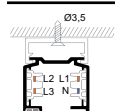

TRACK DIM DIRECT FIXATION ◇

200 11 02 ◇

◇ = ANO

0,1

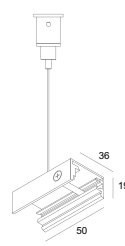
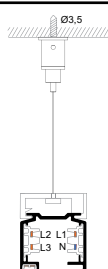

TRACK DIM SUSPENSION 3,0

200 11 13

L 3,0m

0,1

4 Current Supply

TRACK CURRENT SUPPLY 5 x 0,75mm² 3,0m

200 99 53

L 3,0m / 5 x 0,75mm²

0,3

OPTIONS

CABLE BASE R/S



5 Options FULL INFO / PAG TEC

INSTALLATION		
CABLE BASE R ◇	Ø57 x 41	
203 99 55 ◇		
◇ = ANO / W / B		
CABLE BASE S ◇	57 x 57 x 41	
203 99 56 ◇		
◇ = ANO / W / B		
COVERSET R ◇		
204 00 62 ◇	Ø62	
204 00 90 ◇	Ø90	
204 00 100 ◇	Ø100	
◇ = ANO / B / W		
COVERSET S ◇		
204 62 62 ◇	62 x 62	
204 80 80 ◇	80 x 80	
204 90 90 ◇	90 x 90	
◇ = ANO / B / W		



4000K ●

3000K ●

REFLECTOR FL-33°

REFLECTOR WFL-50°

2700K ●

REFLECTOR FL-33°

REFLECTOR WFL-50°

Delta'11
Awards
△
Silver
Delta



reddot design award
winner 2012

GOOD
DESIGN
award





You-Turn On Reo AD DIM

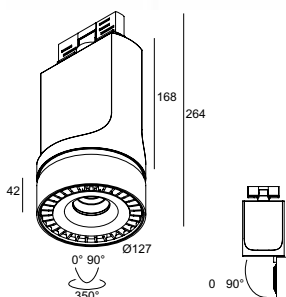

CRI > 80	CRI > 90
ON REQUEST	
2130 lm	1750 lm
YOU-TURN ON REO 203033 AD DIM1 ◇ 313 020 20122 AD ED1 ◇ ◇ = W-B	YOU-TURN ON REO 203033-9 AD DIM1 ◇ 313 020 209122 AD ED1 ◇ ◇ = W-B
YOU-TURN ON REO 203050 AD DIM1 ◇ 313 020 20132 AD ED1 ◇ ◇ = W-B	YOU-TURN ON REO 203050-9 AD DIM1 ◇ 313 020 209132 AD ED1 ◇ ◇ = W-B
1990 lm	1735 lm
YOU-TURN ON REO 202733 AD DIM1 ◇ 313 020 20123 AD ED1 ◇ ◇ = W-B	YOU-TURN ON REO 202733-9 AD DIM1 ◇ 313 020 209123 AD ED1 ◇ ◇ = W-B
YOU-TURN ON REO 202750 AD DIM1 ◇ 313 020 20133 AD ED1 ◇ ◇ = W-B	YOU-TURN ON REO 202750-9 AD DIM1 ◇ 313 020 209133 AD ED1 ◇ ◇ = W-B

ADJUSTABLE 0°- 90° / 350°
INCL. 1 x 3F MULTI ADAPTOR
INCL. 1 x POWERLED WHITE 25W
INCL. DIMMABLE LED POWER SUPPLY 700mA-DC
DIMMING BY 1-10V
110-240V / 50-60Hz

◇ CE 1.6 IP20

CRI > 80	CRI > 90
ON REQUEST	
2130 lm	1750 lm
YOU-TURN ON REO 203033 AD DIM5 ◇ 313 020 20122 AD ED5 ◇ ◇ = W-B	YOU-TURN ON REO 203033-9 AD DIM5 ◇ 313 020 209122 AD ED5 ◇ ◇ = W-B
YOU-TURN ON REO 203050 AD DIM5 ◇ 313 020 20132 AD ED5 ◇ ◇ = W-B	YOU-TURN ON REO 203050-9 AD DIM5 ◇ 313 020 209132 AD ED5 ◇ ◇ = W-B
1990 lm	1735 lm
YOU-TURN ON REO 202733 AD DIM5 ◇ 313 020 20123 AD ED5 ◇ ◇ = W-B	YOU-TURN ON REO 202733-9 AD DIM5 ◇ 313 020 209123 AD ED5 ◇ ◇ = W-B
YOU-TURN ON REO 202750 AD DIM5 ◇ 313 020 20133 AD ED5 ◇ ◇ = W-B	YOU-TURN ON REO 202750-9 AD DIM5 ◇ 313 020 209133 AD ED5 ◇ ◇ = W-B

ADJUSTABLE 0°- 90° / 350°
INCL. 1 x 3F MULTI ADAPTOR
INCL. 1 x POWERLED WHITE 25W
INCL. DIMMABLE LED POWER SUPPLY 700mA-DC
DIMMING BY DALI
110-240V / 50-60Hz

◇ CE 1.6 IP20



FULL INFO / PAG 131

Accessories

OPTO CLIP ◇

201 02 00 ◇
◇ = B

HONEYCOMB 78 ◇

201 02 01 ◇
◇ = B

SOFTENING LENS 78

201 02 04

4000K ●

3000K ●

REFLECTOR SP-15°

REFLECTOR FL-33°

REFLECTOR WFL-55°

2700K ●

REFLECTOR SP-15°

REFLECTOR FL-33°

REFLECTOR WFL-55°

Delta'11
Awards
△
Silver
Delta



reddot design award
winner 2012

GOOD
DESIGN
award



OPTO CLIP 78



HONEYCOMB 78



SOFTENING LENS 78



You-Turn On Opto AD DIM

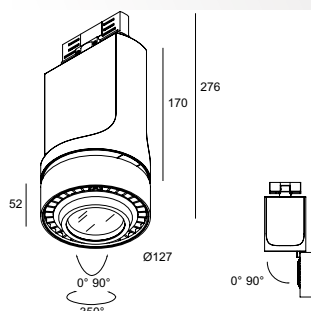

CRI > 80	CRI > 90
ON REQUEST	
2130 lm	1750 lm
YOU-TURN ON OPTO 203015 AD DIM1 ◇ 313 021 20112 AD ED1 ◇ ◇ = B-B / W-B	YOU-TURN ON OPTO 203015-9 AD DIM1 ◇ 313 021 209112 AD ED1 ◇ ◇ = B-B / W-B
YOU-TURN ON OPTO 203033 AD DIM1 ◇ 313 021 20122 AD ED1 ◇ ◇ = B-B / W-B	YOU-TURN ON OPTO 203033-9 AD DIM1 ◇ 313 021 209122 AD ED1 ◇ ◇ = B-B / W-B
YOU-TURN ON OPTO 203055 AD DIM1 ◇ 313 021 20132 AD ED1 ◇ ◇ = B-B / W-B	YOU-TURN ON OPTO 203055-9 AD DIM1 ◇ 313 021 209132 AD ED1 ◇ ◇ = B-B / W-B
1990 lm	1735 lm
YOU-TURN ON OPTO 202715 AD DIM1 ◇ 313 021 20113 AD ED1 ◇ ◇ = B-B / W-B	YOU-TURN ON OPTO 202715-9 AD DIM1 ◇ 313 021 209113 AD ED1 ◇ ◇ = B-B / W-B
YOU-TURN ON OPTO 202733 AD DIM1 ◇ 313 021 20123 AD ED1 ◇ ◇ = B-B / W-B	YOU-TURN ON OPTO 202733-9 AD DIM1 ◇ 313 021 209123 AD ED1 ◇ ◇ = B-B / W-B
YOU-TURN ON OPTO 202755 AD DIM1 ◇ 313 021 20133 AD ED1 ◇ ◇ = B-B / W-B	YOU-TURN ON OPTO 202755-9 AD DIM1 ◇ 313 021 209133 AD ED1 ◇ ◇ = B-B / W-B

ADJUSTABLE 0°- 90° / 350°
INCL. 1 x 3F MULTI ADAPTOR
INCL. 1 x POWERLED WHITE 25W
INCL. 1 x EFT FILTER*
INCL. DIMMABLE LED POWER SUPPLY 700mA-DC
DIMMING BY 1-10V
110-240V / 50-60Hz

◇ CE 1.7 IP20

ACCESSORIES
OPTO CLIP
HONEYCOMB 78
SOFTENING LENS 78



CRI > 80	CRI > 90
ON REQUEST	
2130 lm	1750 lm
YOU-TURN ON OPTO 203015 AD DIM5 ◇ 313 021 20112 AD ED5 ◇ ◇ = B-B / W-B	YOU-TURN ON OPTO 203015-9 AD DIM5 ◇ 313 021 209112 AD ED5 ◇ ◇ = B-B / W-B
YOU-TURN ON OPTO 203033 AD DIM5 ◇ 313 021 20122 AD ED5 ◇ ◇ = B-B / W-B	YOU-TURN ON OPTO 203033-9 AD DIM5 ◇ 313 021 209122 AD ED5 ◇ ◇ = B-B / W-B
YOU-TURN ON OPTO 203055 AD DIM5 ◇ 313 021 20132 AD ED5 ◇ ◇ = B-B / W-B	YOU-TURN ON OPTO 203055-9 AD DIM5 ◇ 313 021 209132 AD ED5 ◇ ◇ = B-B / W-B
1990 lm	1735 lm
YOU-TURN ON OPTO 202715 AD DIM5 ◇ 313 021 20113 AD ED5 ◇ ◇ = B-B / W-B	YOU-TURN ON OPTO 202715-9 AD DIM5 ◇ 313 021 209113 AD ED5 ◇ ◇ = B-B / W-B
YOU-TURN ON OPTO 202733 AD DIM5 ◇ 313 021 20123 AD ED5 ◇ ◇ = B-B / W-B	YOU-TURN ON OPTO 202733-9 AD DIM5 ◇ 313 021 209123 AD ED5 ◇ ◇ = B-B / W-B
YOU-TURN ON OPTO 202755 AD DIM5 ◇ 313 021 20133 AD ED5 ◇ ◇ = B-B / W-B	YOU-TURN ON OPTO 202755-9 AD DIM5 ◇ 313 021 209133 AD ED5 ◇ ◇ = B-B / W-B

ADJUSTABLE 0°- 90° / 350°
INCL. 1 x 3F MULTI ADAPTOR
INCL. 1 x POWERLED WHITE 25W
INCL. 1 x EFT FILTER*
INCL. DIMMABLE LED POWER SUPPLY 700mA-DC
DIMMING BY DALI
110-240V / 50-60Hz

◇ CE 1.7 IP20

ACCESSORIES
OPTO CLIP
HONEYCOMB 78
SOFTENING LENS 78

*EFT / EQUALISING FILTER TECHNOLOGY



BOOSTER HP AD + SOFTENING LENS 87



HONEYCOMB 87

LINEAR SPREAD LENS 87

SPREAD LENS 87

SOFTENING LENS 87

GLASS SBL 87

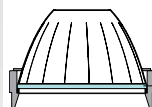

POSITION OF ACCESSORY

FULL INFO / PAG 132

Accessories

HONEYCOMB 87 ◊
201 01 01 ◊
◊ = B

LINEAR SPREAD LENS 87
201 01 02

SPREAD LENS 87
201 01 03

SOFTENING LENS 87
201 01 04

GLASS SBL 87
201 01 05



Booster HP AD

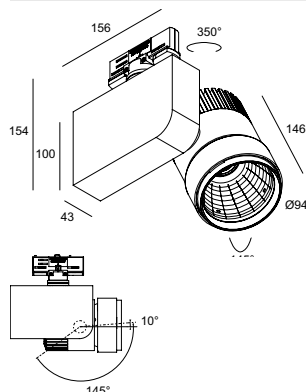

up to
90%
efficiency



Booster HP AD DIM

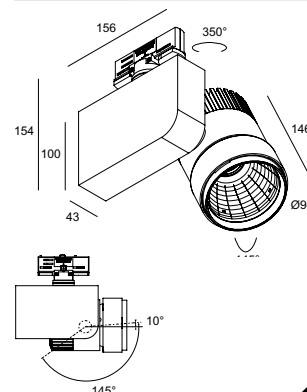

up to
90%
efficiency



CRI > 80

3000K

3000 lm

REFLECTOR FL-27°

BOOSTER HP 3027 AD ◊
313 23 48122 AD ◊
◊ = B / W

REFLECTOR WFL-50°

BOOSTER HP 3050 AD ◊
313 23 48132 AD ◊
◊ = B / W

ADJUSTABLE 145° / 350°
INCL. 1 x POWERLED WHITE 29W
INCL. LED POWER SUPPLY 600mA-DC
220-240V / 50-60Hz

◊ CE 2.1 IP20

ACCESSORIES
HONEYCOMB 87
LINEAR SPREAD LENS 87
SPREAD LENS 87
SOFTENING LENS 87
GLASS SBL 87

CRI > 80

3000 lm

BOOSTER HP 3027 AD DIM5 ◊
313 23 48122 AD ED5 ◊
◊ = B / W

BOOSTER HP 3050 AD DIM5 ◊
313 23 48132 AD ED5 ◊
◊ = B / W

ADJUSTABLE 145° / 350°
INCL. 1 x POWERLED WHITE 29W
INCL. LED POWER SUPPLY 600mA-DC
DIMMING BY DALI
220-240V / 50-60Hz

◊ CE 2.1 IP20

ACCESSORIES
HONEYCOMB 87
LINEAR SPREAD LENS 87
SPREAD LENS 87
SOFTENING LENS 87
GLASS SBL 87

ON REQUEST CRI>90

ON REQUEST CRI>90





DESIGN PLUS 2014



**Supernova XS
Pivot AD DIM**

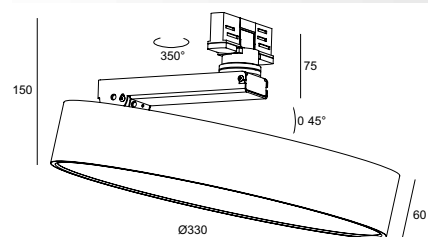

SUPERNOVA XS PIVOT 330 AD DIM1 ◇
274 88 3224 AD ED1 ◇

◇ = W
INCL.1 x PC SBL
INCL.LED CLUSTER 25W / 3000K ● / 2155lm
INCL.LED POWER SUPPLY 1050mA-DC
DIMMING BY 1-10V
110-240V / 50-60Hz

◇ CE 1.4 IP40 (0,1)



SUPERNOVA XS PIVOT 330 AD DIM5 ◇
274 88 3224 AD ED5 ◇

◇ = W
INCL.1 x PC SBL
INCL.LED CLUSTER 25W / 3000K ● / 2155lm
INCL.LED POWER SUPPLY 1050mA-DC
DIMMING BY DALI
110-240V / 50-60Hz

◇ CE 1.4 IP40 (0,1)

PROFILES

Production of made-to-measure profile systems has become a vital and distinctive element of Delta Light®'s collection.

The profile range includes various dimensions, diverse styles, different lamps and light modules, dimming and supply solutions, and a large number of accessories and combination options. Suspended, recessed or surface mounted, either for wall, floor or ceiling, interior and exterior, Delta Light® is your one-stop supplier for all profile lighting systems.

The following range completes the Lighting Bible® 10 profile collection.





FINNLINE

The Finnlite is an extremely thin and versatile made-to-measure profile solution. Used either as a down, up or down-up lighting profile, the Finnlite caters for a very wide range of applications. Despite its extremely slim design, the Finnlite allows you to make surprising combinations, using Delta Light's unique Tweeter and Mini Spy, a graphic combination of thin led lines, or as a fully functional and efficient led profile.



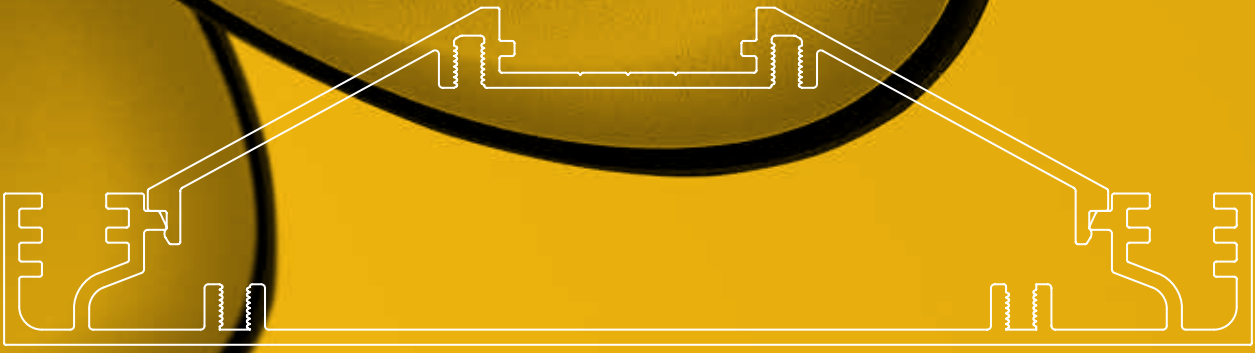
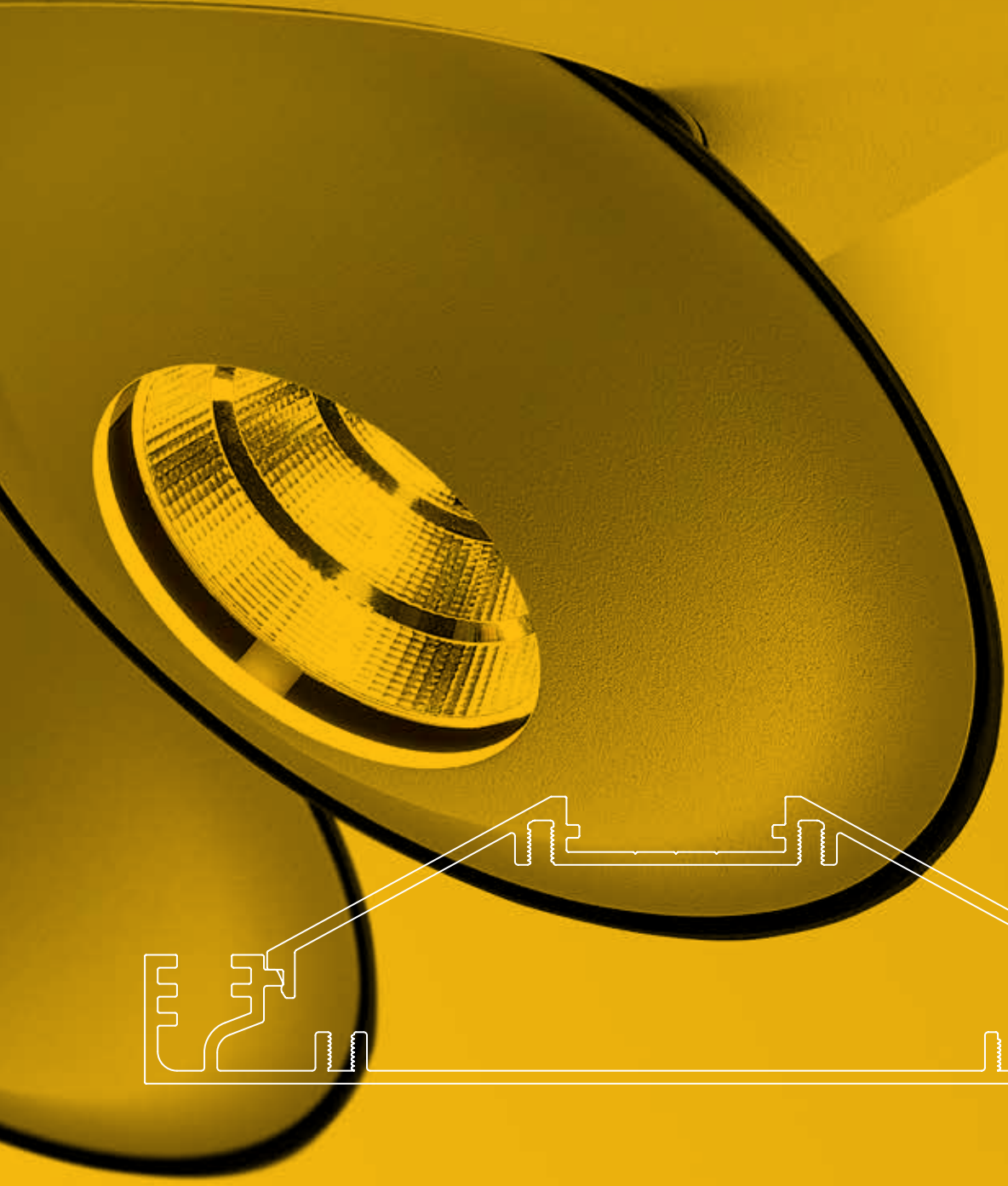



Finline

PROFILE

FNL - PROFILE ◇
390 00 00 ◇
 ◇ = B / W
 MAX.L / PROFILE : 6m
 Kg / m
1,6

TOL EN12020-2

END CAP

FNL - END CAP ◇
390 03 01 ◇
 ◇ = B-C / W-C
0,1

CORNER

FNL - CONNECTION 180°
390 06 01
0,3

FNL - CONNECTION 90°
390 06 06
0,3

FIXATION

SUSPENSION 7 SINGLE 1,6
328 18 01
 L 1,6m

SUSPENSION 7 SINGLE 6,0
328 18 06
 L 6m
0,1

CURRENT SUPPLY

CURRENT SUPPLY
 L 1,6m / 3 x 0,75mm² **390 98 51**
 L 6,0m / 3 x 0,75mm² **390 98 56**
 L 1,6m / 5 x 0,75mm² **390 99 51**
 L 6,0m / 5 x 0,75mm² **390 99 56** 0,3

OPTIONS
 CABLE BASE R/S
 COVERSET R 62-90-100 / S 62-80-90

203 99 55 ◇
 ◇ = ANO / B / W

203 99 56 ◇
 ◇ = ANO / B / W
0,1

NO MODULE IN THIS AREA
 UP 350mm
 DOWN 120mm

4000K ●

3000K ●

REFLECTOR FL-33°

REFLECTOR WFL-50°

2700K ●

REFLECTOR FL-33°

REFLECTOR WFL-50°

ACCESSORIES / FULL INFO PAG 134





Finnline 1 Tweeter



L 220 PATENTED EX-CENTRIC ROTATION SYSTEM®



CRI > 80	CRI > 90
ON REQUEST	
920 lm	810 lm
FNL - 1 TWEETER 3033 ◇ 390 61 8122 ◇ ◇ = B / W	FNL - 1 TWEETER 3033-9 ◇ 390 61 89122 ◇ ◇ = B / W
FNL - 1 TWEETER 3050 ◇ 390 61 8132 ◇ ◇ = B / W	FNL - 1 TWEETER 3050-9 ◇ 390 61 89132 ◇ ◇ = B / W
865 lm	735 lm
FNL - 1 TWEETER 2733 ◇ 390 61 8123 ◇ ◇ = B / W	FNL - 1 TWEETER 2733-9 ◇ 390 61 89123 ◇ ◇ = B / W
FNL - 1 TWEETER 2750 ◇ 390 61 8133 ◇ ◇ = B / W	FNL - 1 TWEETER 2750-9 ◇ 390 61 89133 ◇ ◇ = B / W
ADJUSTABLE 0°-45° / 350° INCL.1 x POWERLED WHITE 10W INCL.LED POWER SUPPLY 500mA-DC 110-240V / 50-60Hz ◇ CE [0,3] IP20 ACCESSORIES / FULL INFO PAG 134	



Finnline 2 Tweeter



L 480 PATENTED EX-CENTRIC ROTATION SYSTEM®

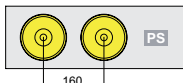

CRI > 80	CRI > 90
ON REQUEST	
2x 920 lm	2x 810 lm
FNL - 2 TWEETER 3033 ◇ 390 61 8222 ◇ ◇ = B / W	FNL - 2 TWEETER 3033-9 ◇ 390 61 89222 ◇ ◇ = B / W
FNL - 2 TWEETER 3050 ◇ 390 61 8232 ◇ ◇ = B / W	FNL - 2 TWEETER 3050-9 ◇ 390 61 89232 ◇ ◇ = B / W
2x 620 lm	2x 525 lm
FNL - 2 TWEETER 2733 ◇ 390 61 8223 ◇ ◇ = B / W	FNL - 2 TWEETER 2733-9 ◇ 390 61 89223 ◇ ◇ = B / W
FNL - 2 TWEETER 2750 ◇ 390 61 8233 ◇ ◇ = B / W	FNL - 2 TWEETER 2750-9 ◇ 390 61 89233 ◇ ◇ = B / W
ADJUSTABLE 0°-45° / 350° INCL.2 x POWERLED WHITE 10W INCL.LED POWER SUPPLY 500mA-DC 220-240V / 50-60Hz ◇ CE [0,4] IP20 ACCESSORIES / FULL INFO PAG 134	



Finnline Mini Spy

FNL - MINI SPY 2 LEFT ◇
390 61 22 L ◇
◇ = B / W
INCL.2 x POWERLED WHITE 2W / 3000K ●
INCL.2 x LENS 19°
INCL.LED POWER SUPPLY 500mA-DC
110-240V / 50-60Hz
◇ CE [0,3] IP20

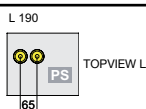

FNL - MINI SPY 2 RIGHT ◇
390 61 22 R ◇
◇ = B / W
INCL.2 x POWERLED WHITE 2W / 3000K ●
INCL.2 x LENS 19°
INCL.LED POWER SUPPLY 500mA-DC
110-240V / 50-60Hz
◇ CE [0,3] IP20

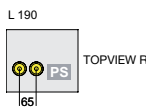

PATENTED EX-CENTRIC ROTATION SYSTEM®



Finnline Mini Spy A

FNL - MINI SPY 3 ASYMMETRIC LEFT ◇
390 61 32 AL ◇
◇ = B / W
INCL.3 x POWERLED WHITE 2W / 3000K ●
INCL.3 x LENS 19°
INCL.LED POWER SUPPLY 500mA-DC
110-240V / 50-60Hz
◇ CE [0,3] IP20

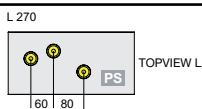

FNL - MINI SPY 3 ASYMMETRIC RIGHT ◇
390 61 32 AR ◇
◇ = B / W
INCL.3 x POWERLED WHITE 2W / 3000K ●
INCL.3 x LENS 19°
INCL.LED POWER SUPPLY 500mA-DC
110-240V / 50-60Hz
◇ CE [0,3] IP20

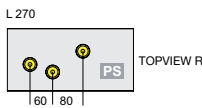

PATENTED EX-CENTRIC ROTATION SYSTEM®





Finline Led Array Up

FNL - LED ARRAY UP
 INCL.FNL - PC SBL PROFILE UP
 INCL.POWER SUPPLY
 INCL.LED STRIP UP 500mm - 3000K - 10W/strip - 1260lm/m - 63lm/W
 220-240V / 50-60Hz

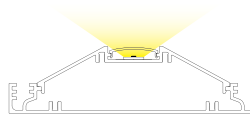

CE 1.6 IP20 0,1

Watt	L (mm)	EVG	EVG	EVG
			DIM 1-10V	DIM DALI SWITCH
2 x 10	1000	390 620 22 E		
4 x 10	2000	390 620 42 E		
6 x 10	3000	390 620 62 E		



Finline Led Array Down Finn

FNL - LED ARRAY DOWN FINN
 INCL.FNL - PC SBL PROFILE DOWN
 INCL.POWER SUPPLY
 INCL.LED ARRAY DOWN 560mm - 3000K - 15W/array - 3214lm/m - 120lm/W
 220-240V / 50-60Hz

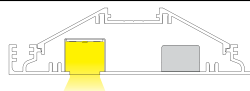

CE 1.6 IP20 0,1

Watt	L (mm)	X (mm)	EVG	EVG	EVG
				DIM 1-10V	DIM DALI SWITCH
2 x (1x15W)	1180	100	390 611 22 L E	390 611 22 L ED1	390 611 22 L ED2
2 x (2x15W)	1980	420	390 611 42 L E	390 611 42 L ED1	390 611 42 L ED2
2 x (3x15W)	2980	540	390 611 62 L E	390 611 62 L ED1	390 611 62 L ED2
2 x (1x15W)	1180	100	390 611 22 R E	390 611 22 R ED1	390 611 22 R ED2
2 x (2x15W)	1980	420	390 611 42 R E	390 611 42 R ED1	390 611 42 R ED2
2 x (3x15W)	2980	540	390 611 62 R E	390 611 62 R ED1	390 611 62 R ED2

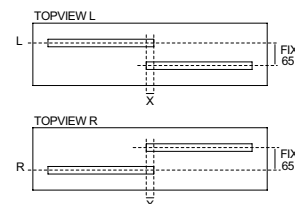



Finnline Ready-Made

PROFILE



FNL - PROFILE READY-MADE

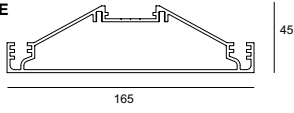

TOL EN12020-2

END CAP

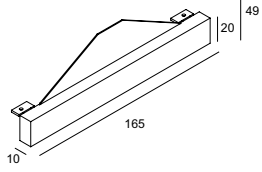
FNL - END CAP ◇
390 03 01 ◇
 ◇ = B-C / W-C

0,1

CORNER

FNL - CONNECTION SET RM 180°
390 06 018

0,3

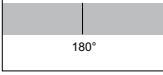

FIXATION

SUSPENSION 7 SINGLE 1,6
328 18 01
 L 1,6m

SUSPENSION 7 SINGLE 6,0
328 18 06
 L 6m

0,1

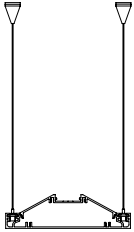

CURRENT SUPPLY

CURRENT SUPPLY
 L 1,6m / 3 x 0,75mm² **390 98 51**
 L 6,0m / 3 x 0,75mm² **390 98 56**
 L 1,6m / 5 x 0,75mm² **390 99 51**
 L 6,0m / 5 x 0,75mm² **390 99 56** 0,3

OPTIONS
 CABLE BASE R/S
 COVERSET R 62-90-100 / S 62-80-90

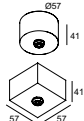

203 99 55 ◇
 ◇ = ANO / B / W

203 99 56 ◇
 ◇ = ANO / B / W

0,1



Finnacle Ready-Made Led Array Down

FNL - RM LED ARRAY DOWN

INCL.1 x FNL - PROFILE
 INCL.FNL - PC SBL PROFILE DOWN
 INCL.LED ARRAY DOWN 560mm - 3000K - 15W/array - 3214lm/m - 120lm/W
 INCL.POWER SUPPLY
 220-240V / 50-60Hz

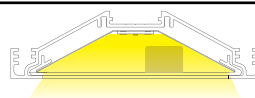

IP20 (0,1)

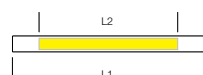

Watt	L1 (mm)	L2 (mm)	EVG ■	EVG ■	EVG ■
2 x 15W	1880	1100		DIM 1-10V	DIM DALI SWITCH
3 x 15W	2440	1660			
4 x 15W	3000	2220			

390 518 42 E ◇ 390 518 42 ED1 ◇ 390 518 42 ED2 ◇
 390 518 62 E ◇ 390 518 62 ED2 ◇
 390 518 82 E ◇ 390 518 82 ED2 ◇

◇ = B / W ◇ = B / W ◇ = B / W

Finnacle Ready-Made Led Array Down-Up

FNL - RM LED ARRAY DOWN-UP

INCL.1 x FNL - PROFILE
 INCL.FNL - PC SBL PROFILE DOWN
 INCL.LED ARRAY DOWN 560mm - 3000K - 15W/array - 3214lm/m - 120lm/W
 INCL.POWER SUPPLY
 INCL.LEDSTRIP UP 500mm - 3000K - 10W/STRIP - 63lm/W
 INCL.PC CLEAR UP
 INCL.POWER SUPPLY 24V-DC
 220-240V / 50-60Hz / 2 CIRCUITS

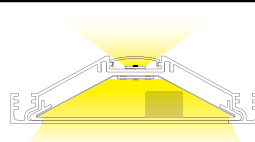

IP20 (0,1)

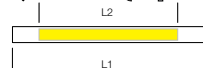

Watt	L1 (mm)	L2 (mm)	EVG ■	EVG ■	EVG ■
2 x 15W DWN + 3x10 UP	1880	1100		DIM 1-10V	DIM DALI SWITCH
3 x 15W DWN + 4x10 UP	2440	1660			
4 x 15W DWN + 5x10 UP	3000	2220			

390 538 42 32 E ◇ 390 538 42 32 ED1 ◇ 390 538 42 32 ED2 ◇
 390 538 62 42 E ◇ 390 538 62 42 ED2 ◇
 390 538 82 52 E ◇ 390 538 82 52 ED2 ◇

◇ = B / W ◇ = B / W ◇ = B / W





Headliner Led Array Down

HDL - LED ARRAY DOWN

110-240V / 50-60Hz
 INCL.POWER SUPPLY
 INCL.LED ARRAY 280mm - 3000K - 7,5W/array - 3214lm/m - 120lm/W
 EXCL.HDL - PC SBL PROFILE

CE 1.6 IP20 0,1

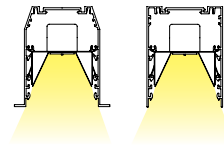

Requirements	Watt	L (mm)	EVG ■	EVG ■	EVG ■
HDL - PC SBL PROFILE 378 02 05 SBL MAX.L / PROFILE : 5.8m - 0,2 / m	4 x 7,5	1120	<input type="text"/>	<input type="text" value="DIM 1-10V"/>	<input type="text" value="DIM DALI SWITCH"/>
	6 x 7,5	1680	378 610 62 E	378 610 62 ED1	378 610 62 ED2
	8 x 7,5	2240	378 610 82 E		378 610 82 ED2

p

Requirement / HDL - PC profile

HDL - PC SBL PROFILE

378 02 05 SBL
 MAX.L / PROFILE : 5.8m - 0,2 / m



HDL - PC SBL PROFILE



Microline 30+Led Array Down

MIC30+ - LED ARRAY DOWN

110-240V / 50-60Hz
 INCL.POWER SUPPLY
 INCL.LED ARRAY 280mm - 3000K - 7,5W/array - 3214lm/m - 120lm/W

CE 1.6 IP20 0,1



Requirements	Watt	L (mm)	EVG ■	EVG ■	EVG ■
	4 x 7,5	1120	<input type="text"/>	<input type="text" value="DIM 1-10V"/>	<input type="text" value="DIM DALI SWITCH"/>
	6 x 7,5	1680	346 610 62 E	346 610 62 ED1	346 610 62 ED2
	8 x 7,5	2240	346 610 82 E		346 610 82 ED2



NoBody 200 Led Array Down

NB200 - LED ARRAY DOWN

110-240V / 50-60Hz
 INCL.POWER SUPPLY
 INCL.LED ARRAY 280mm - 3000K - 7,5W/array - 3214lm/m - 120lm/W
 INCL.1 x PC OPAL DOWN

CE 1,6 IP20 (0,1)

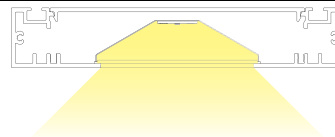

	Watt	L (mm)	EVG ■	EVG ■	EVG ■
				DIM 1 10V	DIM DALI SWITCH
	4 x 7,5	1220	331 610 42 E	331 610 42 ED1	331 610 42 ED2



NoBody 200 Led Array Up

NB200 - LED ARRAY UP

110-240V / 50-60Hz
 INCL.POWER SUPPLY
 INCL.LED ARRAY 280mm - 3000K - 7,5W/array - 3214lm/m - 120lm/W
 INCL.1 x PC CLEAR UP

CE 1,6 IP20 (0,1)

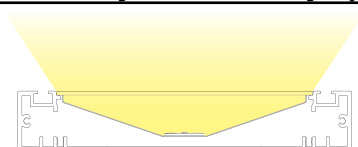

	Watt	L (mm)	EVG ■	EVG ■	EVG ■
				DIM 1 10V	DIM DALI SWITCH
	4 x 7,5	1220	331 620 42 E	331 620 42 ED1	331 620 42 ED2



NoBody 200 Led Array Down-Up

NB200 - LED ARRAY DOWN-UP

110-240V / 50-60Hz
 INCL.POWER SUPPLY
 INCL.LED ARRAY 280mm - 3000K - 7,5W/array - 3214lm/m - 120lm/W
 INCL.1 x PC OPAL DOWN
 INCL.1 x PC CLEAR UP
 1 CIRCUIT

CE 1,6 IP20 (0,1)

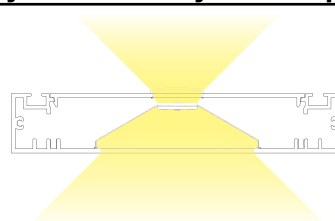

	Watt	L (mm)	EVG ■	EVG ■	EVG ■
				DIM 1 10V	DIM DALI SWITCH
	4 x 7,5 DWN + 2 x 7,5 UP	1220	331 630 62 E		331 630 62 ED2

EXTERIOR LIGHTING

The Lighting Bible® 10 catalogue offers a vast range of outdoor lighting solutions, ranging from ceiling to wall and floor applications, both recessed and surface mounted. The following pages complete the existing collection.







B-LINER
PAG 112



LOGIC MINI W R
PAG 114



MOMBA LED SP
PAG 116



LOGIC F1
PAG 118



LOGIC MINI W S
PAG 114



LOGIC F2
PAG 118



TACTIC WALLWASH
PAG 121



LOGIC R WALLWASH
PAG 121



LOGIC R A WALLWASH
PAG 121

EXTERIOR LIGHTING

B-LINER	PAG 112
LOGIC F1	PAG 118
LOGIC F2	PAG 118
LOGIC MINI W R	PAG 114
LOGIC MINI W S	PAG 114
LOGIC R WALLWASH	PAG 121
LOGIC R A WALLWASH	PAG 121
MOMBA LED SP	PAG 116
TACTIC WALLWASH	PAG 121

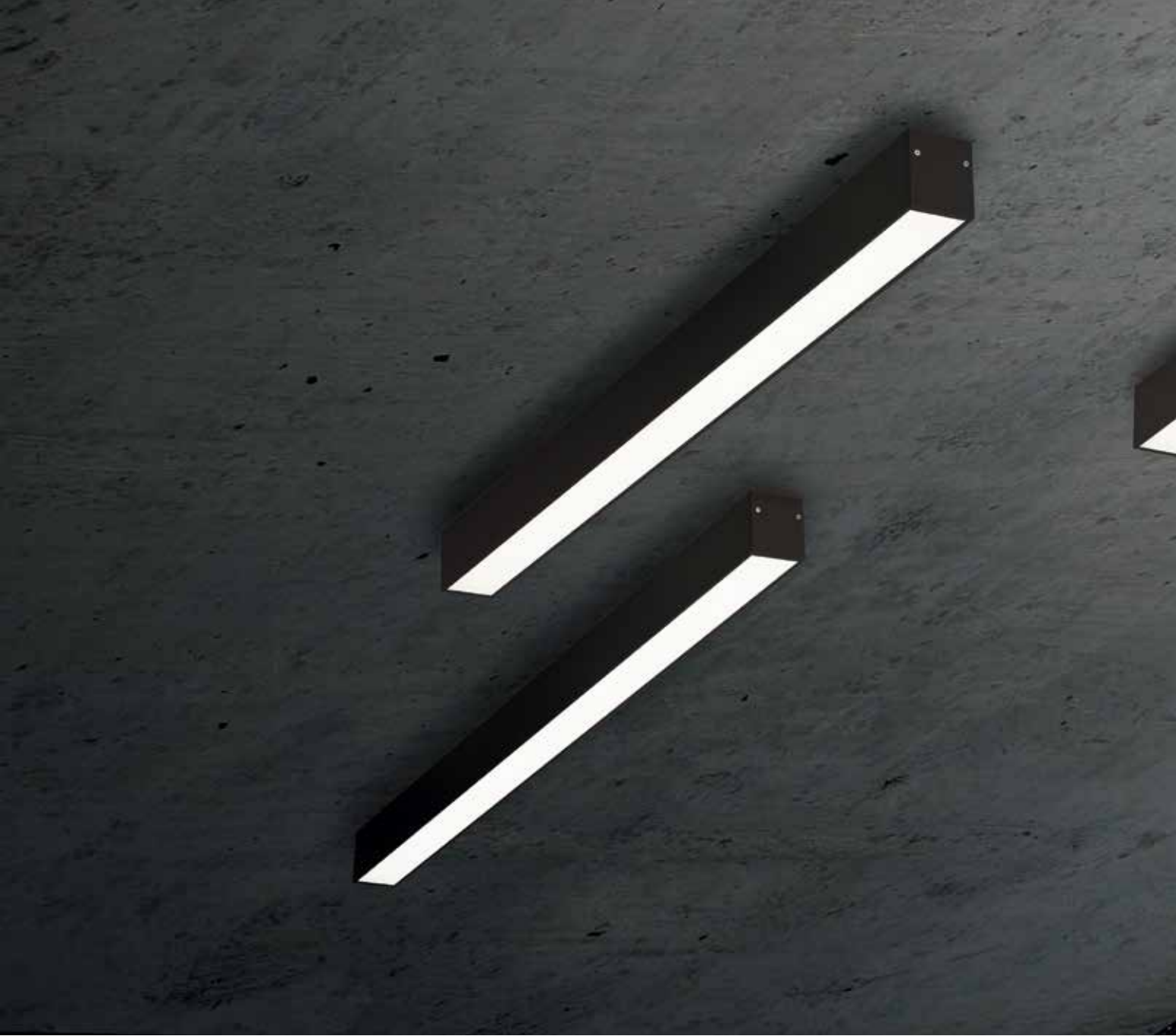



   **B-Liner 65 IP**

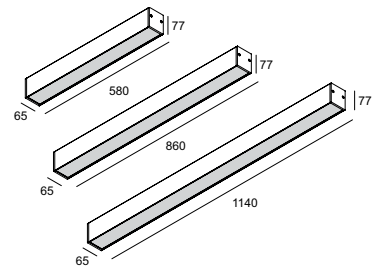

B-LINER 6522 IP ◇

388 01 22 ◇



◇ = A / N / W

INCL.1 x PC SBL

INCL.2 x LED ARRAY 7,5W / 3000K ● / 900lm

INCL.1 x LED POWERSUPPLY

110-240V / 50-60Hz

  IP65

B-LINER 6532 IP ◇

388 01 32 ◇



◇ = A / N / W

INCL.1 x PC SBL

INCL.3 x LED ARRAY 7,5W / 3000K / 900lm

INCL.1 x LED POWERSUPPLY

110-240V / 50-60Hz

  IP65

B-LINER 6542 IP ◇

388 01 42 ◇



◇ = A / N / W

INCL.1 x PC SBL

INCL.4 x LED ARRAY 7,5W / 3000K / 900lm

INCL.1 x LED POWERSUPPLY

110-240V / 50-60Hz

  IP65

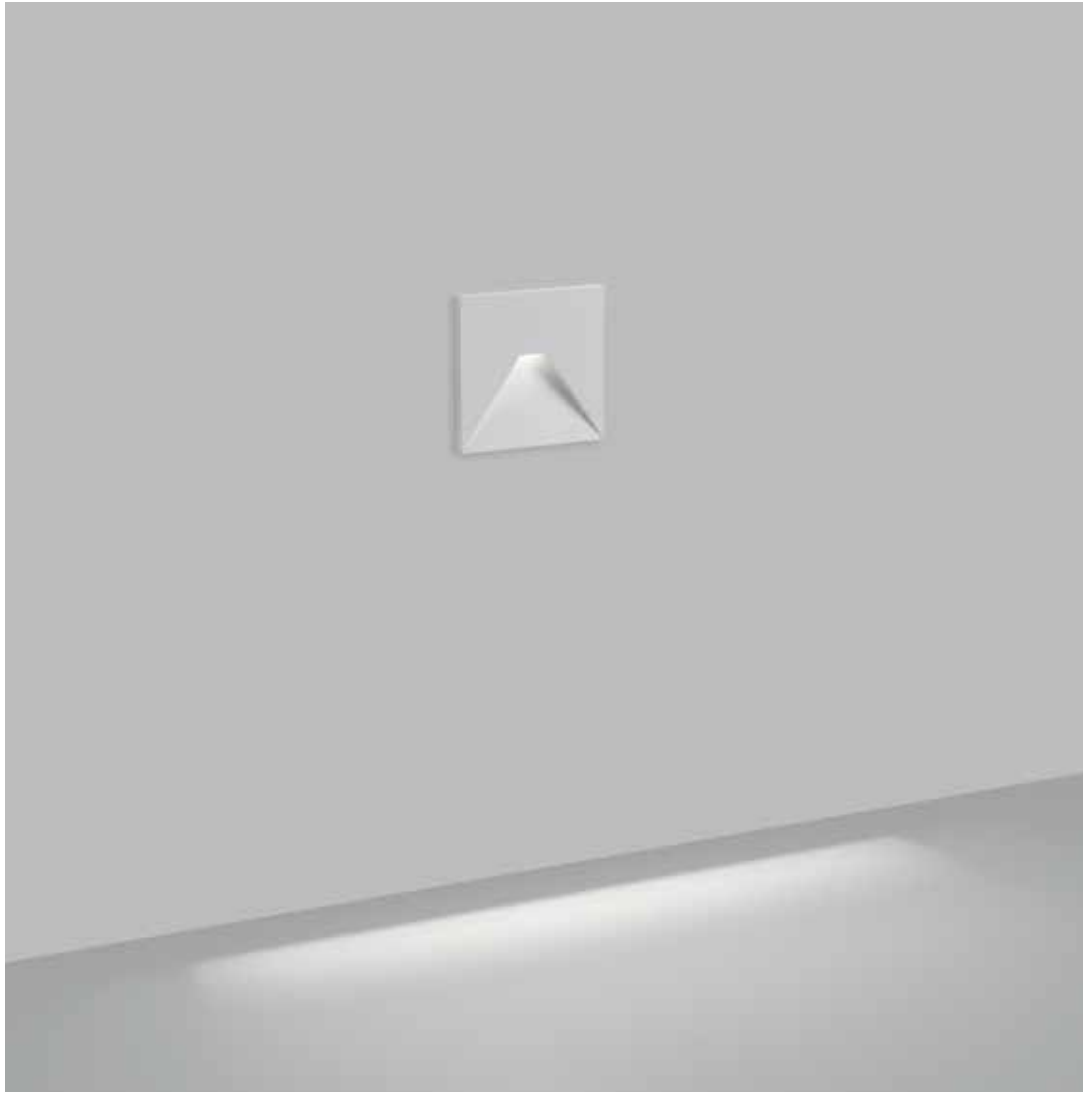

FULL INFO / PAG TEC

Options

INSTALLATION

CONCRETE BOX 188
270 11 188



Ø60 x 65

Ø67 x 70

CONTROL GEAR

LED POWER SUPPLY
24V-DC / 20W
300 89 24 20



146 x 55 x 19



Logic Mini W R

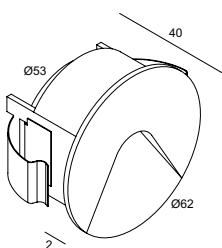

Ø 55 x 50

LOGIC MINI W R

304 30 12

◇ = A / W

INCL. 1 x POWERLED WHITE 0,6W / 3000K
EXCL. LED POWER SUPPLY 24V-DC

CE 0,2 IP54

OPTIONS

CONCRETE BOX 188
LED POWER SUPPLY 24V-DC

CRI>80 40lm



Logic Mini W S

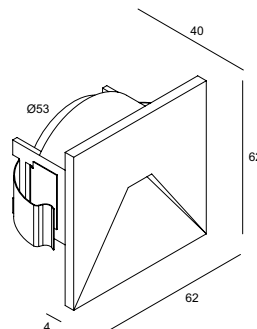

Ø 55 x 50

LOGIC MINI W S

304 31 12

◇ = A / W

INCL. 1 x POWERLED WHITE 0,6W / 3000K
EXCL. LED POWER SUPPLY 24V-DC

CE 0,2 IP54

OPTIONS

CONCRETE BOX 188
LED POWER SUPPLY 24V-DC

CRI>80 40lm





Momba LED SP

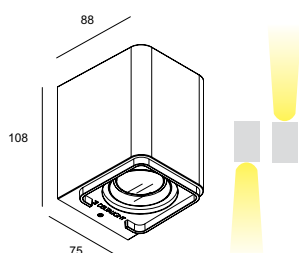

MOMBA LED SP WW ◇
225 20 18112 ◇
 ◇ = N
 INCL.1 x POWERLED WHITE 3W / 3000K ●
 INCL.1 x LENS 4°
 INCL.LED POWER SUPPLY 700mA-DC
 120-240V / 50-60Hz

◇ CE 0,9 IP65

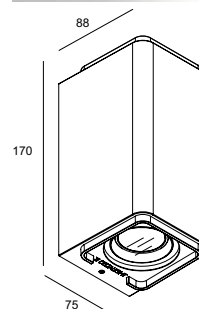

MOMBA DOWN-UP LED SP WW ◇
225 20 18212 ◇
 ◇ = N
 INCL.2 x POWERLED WHITE 3W / 3000K ●
 INCL.2 x LENS 4°
 INCL.LED POWER SUPPLY 700mA-DC
 120-240V / 50-60Hz

◇ CE 1,3 IP65

CRI>80 162lm



MOMBA DOWN-UP LED SP



MOMBA DOWN-UP LED

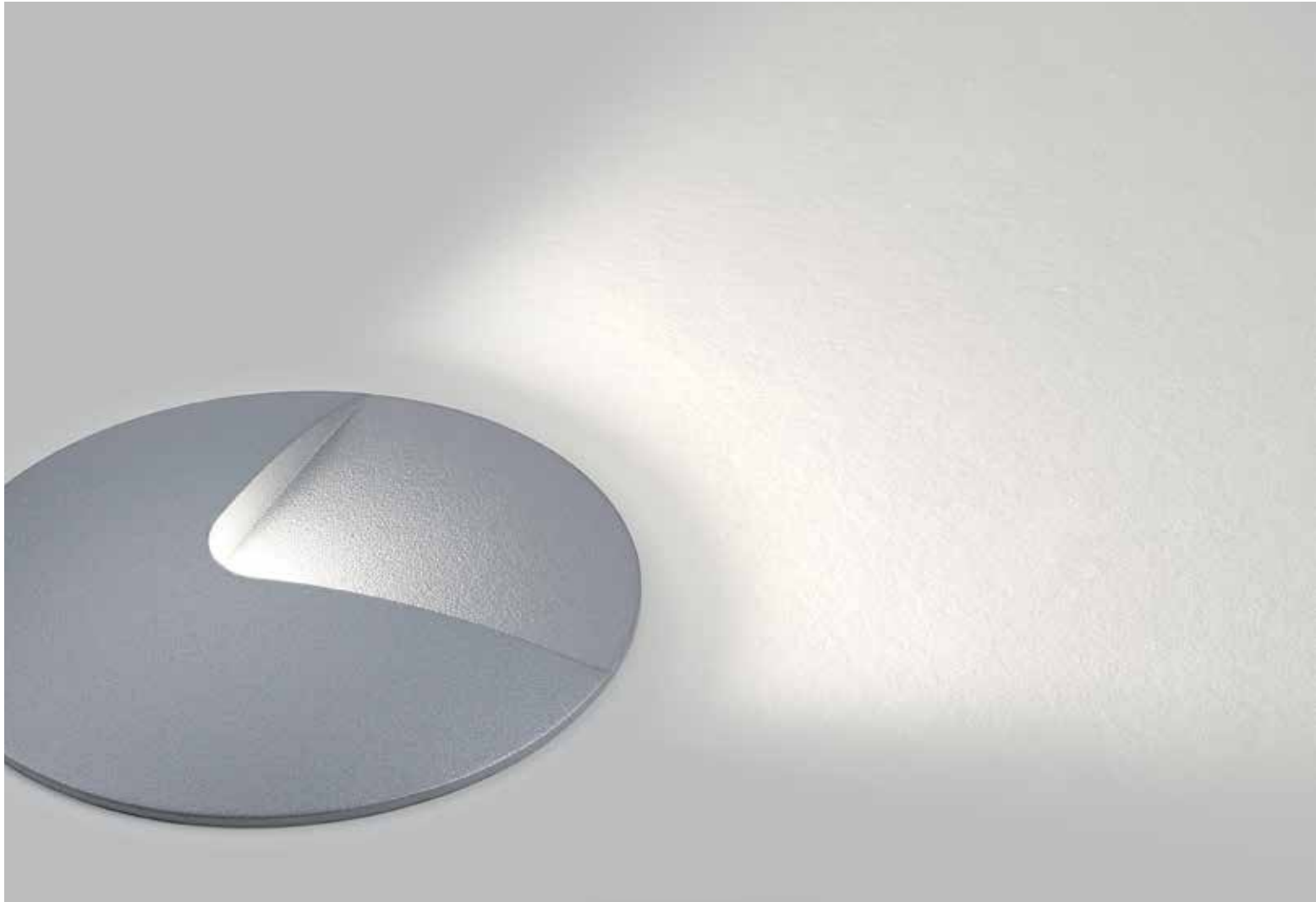

FULL INFO / PAG TEC

Options

INSTALLATION



GENIE BOX 90 R 220 x 155 x 146 224 x 159 x 150
213 19 09

CBOX

140 x 140 x 173 142 x 142 x 300
216 12 00

CONTROL GEAR



LED POWER SUPPLY 146 x 55 x 19
24V-DC / 20W
300 89 24 20



Logic F1

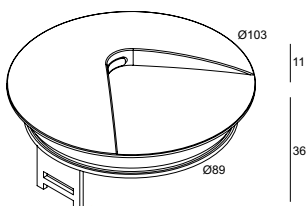

Ø 93 x 40
LOGIC F1 ◊
213 47 112 ◊
 ◊ = A
 INCL. 1 x POWERLED WHITE 0,6W / 3000K ●
 EXCL. LED POWER SUPPLY 24V-DC
 max.600kg

CE 0,3 IP67

OPTIONS
 GENIE BOX 90R
 CBOX
 LED POWER SUPPLY 24V-DC

CRI>80 40lm



Logic F2

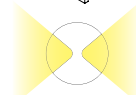
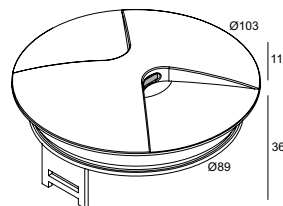
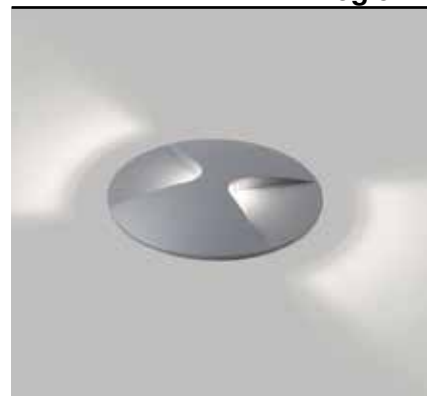

Ø 93 x 40
LOGIC F2 ◊
213 47 122 ◊
 ◊ = A
 INCL. 2 x POWERLED WHITE 0,6W / 3000K ●
 EXCL. LED POWER SUPPLY 24V-DC
 max.600kg

CE 0,3 IP67

OPTIONS
 GENIE BOX 90R
 CBOX
 LED POWER SUPPLY 24V-DC

CRI>80 40lm

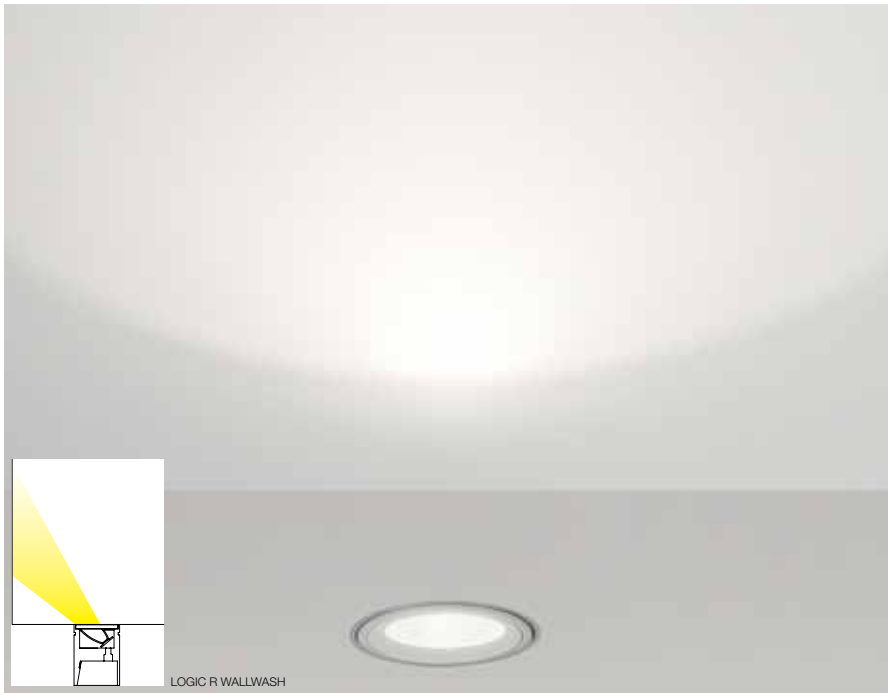

TACTIC BOX 60R



LOGIC R WALLWASH - IP68 CONNECTOR 3P

FULL INFO / PAG TEC

Options

INSTALLATION



GENIE BOX 90 R 213 19 09	220 x 155 x 146	224 x 159 x 150
CBOX 216 12 00	140 x 140 x 173	142 x 142 x 300
TACTIC BOX 60 R 213 19 10	170 x 120 x 100	175 x 125 x 105
IP68 CONNECTION KIT 216 12 01	95 x 45 x 25	
IP68 CONNECTOR 3P 216 12 02	Ø 23 x 68	

CONTROL GEAR



LED POWER SUPPLY 24V-DC / 20W 300 89 24 20	146 x 55 x 19
LED POWER SUPPLY 24V-DC / 40W 300 89 24 40	242 x 46 x 36
LED POWER SUPPLY 24V-DC / 60W 300 89 24 60	211 x 43 x 28
LED POWER SUPPLY 24V-DC / 150W 300 89 24 150	260 x 60 x 49

led **Tactic Wallwash**

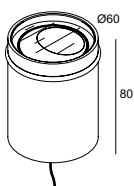

61 x 100

TACTIC WALLWASH ◇

213 45 212 ◇

◇ = ANO

INCL. 1 x POWERLED WHITE 4W / 3000K ●

INCL. 1 x CABLE H05 RN-F 2 x 1mm² 0,5m

EXCL. LED POWER SUPPLY 24V-DC

IEC 60598-2-13 : max.150kg 25N/cm²

ESG 5mm

IP67

OPTIONS

LED POWER SUPPLY 24V-DC

CBOX

IP68 CONNECTION KIT

IP68 CONNECTOR 3P

TACTIC BOX 60 R

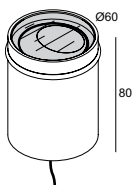

61 x 100

TACTIC WALLWASH SBL ◇

213 45 212S ◇

◇ = ANO

INCL. 1 x GLASS SBL

INCL. 1 x POWERLED WHITE 4W / 3000K ●

INCL. 1 x CABLE H05 RN-F 2 x 1mm² 0,5m

EXCL. LED POWER SUPPLY 24V-DC

IEC 60598-2-13 : max.150kg 25N/cm²

ESG 5mm

IP67

OPTIONS

LED POWER SUPPLY 24V-DC

CBOX

IP68 CONNECTION KIT

IP68 CONNECTOR 3P

TACTIC BOX 60 R

CRI >80 335lm (4W)

led **Logic R Wallwash**

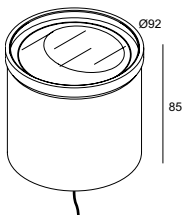

93 x 125

LOGIC R WALLWASH ◇

213 47 212 ◇

◇ = ANO

INCL. 1 x POWERLED WHITE 7W / 3000K ●

INCL. CABLE H05 RN-F 2 x 1mm² 0,5m

INCL. LED POWER SUPPLY 350mA-DC

INCL. IP68 CONNECTOR 3P

IEC 60598-2-13: max.150kg 25N/cm²

ESG 5mm

100-240V / 50-60Hz

IP67

OPTIONS

CBOX

GENIE BOX 90 R

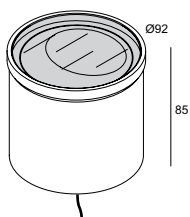

93 x 125

LOGIC R WALLWASH SBL ◇

213 47 212S ◇

◇ = ANO

INCL. 1 x GLASS SBL

INCL. 1 x POWERLED WHITE 7W / 3000K ●

INCL. CABLE H05 RN-F 2 x 1mm² 0,5m

INCL. LED POWER SUPPLY 350mA-DC

INCL. IP68 CONNECTOR 3P

IEC 60598-2-13: max.150kg 25N/cm²

ESG 5mm

100-240V / 50-60Hz

IP67

OPTIONS

CBOX

GENIE BOX 90 R

CRI >80 525lm (7W)

led **Logic R A Wallwash**

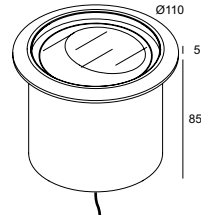
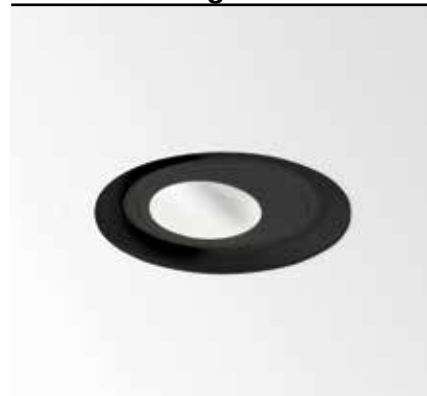

93 x 125

LOGIC R A WALLWASH ◇

213 48 212 ◇

◇ = ANO / B

INCL. 1 x POWERLED WHITE 7W / 3000K ●

INCL. CABLE H05 RN-F 2 x 1mm² 0,5m

INCL. LED POWER SUPPLY 350mA-DC

INCL. IP68 CONNECTOR 3P

IEC 60598-2-13: max.150kg 25N/cm²

ESG 5mm

100-240V / 50-60Hz

IP67

OPTIONS

CBOX

GENIE BOX 90 R

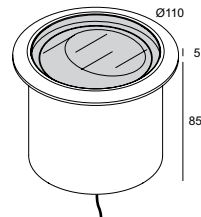

93 x 125

LOGIC R A WALLWASH SBL ◇

213 48 212S ◇

◇ = ANO / B

INCL. 1 x GLASS SBL

INCL. 1 x POWERLED WHITE 7W / 3000K ●

INCL. CABLE H05 RN-F 2 x 1mm² 0,5m

INCL. LED POWER SUPPLY 350mA-DC

INCL. IP68 CONNECTOR 3P

IEC 60598-2-13: max.150kg 25N/cm²

ESG 5mm

100-240V / 50-60Hz

IP67

OPTIONS

CBOX

GENIE BOX 90 R

CRI >80 525lm (7W)

EXTENDED SERIES

The following pages
show additional versions
of existing collections,
and new accessories
for Lighting Bible® 10
luminaires.







RAND LED
INT 127



REO X
INT 129



LOGIC RA
INT 129



CARREE X LED
INT 129

EXTENDED SERIES

CARREE X LED	PAG 129
LOGIC R A	PAG 129
RAND LED	PAG 127
REO X	PAG 129



Rand LED

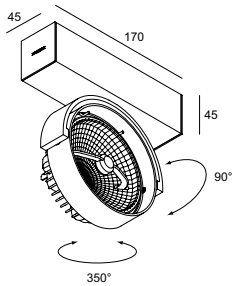

RAND 111 LED DIM8 ◇
285 50 124 ED8 ◇
 ◇ = A / B / W
 INCL. 1 x LED 111 LAMP 24° 12V-DC / 15,5W / 2800K ● / 550lm
 G53 / 220-240V / 50-60Hz / TE

□ CE 0,6 IP20

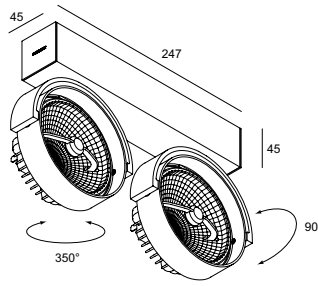

RAND 211 LED DIM8 ◇
285 50 224 ED8 ◇
 ◇ = A / B / W
 INCL. 2 x LED 111 LAMP 24° 12V-DC / 15,5W / 2800K ● / 550lm
 G53 / 220-240V / 50-60Hz / TE

□ CE 1,0 IP20

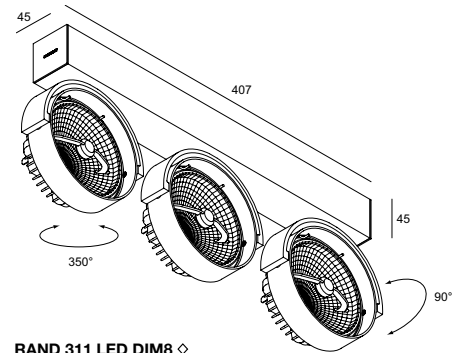

RAND 311 LED DIM8 ◇
285 50 324 ED8 ◇
 ◇ = A / B / W
 INCL. 3 x LED 111 LAMP 24° 12V-DC / 15,5W / 2800K ● / 550lm
 G53 / 220-240V / 50-60Hz / TE

◇ CE 1,6 IP20

DIM8: DIMMING BY FALLING EDGE DIMMER

DIM8: DIMMING BY FALLING EDGE DIMMER

DIM8: DIMMING BY FALLING EDGE DIMMER





LOGIC R A - BLACK ANODIZED

FULL INFO / PAG TEC

Options

INSTALLATION



GENIE BOX 90 R 220 x 155 x 146 224 x 159 x 150
213 19 09

CBOX 140 x 140 x 173 142 x 142 x 300
216 12 00

CONTROL GEAR



LED POWER SUPPLY 115 x 34 x 19
350mA-DC / 15W
300 90 91

LED POWER SUPPLY 76 x 34 x 24
6 Dim8

3 12

7

9 3

111 x 38 x 28

81 x 35 x 23

1 2

LED POWER CONVERTER 90 x 53 x 58
24V-DC → MULTI CURRENT / 48W DIM9
300 90 67

LED POWER SUPPLY 124,5 x 79 x 22
MULTI-POWER
300 90 914

LED POWER SUPPLY 103 x 67 x 21
MULTI-POWER Dim1
300 90 64

LED POWER SUPPLY 165 x 47 x 35
MULTI-POWER Dim6
300 90 61

LED POWER SUPPLY 103 x 67 x 21
MULTI-POWER Dim7
300 90 60

LED POWER SUPPLY 111 x 79 x 22
MULTI-POWER Dim9
300 90 63

Fixation S1

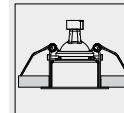

Fixation S2

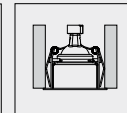

DIM1: dimming by 1-10V
 DIM6: dimming by push button / falling edge dimmer
 DIM7: dimming by push button / 1-10V
 DIM8: dimming by falling edge dimmer
 DIM9: dimming by push button / 1-10V / Dali

Reo X



IP65

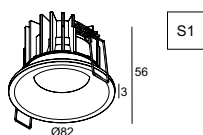

76 x 55 max.22

REO X 3033-65 S1 ◊
202 256 28122 ◊
 ◊ = A / W
 FIXED
 INCL.1 x PC
 INCL.1 x POWERLED WHITE 7W / 3000K ●
 INCL.1 x REFLECTOR FL-33°
 EXCL.LED POWER SUPPLY 350mA-DC

CE 0,4 IP65

OPTIONS
 LED POWER SUPPLY 350mA-DC / DIM

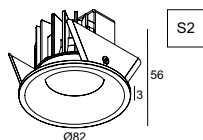

76 x 55

REO X 3033-65 S2 ◊
202 2562 28122 ◊
 ◊ = A / W
 FIXED
 INCL.1 x PC
 INCL.1 x POWERLED WHITE 7W / 3000K ●
 INCL.1 x REFLECTOR FL-33°
 EXCL.LED POWER SUPPLY 350mA-DC

CE 0,4 IP65

OPTIONS
 LED POWER SUPPLY 350mA-DC / DIM

CRI >80 660lm (7W)
 ON REQUEST 2700K/4000K

Carree X LED



IP65

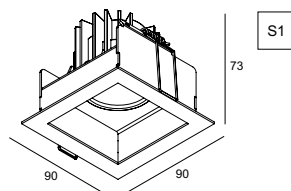

75 x 75 x 80 max.35

CARREE X LED 3033-65 S1 ◊
202 206 28122 ◊
 ◊ = A
 FIXED
 INCL.1 x POWERLED WHITE 7W / 3000K ●
 INCL.1 x REFLECTOR FL-33°
 INCL.1 x PC
 EXCL.LED POWER SUPPLY 350mA-DC

CE 0,3 IP65

OPTIONS
 LED POWER SUPPLY 350mA-DC / DIM

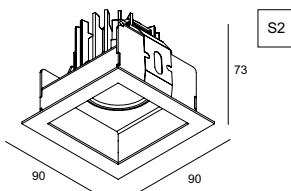

75 x 75 x 80

CARREE X LED 3033-65 S2 ◊
202 207 28122 ◊
 ◊ = A
 FIXED
 INCL.1 x POWERLED WHITE 7W / 3000K ●
 INCL.1 x REFLECTOR FL-33°
 INCL.1 x PC
 EXCL.LED POWER SUPPLY 350mA-DC

CE 0,3 IP65

OPTIONS
 LED POWER SUPPLY 350mA-DC / DIM

CRI >80 660lm (7W)

Logic R A

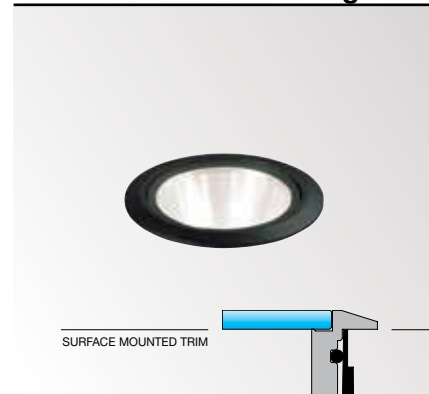

SURFACE MOUNTED TRIM

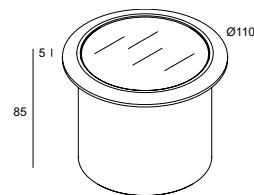

93 x 125

LOGIC R A 3011 ◊
213 48 18112 ◊
 INCL.1 x REFLECTOR SP-11°

LOGIC R A 3030 ◊
213 48 18122 ◊
 INCL.1 x REFLECTOR FL-30°

LOGIC R A 3055 ◊
213 48 18132 ◊
 INCL.1 x REFLECTOR WFL-55°

◊ = ANO / B*
 INCL.CABLE H05 RN-F 2 x 1mm² 0,5m
 INCL.1 x POWERLED WHITE 7W / 3000K ●
 INCL.LED POWER SUPPLY 350mA-DC
 INCL.IP68 CONNECTOR 3P
 100-240V / 50-60Hz
 IEC 60598-2-13: max.150kg 25N/cm²
 ESG 5mm

CE 1,0 IP67

OPTIONS
 CBOX
 GENIE BOX 90 R

*Black Anodised

CRI >80 525lm (7W)



Suspension trimless O.F.A.

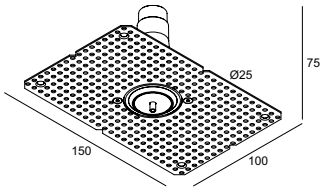

- ⓘ 62 x 80 max.25
- ⓘ 102 x 80 (CONCRETE)

SUSPENSION TRIMLESS O.F.A.
328 10 01

INCL.1 x AUTOMATIC ADJUSTMENT

0,2

Suspension + connection trimless O.F.A.

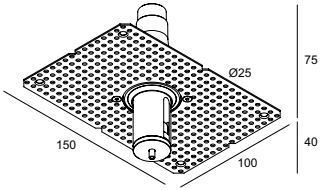

- ⓘ 62 x 80 max.25
- ⓘ 102 x 80 (CONCRETE)

SUSPENSION + CONNECTION TRIMLESS O.F.A.
328 10 02

INCL.1 x CONNECTOR max. 3x 2,5 mm²
INCL.1 x AUTOMATIC ADJUSTMENT
4A / 250V

0,2

Connection trimless O.F.A.

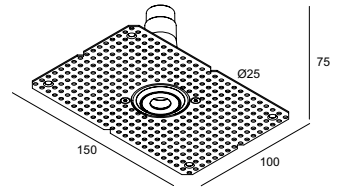

- ⓘ 62 x 80 max.25
- ⓘ 102 x 80 (CONCRETE)

CONNECTION TRIMLESS O.F.A.
328 10 03

INCL.1 x CONNECTOR max. 3x 2,5 mm²
4A / 250V

0,2

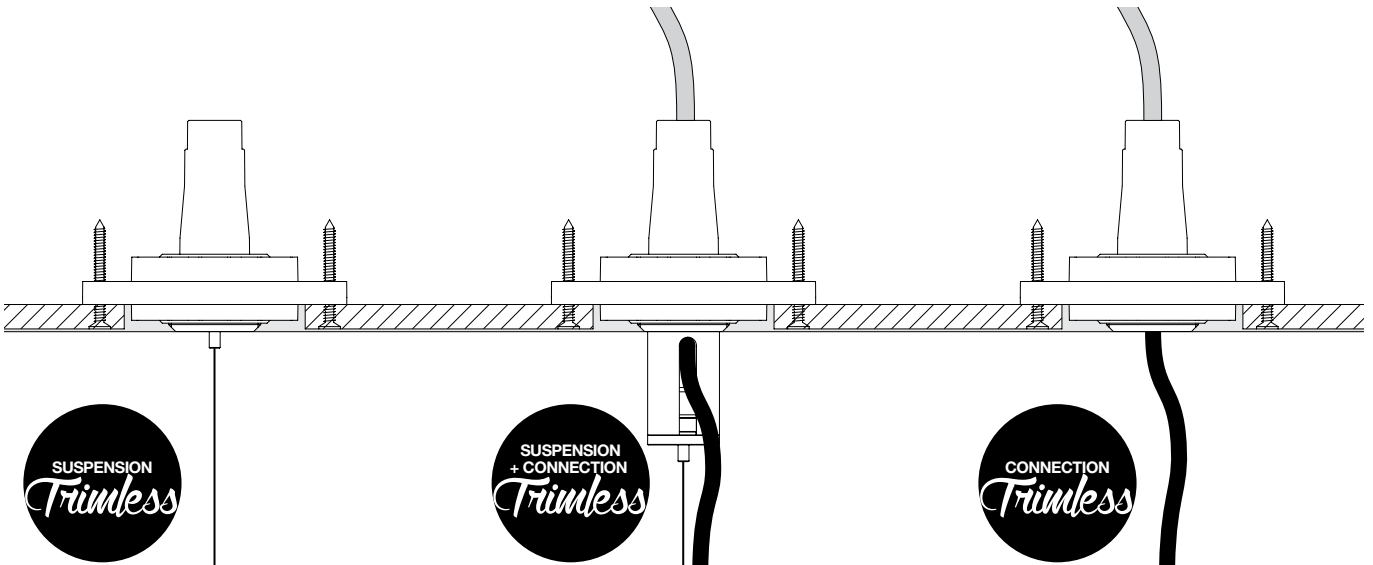



Accessories for

Opto Clip

Honeycomb 78

Softening Lens 78



GRID IN TRIMLESS OPTO
The Lighting Bible 10 INT 157
The Lighting Bible 10 / Product Catalog INT 107



GRID IN OPTO
The Lighting Bible 10 INT 173
The Lighting Bible 10 / Product Catalog INT 117



YOU-TURN OPTO
The Lighting Bible 10 INT 81
The Lighting Bible 10 / Product Catalog INT 53



YOU-TURN ON OPTO
The Lighting Bible 10 INT 232 / AD INT 534
The Lighting Bible 10 / Product Catalog INT 154 / AD INT 324



YOU-TURN ON OPTO AD
The Lighting Bible 10 INT 536 / INT 234
The Lighting Bible 10 / Product Catalog INT 326 / int 156

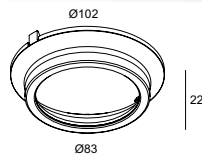

OPTO CLIP
201 02 00 ◇
◇ = B

0,1

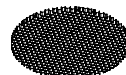
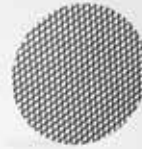

HONEYCOMB 78 ◇
201 02 01 ◇
◇ = B

0,1



SOFTENING LENS 78
201 02 04

0,1

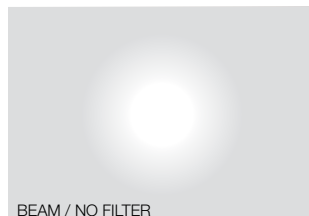

BEAM / NO FILTER



BEAM / HONEYCOMB



BEAM / SOFTENING LENS



Accessories for



GRID IN TRIMLESS HP
The Lighting Bible 10 INT 159
The Lighting Bible 10 / Product Catalog INT 109



GRID IN HP
The Lighting Bible 10 INT 175
The Lighting Bible 10 / Product Catalog INT 119



BOOSTER HP
The Lighting Bible 10 INT 274
The Lighting Bible 10 / Product Catalog INT 176



BOOSTER HP AD
The Lighting Bible 10 INT 548
The Lighting Bible 10 / Product Catalog INT 332

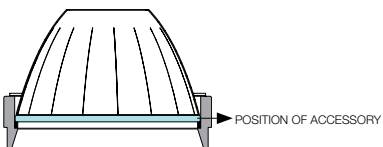

Honeycomb 87

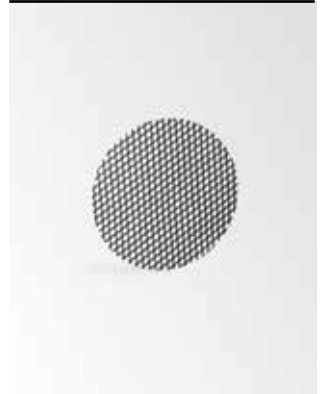

Ø87

HONEYCOMB 87 ◇

201 01 01 ◇

◇ = B

0.1



Linear Spread Lens 87

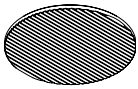

Ø87

LINEAR SPREAD LENS 87
201 01 02

0,1

Spread Lens 87



Ø87

SPREAD LENS 87
201 01 03

0,1

Softening Lens 87



Ø87

SOFTENING LENS 87
201 01 04

0,1

Glass SBL 87

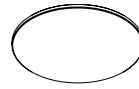

Ø87

GLASS SBL 87
201 01 05

0,1



BEAM / LINEAR SPREAD LENS

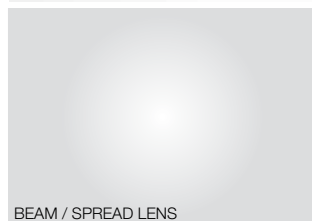

BEAM / SPREAD LENS

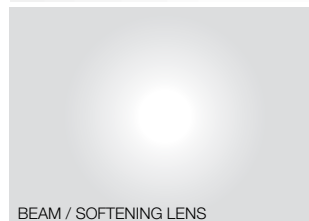

BEAM / SOFTENING LENS

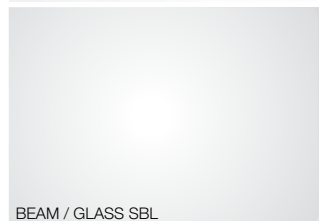

BEAM / GLASS SBL

Accessories for



TWEETER TRIMLESS REO
The Lighting Bible 10 INT 8
The Lighting Bible 10 / Product Catalog INT 6



TWEETER ST D REO
The Lighting Bible 10 INT 10
The Lighting Bible 10 / Product Catalog INT 8



TWEETER ON 1
The Lighting Bible 10 INT 227
The Lighting Bible 10 / Product Catalog INT 153



TWEETER ON 2
The Lighting Bible 10 INT 227
The Lighting Bible 10 / Product Catalog INT 153

PATENTED EX-CENTRIC ROTATION SYSTEM®

Tweeter Clip



TWEETER CLIP
201 03 00 ◊
◊ = B / W

0,1

Honeycomb 40



HONEYCOMB 40 ◊
201 03 01 ◊
◊ = ALU / B

0,1

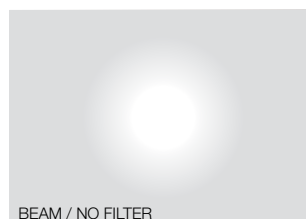

BEAM / NO FILTER

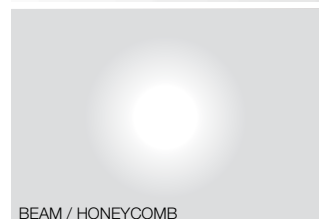

BEAM / HONEYCOMB



DESIGN PLUS 2014

Linear Spread Lens 40



LINEAR SPREAD LENS 40
201 03 02

0,1

Spread Lens 40



SPREAD LENS 40
201 03 03

0,1

Softening Lens 40



SOFTENING LENS 40
201 03 04

0,1

Glass SBL 40



GLASS SBL 40
201 03 05

0,1



BEAM / LINEAR SPREAD LENS

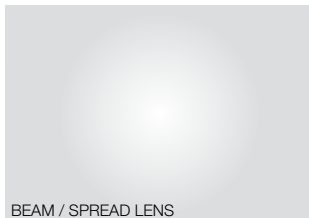

BEAM / SPREAD LENS



BEAM / SOFTENING LENS



BEAM / GLASS SBL

Accessories for



MINIGRID IN TRIMLESS HP
The Lighting Bible 10 INT 131
The Lighting Bible 10 / Product Catalog INT 89



MINIGRID IN HP
The Lighting Bible 10 INT 141
The Lighting Bible 10 / Product Catalog INT 95

Honeycomb 70



Ø70

HONEYCOMB 70 ◇

201 04 01 ◇

◇ = B

0.1



BEAM / NO FILTER



BEAM / HONEYCOMB



Linear Spread Lens 70

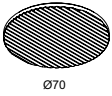

LINEAR SPREAD LENS 70
201 04 02

0,1

Spread Lens 70

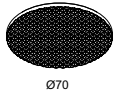
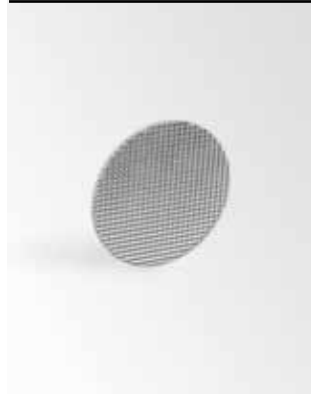

SPREAD LENS 70
201 04 03

0,1

Softening Lens 70



SOFTENING LENS 70
201 04 04

0,1

Glass SBL 70

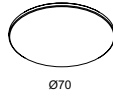

GLASS SBL 70
201 04 05

0,1



BEAM / LINEAR SPREAD LENS

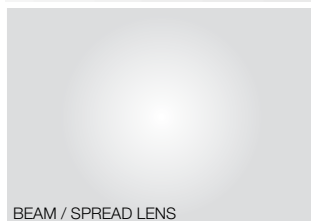

BEAM / SPREAD LENS



BEAM / SOFTENING LENS



BEAM / GLASS SBL

Accessories for



KIX
The Lighting Bible 10 INT 83
The Lighting Bible 10 / Product Catalog INT 51



KIX
The Lighting Bible 10 INT 137
The Lighting Bible 10 / Product Catalog INT 87



KIX
The Lighting Bible 10 INT 137
The Lighting Bible 10 / Product Catalog INT 87

Kap Kix

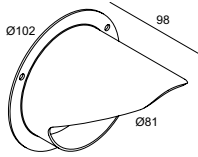

KAP KIX ◇
232 10 00 ◇
◇ = N

0,1

Honeycomb Kix

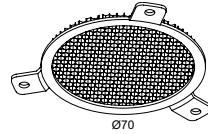
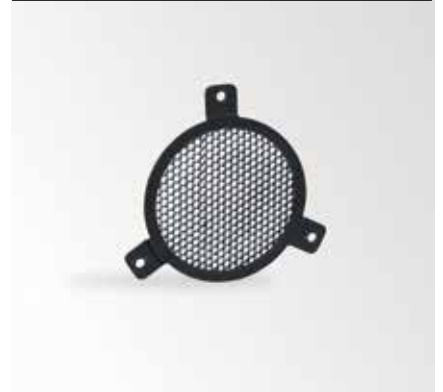

HONEYCOMB KIX ◇
232 10 03 ◇
◇ = N

0,1



KIX + KAP KIX



KIX + HONEYCOMB KIX + KAP KIX



Accessories for



Kap Striper



STRIPER
The Lighting Bible 10 INT 155
The Lighting Bible 10 / Product Catalog INT 98

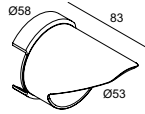

KAP STRIPER ◇
223 00 10 ◇
◇ = N

0,1



STRIPER + KAP STRIPER



TECHNICAL INFO

tech





CRI	LED	Power ¹	2700K ³	3000K	4000K	Typical values	
			Luminous flux @ 70°	Luminous flux @ 70°	Luminous flux @ 70°	Forw.Cur.	Forw.Volt.
CRI > 80 ²							
		7W	565 lm - 80 lm/W	585 lm - 83 lm/W	620 lm - 88 lm/W	700 mA	6,7 V *
		7 W	500 lm - 76 lm/W	525 lm - 80 lm/W	560 lm - 85 lm/W	350 mA	18,8 V *
		10 W	725 lm - 74 lm/W	770 lm - 78 lm/W	860 lm - 87 lm/W	350 mA	28,1 V *
		7 W	620 lm - 88 lm/W ⁴	660 lm - 94 lm/W	750 lm - 107 lm/W	350 mA	20,1 V *
		10 W	865 lm - 84 lm/W	920 lm - 89 lm/W	1045 lm - 101 lm/W	500 mA	20,7 V *
		18 W	1475 lm - 83 lm/W	1570 lm - 88 lm/W	1790 lm - 101 lm/W	500 mA	35,5 V *
		25 W	1990 lm - 77 lm/W	2130 lm - 82 lm/W	2420 lm - 93 lm/W	700 mA	37,0 V *
		29 W	-	3000 lm - 115 lm/W	-	600 mA	SYSTEM
		8 W	700 lm - 89 lm/W	700 lm - 89 lm/W	-	500 mA	15,8 V *
CRI > 90							
		7 W	455 lm - 65 lm/W	485 lm - 69 lm/W	-	700 mA	6,7 V *
		7 W	430 lm - 65 lm/W ON REQUEST	465 lm - 71 lm/W ON REQUEST	-	350 mA	18,8 V *
		10 W	615 lm - 63 lm/W ON REQUEST	680 lm - 69 lm/W ON REQUEST	-	350 mA	28,1 V *
		7 W	525 lm - 75 lm/W	580 lm - 82 lm/W	-	350 mA	20,1 V *
		10 W	735 lm - 71 lm/W	810 lm - 78 lm/W	-	500 mA	20,7 V *
		18 W	1284 lm - 72 lm/W	1295 lm - 73 lm/W	-	500 mA	35,5 V *
		25 W	1735 lm - 67 lm/W	1750 lm - 68 lm/W	-	700 mA	37,0 V *
		33 W	-	3000 lm - 91 lm/W	-	700 mA	SYSTEM
		8 W	700 lm - 57 lm/W	700 lm - 57 lm/W	-	500 mA	24,7 V *

* +/- 8%

All the technical parameters for LED-apply to the entire module. In view of the complex manufacturing process for light emitting diodes (LED), the typical values given in this **Lighting Bible®10** are merely statistical values that do not necessarily correspond to the actual technical parameters of an individual product; individual products may vary from the typical values. For most accurate info, please consult: www.deltalight.com/ledspecs.pdf

LED SPECS

Example

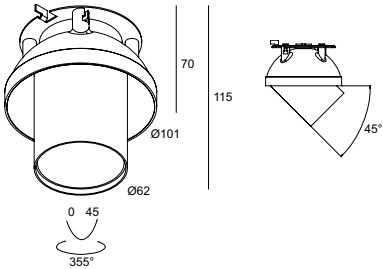

Example		i Ø KIT x 80	
		CRI > 80 2	CRI > 90
4000K ●	ON REQUEST		
3000K ●	660 lm (7W) 920 lm (10W)	580 lm (7W) 810 lm (10W)	
REFLECTOR FL-33°	SPY TRIMLESS 3033 ◇ 414 31 832 ◇ ◇ = W	SPY TRIMLESS 3033-9 ◇ 414 31 932 ◇ ◇ = W	
2700K ● 3	620 lm (7W) 4 865 lm (10W)	525 lm (7W) 735 lm (10W)	
REFLECTOR FL-33°	SPY TRIMLESS 2733 ◇ 414 31 822 ◇ ◇ = W	SPY TRIMLESS 2733-9 ◇ 414 31 922 ◇ ◇ = W	

ADJUSTABLE 0-45° / 355°
INCL. 1 x POWERLED WHITE 7-10W **1**
EXCL. LED POWER SUPPLY 350-500mA-DC

⏏ CE 0.7 IP20

REQUIREMENTS
MOUNTING KIT R102 TRIMLESS O.F.A.
400 91 02 OFA
SPY TUBE
414 01 00

OPTIONS
LED POWER SUPPLY 350-500mA-DC / DIM

ACCESSORIES
HONEYCOMB 50
LINEAR SPREAD LENS 50
SPREAD LENS 50
SOFTENING LENS 50
GLASS SBL 50





**CORRECT CONNECTION:
serial connection**

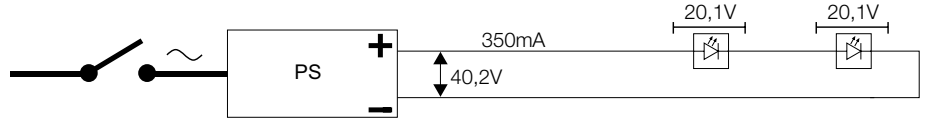

**WRONG CONNECTION:
parallel connection**

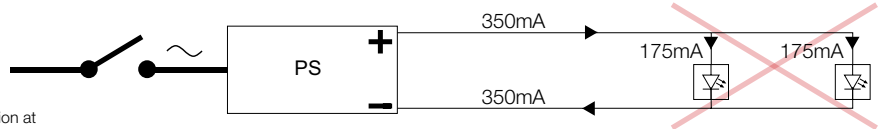

Depending on the number of fixtures the LED modules will function at half (2 LED's), one third (3 LED's) the luminous intensity. Moreover, due to different forward voltages the current will not split in equal part.

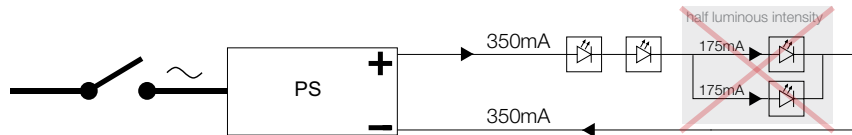

**WRONG CONNECTION:
testing of led modules on
switched on power supply**

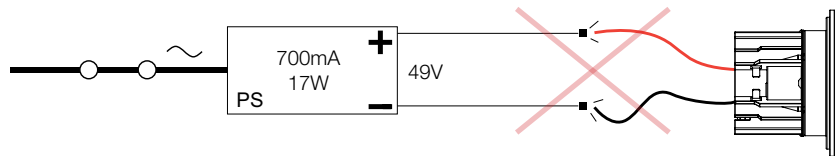

Risk for an output voltage that exceeds the max for the LED. A power supply that is switched on has max output on the secondary side (eg. 49V). The LED in eg. a Reo 3030 is 7W works at 350mA and 20,1V. 49V is far too big for the Reo 3030 >> LED will be damaged.

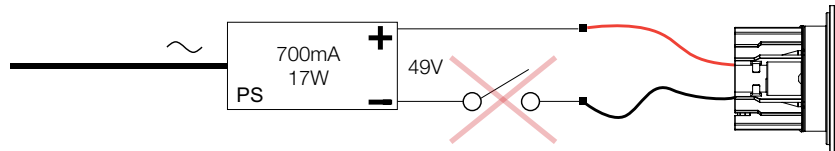

WRONG POWER SUPPLY:

Question:
How many Minigridd in 1 Reo (7W) luminaires can be connected to power supply 300 90 914?
7W x 4 = 28W >>> max **power** of 300 90 914 = 35W >>> **OK**
4 x 20,1V = 80,4V >>> max **voltage** of 300 90 914 = 72V >>> **NOT OK**

Answer:
3 x Minigridd in 1 Reo (7W) luminaires can be connected to power supply 300 90 914

Therefore: **always consult the matrix on PAGE TEC 5-11!**

300 90 914
0,1 IP20
124,5 x 79 x 22
110-240V / 50-60Hz
500mA / 35W / 72V
> 0,9
-



LED Power Supply 350mA-DC

Type					
LED POWER SUPPLY...	350mA / 6W	350mA / 15W (110-120V: 10W)	350mA / 16W Dim8	350mA / 17W (110-127V: 12W)	350mA / 18W
	300 90 104	300 90 91	300 90 3112	300 90 913	300 90 112
	IP67	IP20	IP65	IP20	IP54
Dimensions (L x W x H)	64 x 35 x 20	115 x 34 x 19	76 x 34 x 24	111 x 38 x 28	133 x 40 x 30,5
Input	220-240V / 50-60Hz	100-240V / 50-60Hz	100-240V / 50-60Hz	110-240V / 50-60Hz	220-240V / 0/50/60Hz
Output	2-20V-DC	0-43V-DC	17-46V-DC	0-49V-DC	4-52V-DC
	0,5	0,54 (240V) - 0,64 (100V)	> 0,9	0,55	> 0,9
Dim	-	-	Dim8 (30-100%)	-	Dim8 (35-100%)
CARREE 150 LED	0	1	2	2 (1)	2
CARREE RS LED	0	1	2	2 (1)	2
CARREE SC OK	0	1	2	2 (1)	2
CARREE ST OK LED	0	1	2	2 (1)	2
CARREE TRIMLESS OK LED	0	1	2	2 (1)	2
CARREE X LED	0	1	2	2 (1)	2
DIRO DUO ST OK LED	0	1/2	1	1 (1/2)	1
DIRO TRIMLESS LED	0	1	2	2 (1)	2
iMAX® --- BR20	0	0	0	0	0
iMAX® --- BR8	0	1	2	2 (1)	2
iMAX® --- CL	0	0	0	0	0
iMAX® --- BL4	0	0	0	0	0
iMAX® --- XR13	0	0	0	0	0
iMAX®+ --- BL4	0	0	0	0	0
iMAX®+ --- BR8	0	1	2	2 (1)	2
iMAX®+ --- CL	0	0	0	0	0
MINI SPY	4	12 (10)	min. 5 - max. 12	13 (12)	min. 2 - max. 14
REO X	0	1	2	2 (1)	2
SPY ST	0	1	2	2 (1)	2
SPY TRIMLESS	0	1	2	2 (1)	2











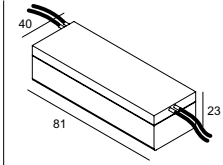
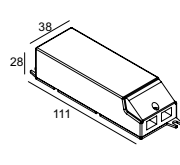
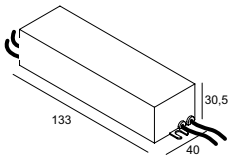
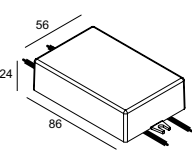





LED Power Supply 500mA-DC

Type			
LED POWER SUPPLY...	500mA / 6W	500mA / 20W (110V: 12W)	500mA / 32W Dim8
	300 90 22 U	300 90 92	300 90 5120
	IP67	IP20	IP65
Dimensions (L x W x H)	45 x 45 x 25	111 x 38 x 28	86 x 56 x 24
Input	120-240V / 50-60Hz	110-240V / 50-60Hz	110-240V / 0/50/60Hz
Output	2-14V-DC	3,5-45V-DC	24-45V-DC
	0,5	0,57	> 0,9
Dim	-	-	Dim8 (30-100%)
CARREE 150 LED	0	0	0
CARREE RS LED	0	0	0
CARREE SC OK	0	0	0
CARREE ST OK LED	0	0	0
CARREE TRIMLESS OK LED	0	0	0
CARREE X LED	0	0	0
DIRO DUO ST OK LED	0	0	0
DIRO TRIMLESS LED	0	0	0
iMAX® --- BR20	0	1	1
iMAX® --- BR8	0	1	min2-max2
iMAX® --- CL	0	0	0
iMAX® --- BL4	0	0	0
iMAX® --- XR13	0	2	min2-max2
iMAX®+ --- BL4	0	0	0
iMAX®+ --- BR8	0	1	min2-max2
iMAX®+ --- CL	0	0	0
MINI SPY	3	1,1 (6)	min. 7 -max. 13
REO X	0	0	0
SPY ST	0	1	min2-max2
SPY TRIMLESS	0	1	min2-max2







LED Power Supply 700mA-DC

Type				
LED POWER SUPPLY...	700mA / 12W	700mA / 17W	700mA / 36W Dim8	700mA / 32W Dim8
	300 90 43	300 90 93	300 90 123	300 90 7120
	   IP67	   IP20	   IP54	   IP65
Dimensions (L x W x H)	81 x 40 x 23	111 x 38 x 28	133 x 40 x 30,5	86 x 56 x 24
Input	120-240V 50-60Hz	230-240V / 50-60Hz	220-240V / 50-60Hz	110-240V / 50-60Hz
Output	2-18V-DC	3,5-26V-DC	4-52V-DC	24-46V-DC
	0,5	0,6	0,97	> 0,9
Dim	-	-	Dim8 (30-100%)	Dim8 (30-100%)
CARREE 150 LED	0	0	0	0
CARREE RS LED	0	0	0	0
CARREE SC OK	0	0	0	0
CARREE ST OK LED	0	0	0	0
CARREE TRIMLESS OK LED	0	0	0	0
CARREE X LED	0	0	0	0
DIRO DUO ST OK LED	0	0	0	0
DIRO TRIMLESS LED	0	0	0	0
iMAX® --- BR20	0	0	0	0
iMAX® --- BR8	0	0	0	0
iMAX® --- CL	5	min. 2 - max. 7	min. 2 - max. 15	min. 7 - max. 14
iMAX® --- BL4	1	2	5	min. 3 - max. 4
iMAX® --- XR13	0	0	0	0
iMAX®+ --- BL4	1	2	5	min. 3 - max. 4
iMAX®+ --- BR8	0	0	0	0
iMAX®+ --- CL	5	min. 2 - max. 7	min. 2 - max. 15	min. 7 - max. 14
MINI SPY	0	0	0	0
REO X	0	0	0	0
SPY ST	0	0	0	0
SPY TRIMLESS	0	0	0	0

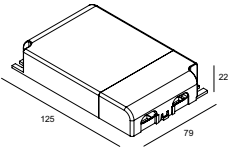

LED Power Supply Multi-Power





Type			
LED POWER SUPPLY MULTI-POWER	300 90 914		
	   IP20		
Dimensions (L x W x H)	124,5 x 79 x 22		
Input	110-240V / 50-60Hz		
Output	350mA / 25W / 74V-DC	500mA / 35W / 72V-DC	700mA / 50W / 70V-DC
	> 0,9		
Dim	-		

tech

CARREE 150 LED	3	0	0
CARREE RS LED	3	0	0
CARREE SC OK	3	0	0
CARREE ST OK LED	3	0	0
CARREE TRIMLESS OK LED	3	0	0
CARREE X LED	3	0	0
DIRO DUO ST OK LED	1	0	0
DIRO TRIMLESS LED	3	0	0
iMAX® --- BR20	0	1	0
iMAX® --- BR8	3	0	0
iMAX® --- CL	0	0	16
iMAX® --- BL4	0	0	7
iMAX® --- XR13	0	3	0
iMAX®+ --- BL4	0	0	7
iMAX®+ --- BR8	3	0	0
iMAX®+ --- CL	0	0	16
MINI SPY	16	16	0
REO X	3	0	0
SPY ST	3	0	0
SPY TRIMLESS	3	0	0

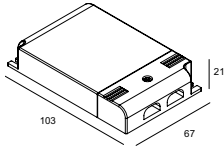





LED Power Supply Multi-Power DIM1

Type			
LED POWER SUPPLY MULTI-POWER DIM1			
	300 90 64		
	  IP20		
Dimensions (L x W x H)	103 x 67 x 21		
Input	120-240V / 50-60Hz		
Output	350mA / 20W / 60V-DC	500mA / 25W / 50V-DC (120V / 15W / 30V-DC)	
	> 0,9		
Dim	1-10V		
CARREE 150 LED	2	0	0
CARREE RS LED	2	0	0
CARREE SC OK	2	0	0
CARREE ST OK LED	2	0	0
CARREE TRIMLESS OK LED	2	0	0
CARREE X LED	2	0	0
DIRO DUO ST OK LED	1	0	0
DIRO TRIMLESS LED	2	0	0
iMAX® --- BR20	0	1(0)	0
iMAX® --- BR8	2	2(1)	0
iMAX® --- CL	0	0	0
iMAX® --- BL4	0	0	0
iMAX® --- XR13	0	2(1)	0
iMAX®+ --- BL4	0	0	0
iMAX®+ --- BR8	2	2(1)	0
iMAX®+ --- CL	0	0	0
MINI SPY	16	13	0
REO X	2	0	0
SPY ST	2	2(1)	0
SPY TRIMLESS	2	2(1)	0

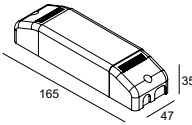



LED Power Supply Multi-Power DIM6

Type			
LED POWER SUPPLY MULTI-POWER DIM6			
	300 90 61		
	  IP20		
Dimensions (L x W x H)	165 x 47 x 35		
Input	220-240V / 50-60Hz		
Output	350mA / 17W (110V: 15W) / 43V-DC	500mA / 24W (110V: 15W) / 43V-DC	700mA / 32W (110V: 15W) / 36V-DC
	> 0,9		
Dim	Switch Dim / Falling edge dimming (30-100%)		
CARREE 150 LED	1	0	0
CARREE RS LED	1	0	0
CARREE SC OK	1	0	0
CARREE ST OK LED	1	0	0
CARREE TRIMLESS OK LED	1	0	0
CARREE X LED	1	0	0
DIRO DUO ST OK LED	1/2	0	0
DIRO TRIMLESS LED	1	0	0
iMAX® --- BR20	0	1(0)	0
iMAX® --- BR8	1	2(1)	0
iMAX® --- CL	0	0	9(4)
iMAX® --- BL4	0	0	3(1)
iMAX® --- XR13	0	2	0
iMAX®+ --- BL4	0	0	3(1)
iMAX®+ --- BR8	1	2(1)	0
iMAX®+ --- CL	0	0	9(4)
MINI SPY	12	11 (7)	0
REO X	1	0	0
SPY ST	1	2(1)	0
SPY TRIMLESS	1	2(1)	0



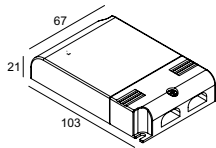

LED Power Supply Multi-Power DIM7

Type			
LED POWER SUPPLY MULTI-POWER DIM7			
300 90 60			
  IP20			
Dimensions (L x W x H)	103 x 67 x 21		
Input	110-240V / 50-60Hz		
Output	350mA / 15W / 43V-DC	500mA / 20W (110V: 15W) / 43V-DC	700mA / 25W (110V: 15W) / 36V-DC
λ	> 0,9		
Dim	Switch Dim / 1-10V		
CARREE 150 LED	1	0	0
CARREE RS LED	1	0	0
CARREE SC OK	1	0	0
CARREE ST OK LED	1	0	0
CARREE TRIMLESS OK LED	1	0	0
CARREE X LED	1	0	0
DIRO DUO ST OK LED	1	0	0
DIRO TRIMLESS LED	1	0	0
iMAX® --- BR20	0	1(0)	0
iMAX® --- BR8	1	1(0)	0
iMAX® --- CL	0	0	8 (5)
iMAX® --- BL4	0	0	3 (2)
iMAX® --- XR13	0	2(1)	0
iMAX®+ --- BL4	0	0	3 (2)
iMAX®+ --- BR8	1	1(0)	0
iMAX®+ --- CL	0	0	8 (5)
MINI SPY	12	11 (7)	0
REO X	1	0	0
SPY ST	1	1(0)	0
SPY TRIMLESS	1	1(0)	0

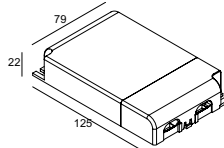

LED Power Supply Multi-Power DIM9

Type				
LED POWER SUPPLY MULTI-POWER DIM9				
300 90 63				
  IP20				
Dimensions (L x W x H)	111 x 79 x 22			
Input	120-240V / 50-60Hz			
Output	350mA / 25W / 74V-DC	500mA / 35W / 72V-DC	700mA / 50W / 70V-DC	1050mA / 50W / 48V-DC
λ	> 0,9			
Dim	Switch Dim / 1-10V / Dali			
CARREE 150 LED	3	0	0	0
CARREE RS LED	3	0	0	0
CARREE SC OK	3	0	0	0
CARREE ST OK LED	3	0	0	0
CARREE TRIMLESS OK LED	3	0	0	0
CARREE X LED	3	0	0	0
DIRO DUO ST OK LED	3	0	0	0
DIRO TRIMLESS LED	3	0	0	0
iMAX® --- BR20	0	1	0	0
iMAX® --- BR8	3	3	0	0
iMAX® --- CL	0	0	16	14
iMAX® --- BL4	0	0	5	0
iMAX® --- XR13	0	3	0	0
iMAX®+ --- BL4	0	0	5	0
iMAX®+ --- BR8	3	3	0	0
iMAX®+ --- CL	0	0	16	14
MINI SPY	16	16	0	0
REO X	3	0	0	0
SPY ST	3	3	0	0
SPY TRIMLESS	3	3	0	0



Dimmable LED Power Supply - Installation Scheme

- DIM1:** 1-10V
- DIM6:** SWITCH DIM
- DIM7:** 1-10V + SWITCH DIM
- DIM8:** FALLING EDGE DIMMING
- DIM9:** 1-10V + SWITCH DIM + DALI

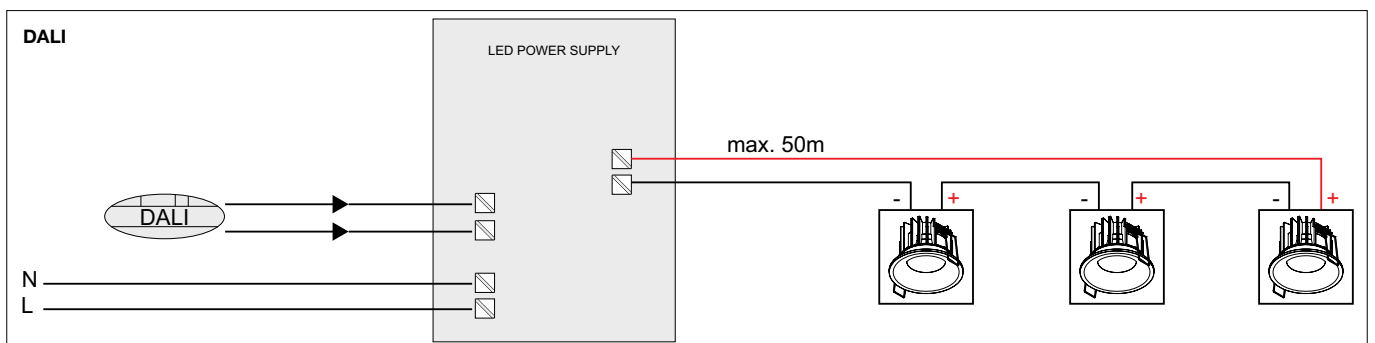
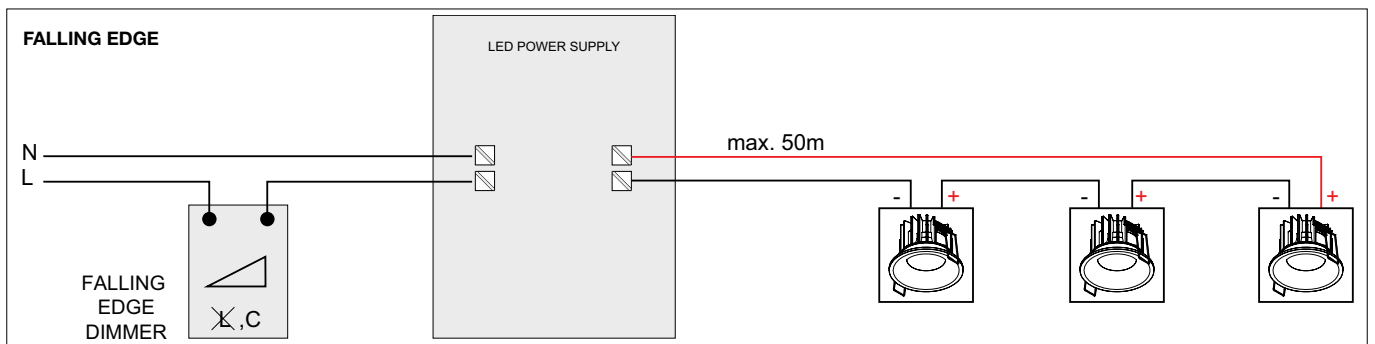
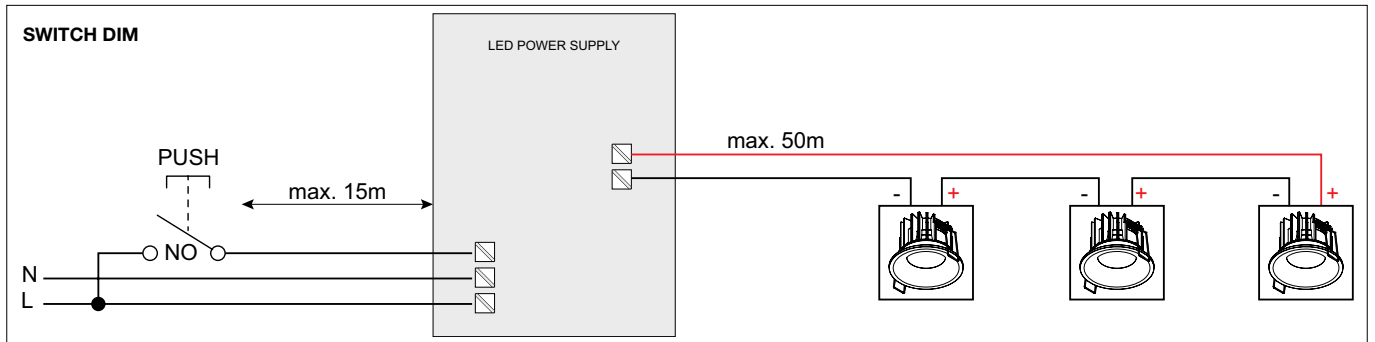
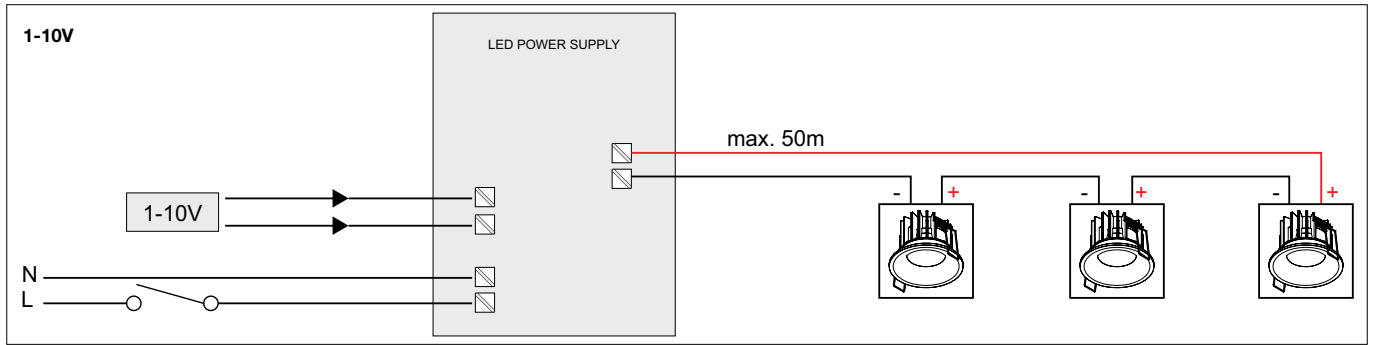





LED Power Supply 24V-DC

Type			
LED POWER SUPPLY...	24V-DC / 20W	24V-DC / 40W	24V-DC / 60W
	300 89 24 20	300 89 24 40	300 89 24 60
	IP20	IP67	IP54
Dimensions (L x W x H)	146 x 55 x 19	242 x 46 x 36	215 x 44 x 31
Input	110-240V / 50-60Hz	100-240V / 50-60Hz	120-240V / 50-60Hz
Output	24V-DC / 20W	24V-DC / 40W	24V-DC / 60W
	0,55	> 0,95	0,99
Dim	-	-	-
LOGIC F1	max. 40	max. 80	max. 120
LOGIC F2	max. 20	max. 40	max. 60
LOGIC MINI W R	max. 40	max. 80	max. 120
LOGIC MINI W S	max. 40	max. 80	max. 120
TACTIC WALLWASH	max. 5	max. 10	max. 15
LED POWER CONVERTER	-	-	max. 1
Type			
LED POWER SUPPLY...	24V-DC / 60W	24V-DC / 80W	24V-DC / 150W
	300 89 24 61	300 89 24 80	300 89 24 150
	IP54	IP67	IP20
Dimensions (L x W x H)	93 x 78 x 56	250 x 50 x 34	260 x 60 x 49
Input	100-240V / 50-60Hz	220-240V / 50-60Hz	220-240V / 50-60Hz
Output	24V-DC / 60W	24V-DC / 80W	24V-DC / 150W
	-	> 0,90	0,98
Dim	-	DIM 1	-
LOGIC F1	max. 120	max. 160	max. 300
LOGIC F2	max. 60	max. 80	max. 150
LOGIC MINI W R	max. 120	max. 160	max. 300
LOGIC MINI W S	max. 120	max. 160	max. 300
TACTIC WALLWASH	max. 15	max. 20	max. 30
LED POWER CONVERTER	max. 1	max. 1	max. 2

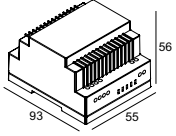
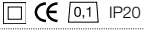

LED Power Converter 24V-DC → Multi Current / 48W DIM9

Type			
LED POWER CONVERTER	300 90 67		
			
Dimensions (L x W x H)	93 x 55 x 56		
Input	24V-DC		
Output	350mA / 48W	700mA / 32W	1050mA / 48W
			
Dim	Switch Dim / 1-10V / Dali		

CARREE 150 LED	3x2	0	0
CARREE RS LED	3x2	0	0
CARREE SC OK	3x2	0	0
CARREE ST OK LED	3x2	0	0
CARREE TRIMLESS OK LED	3x2	0	0
CARREE X LED	3x2	0	0
DIRO DUO ST OK LED	3x1	0	0
DIRO TRIMLESS LED	3x2	0	0
iMAX® --- BR20	0	0	0
iMAX® --- BR8	3x2	0	0
iMAX® --- CL	0	min. 3 - max. 10	min. 3 - max. 12
iMAX® --- BL4	0	4	0
iMAX® --- XR13	0	0	0
iMAX®+ --- BL4	0	4	0
iMAX®+ --- BR8	3x2	0	0
iMAX®+ --- CL	0	min. 3 - max. 10	min. 3 - max. 12
MINI SPY	3x(min. 3 - max. 13)	0	0
REO X	3x2	0	0
SPY ST	3x2	0	0
SPY TRIMLESS	3x2	0	0

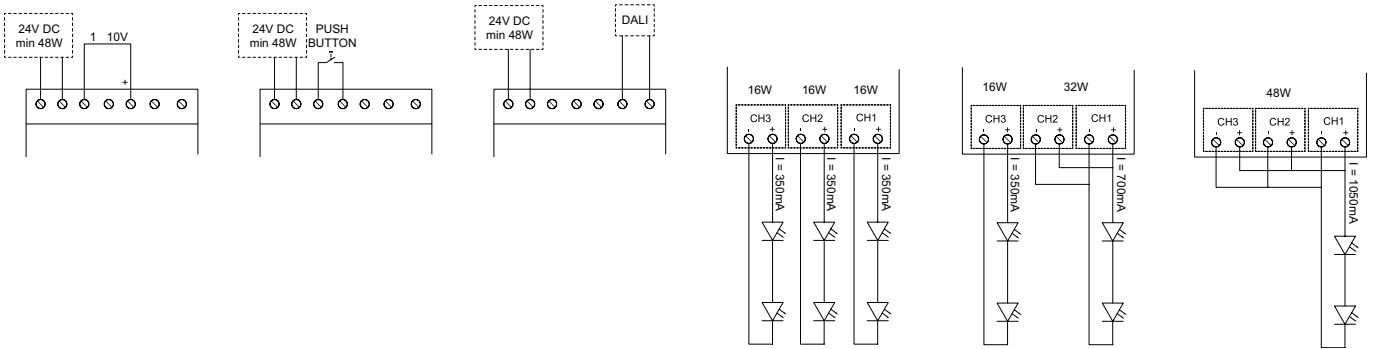

Transfo 50W

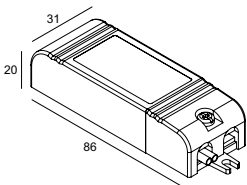

TRANSFO 50W
200 46 06
220-240V / 50-60Hz

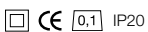

Transfo 100W

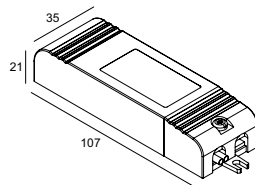

TRANSFO 100W
200 46 10
220-240V / 50-60Hz

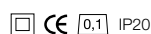

Ballastset C50 20

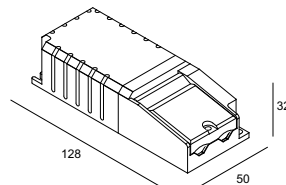

BALLASTSET C50 20 4,0 kV
200 44 21
IGNITION TENSION 4,0 kV
220-240V / 50-60Hz / 1 x 1-EVG

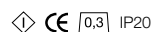

Ballastset C50 35

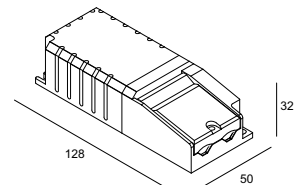

BALLASTSET C50 35 4,0 kV
200 44 36
IGNITION TENSION 4,0 kV
220-240V / 50-60Hz / 1 x 1-EVG

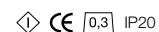

Plasterkit

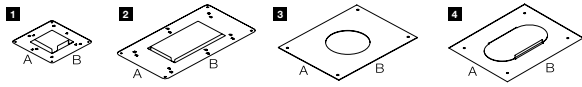

PLASTERKIT	REFERENCE	A x B	□	○	[KG]	L	S1		S2		TYPE
							min. - max.	min. - max.	min. - max.	min. - max.	
PLASTERKIT 104	202 14 29	219 x 225		75 - 79 - 75	0.1	160 x 190					4
PLASTERKIT 118	202 56 99 01	280 x 280		163	0.3	220 x 220					3
PLASTERKIT 120	202 62 99 01	260 x 230	166 x 161		0.2	190 x 170					2
PLASTERKIT 121	202 62 99 02	260 x 399	166 x 298		0.4	190 x 310					2
PLASTERKIT 161	207 01 161	200 x 200	75 x 75		0.2	175 x 175	185 - 200		110 - 200		1
PLASTERKIT 164	207 01 164	230 x 230		105	0.2	200 x 200					3
PLASTERKIT 189	207 01 189	247 x 160	77 x 105		0.2	110 x 190					2

Concrete Box

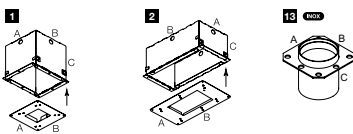

CONCRETE BOX	REFERENCE	A x B x C	[KG]	L	H	TYPE
CONCRETE BOX 120	202 62 98 01	230 x 260 x 120	1.3	235 x 265	130	1
CONCRETE BOX 121	202 62 98 02	260 x 399 x 120	2.2	265 x 405	130	2
CONCRETE BOX 161	270 11 161	202 x 202 x 186	0.6	207 x 207	196	1
CONCRETE BOX 188	270 11 188	Ø60 x 65	0.5	Ø67	70	18
CONCRETE BOX 189	270 11 189	160 x 247 x 76	0.5	165 x 255	85	2

Mounting Kit

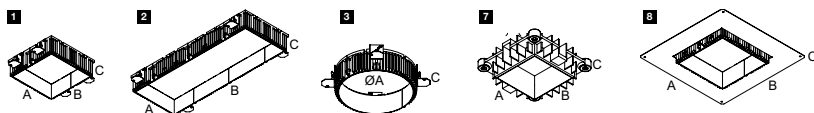

MOUNTING KIT	REFERENCE	A x B x C	[KG]	Hollow material		Solid material	Option/ Requirement	TYPE
				L	H			
GRID IN TRIMLESS 1 MOUNTING KIT HP	202 61 95 01 HP	171 x 171 x 55	0.40	173 x 173	max.25		R	1
GRID IN TRIMLESS 2 MOUNTING KIT HP	202 61 95 02 HP	171 x 310 x 55	0.70	312 x 173	max.25		R	2
MOUNTING KIT 75	202 00 75	117 x 117 x 30	0.10		9 or 12		O	7
MOUNTING KIT 75 TRIMLESS	202 01 75	117 x 117 x 30	0.10		9 or 12		R	7
MOUNTING KIT 75 TRIMLESS O.F.A.	202 01 75 OFA	240 x 240 x 40	0.20			Ø182	R	8
MOUNTING KIT FLUSH	400 90 01	118 x 118	0.20		12		R	3
MOUNTING KIT R102 TRIMLESS O.F.A.	400 91 02 OFA	195 x 195 x 155	0.20			Ø132	R	3
MOUNTING KIT R82 TRIMLESS O.F.A.	202 11 82 OFA	200 x 200 x 44	0.20		max.25	Ø122	R	3

Genie Box 90 R

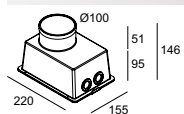

L 224 x 159 x 150
GENIE BOX 90 R
213 19 09

INCL. 1 x BASE PLATE
EXCL. TRANSFO
max.500kg

[0,6]

CBox

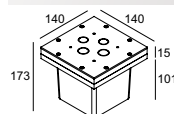

L 142 x 142 x 300
CBOX
216 12 00

INCL. 2 x PG13,5 / 1 x PG11

[0,5] IP67

IP68 Connection Kit

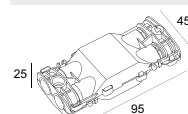

IP68 CONNECTION KIT
216 12 01

CABLE Ø7,5-10 mm
MAX.3 x 4mm²
4A 250V

[0,1] IP68

IP68 Connector 3P

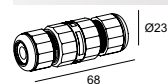

IP68 CONNECTOR 3P
216 12 02

CABLE Ø7,5-12 mm
MAX.3 x 1,5mm²
4A 250V

[0,1] IP68



Haloled

Flatpoint

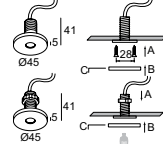
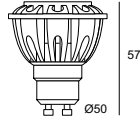
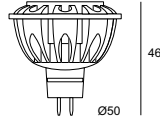
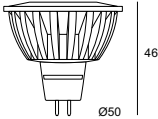

HALOLED 51 - 36° (20W) WW
309 106 38 22
 INCL.1 x POWERLED WHITE / 3000K ●
 INCL.1 x LENS 36°
 TOTAL POWER 5W/210lm
 GX5.3 / 12V

CE 0,1 IP20

HALOLED 51 - 36° (35W) WW
309 106 38 32
 INCL.1 x POWERLED WHITE / 3000K ●
 INCL.1 x LENS 36°
 TOTAL POWER 7W/315lm
 GX5.3 / 12V

CE 0,1 IP20

HALOLED Hi - 36° (35W) WW
309 107 38 32
 INCL.3 x POWERLED WHITE / 2700K ●
 INCL.3 x LENS 35°
 TOTAL POWER 5,2W/190lm
 GU10 / 220-240V / 50-60Hz

CE 0,1 IP20

16 x 60
FLATPOINT ◇
203 10 06 ◇
 ◇ = ALU / **W**
 EXCL.1 x JAC ****
 12V / EXCL.TRANSFO

◇ 0,1 IP20

Cable Base R

Cable Base S

Coverset R

Coverset S

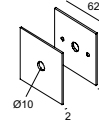
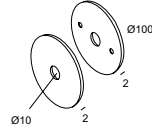
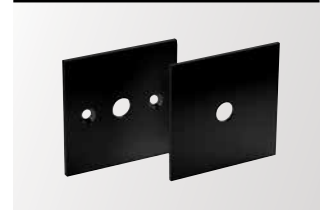
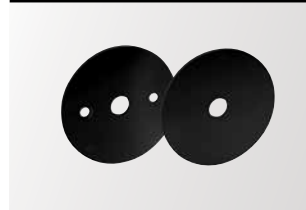

CABLE BASE R ◇
203 99 55 ◇
 ◇ = ANO / B / W

0,1

OPTIONS
 COVERSSET R 62-90-100

CABLE BASE S ◇
203 99 56 ◇
 ◇ = ANO / B / W

0,1

OPTIONS
 COVERSSET S 62-80-90

COVERSET R 100 ◇
204 00 100 ◇
COVERSET R 62 ◇
204 00 62 ◇
COVERSET R 90 ◇
204 00 90 ◇
 ◇ = ANO / W / **B**

0,1

COVERSET S 62 ◇
204 62 62 ◇
COVERSET S 80 ◇
204 80 80 ◇
COVERSET S 90 ◇
204 90 90 ◇
 ◇ = ANO / W / **B**

0,1

Clip 50

Dicroic Filter 50









































CLIP 50 ◇
201 30 98 ◇
 ◇ = A / B / W

0,1































DICROIC FILTER 50 BLUE
201 30 11
DICROIC FILTER 50 GREEN
201 30 12
DICROIC FILTER 50 RED
201 30 13
DICROIC FILTER 50 YELLOW
201 30 14

0,1 max. 20W

Lamp Index

LIGHTSOURCE	LAMP	FITTING	VOLTAGE	OUTPUT (W)
	A60	E27Ls	100-240V / 50-60Hz	15-25-40-60
	QR-CBC35	G4	12V	20-35
	QR-51 ALU	GX5.3	12V	20-35-50
	QR-C51	GX5.3	12V	20-35-50
	QR-CBC51	GX5.3	12V	20-35-50
	QR-CB51	GX5.3	12V	20-35-50
	QR-LP70	BA15d	12V	20-50
	QR-LP111	G53	12V	35-50-75-100
	QT9	G4	12V	5-10-20
	QT12	GY6.35	12V	20-35-50
	QT14	G9	100-240V / 50-60Hz	25-40-60
	QT32	E27Ls	100-240V / 50-60Hz	70
	QT-DE12	R7s	100-240V / 50-60Hz	150
	QT-DE12s	R7s	100-240V / 50-60Hz	100-150
	QPAR51	GU10	100-240V / 50-60Hz	35-50
	QPAR30	E27Ls	100-240V / 50-60Hz	75
	HIT-TC	G8.5	220-240V / 50-60Hz	35-50-70
	HIT-TC CE	PGJ5	220-240V / 50-60Hz	20
	HIT	G12	220-240V / 50-60Hz	35-70-150
	HIT-CE-od	PGZ18	220-240V / 50-60Hz	210
	HIT-DE	RX7s	220-240V / 50-60Hz	70-150
	HIPAR51	GX10	220-240V / 50-60Hz	20-35
	HIPAR20	E27Hs	220-240V / 50-60Hz	35
	HIPAR30	E27Hs	220-240V / 50-60Hz	35-70
	HIR- CE111	GX8.5	220-240V / 50-60Hz	35-70
	T16	G5	220-240V / 50-60Hz	8 14-21-28-35 24-39-49-54-80
	T16-S	G5	220-240V / 50-60Hz	24-39-54
	T16-R	2GX13	220-240V / 50-60Hz	22-55-60
	TC-S	G23	220-240V / 50-60Hz	9
	TC-D	G24d-1 G24d-3	220-240V / 50-60Hz	10 26
	TC-DEL	G24q-1 G24q-2 G24q-3	220-240V / 50-60Hz	13 18 26
	TC-T	GX24d-2	220-240V / 50-60Hz	18
	TC-TEL	GX24q-2 GX24q-3 GX24q-4	220-240V / 50-60Hz	18 26-32 42
	TC-L	2G11	220-240V / 50-60Hz	18-24-36-55
	T2-MLF	GX53	220-240V / 50-60Hz	9
	TC-DSE	E14	100-240V / 50-60Hz	11-12
	TC-TSE	E27Ls	100-240V / 50-60Hz	15-20-23
	TCA-SE	E27Ls	100-240V / 50-60Hz	5-7-10-15-20
	TC-SB	E27Ls	100-240V / 50-60Hz	9-12-16

Legenda

						
◇ A ALU ANO B C G INOX M N MMAT PRIM RAL W	KLEUR ALU GRIS ALUMINIUM GEANODISEERD ALU ZWART RAL 9005 CHROOM GRIS BRUIN ROESTVRIJ STAAL VERGULD DONKERGRIS VERGULD MAT GRONDLAAG KLEUR RAL WIT RAL 9003	COULEUR ALU GRIS ALUMINIUM ALU ANODISE NOIR RAL 9005 CHROME GRIS BRUN ACIER INOXYDABLE DORE GRIS FONCE LAITON DEPOLI APPRET COULEUR RAL BLANC RAL 9003	COLOUR ALU GREY ALUMINIUM ALU ANODISED BLACK RAL 9005 CHROMED GREY BROWN STAINLESS STEEL GOLD DARK GREY GOLD MAT PRIMER COLOUR RAL WHITE RAL 9003	FARBE ALU GRAU ALUMINIUM ALU ELOXIERT SCHWARZ RAL 9005 CHROM GRAU BRAUN ROSTFREIER STAHL GOLD DUNKELGRAU VERGOLDET MAT GRUNDIERUNG FARBE RAL WEIß RAL 9003	COLOR ALU GRIS ALUMINIO ALU ANODIZADO NEGRO RAL 9005 CROMO GRIS MARRON ACERO INOXIDABLE ORO GRIS OSCURO ORO MATE PINTURA DE FONDO COLOR RAL BLANCO RAL 9003	COLORE ALU GRIGIO ALUMINIO ALU ANODIZZATO NERO RAL 9005 CROMATO GRIGIO BRUNO ACCIAIO INOSSIDABILE ORO GRIGIO SCURO ORO OPACO MESTICA COLORE RAL BIANCO RAL 9003
	TOESTEL KLASSE 1	APPAREIL CLASSE 1	FIXTURE CLASS 1	GERÄT KLASSE 1	APARATO CLASE 1	APPARECCHIO CLASSE 1
	TOESTEL KLASSE 2	APPAREIL CLASSE 2	FIXTURE CLASS 2	GERÄT KLASSE 2	APARATO CLASE 2	APPARECCHIO CLASSE 2
	TOESTEL KLASSE 3	APPAREIL CLASSE 3	FIXTURE CLASS 3	GERÄT KLASSE 3	APARATO CLASE 3	APPARECCHIO CLASSE 3
	NORM 01.96 EMC 89 / 336 / EEC	NORM 01.97. LV 73 / 23 / EEC				
	NETTO GEWICHT KG	POIDS NET KG	NET WEIGHT KG	NETTO GEWICHT KG	PESO NETO KG	PESO NETTO KG
IP..	BESCHERMINGSINDICATIE	INDICE DE PROTECTION	PROTECTION LEVEL	SCHUTZKLASSE	CLASE DE PROTECCIÓN	CLASSE DI PROTEZIONE
	RONDE OPENING DIAMETER x MIN. INBOUWDEPTE	DECOUPE RONDE DIAMETRE x PROFONDEUR NECESSAIRE POUR ENCASTREMENT	ROUND OPENING DIAMETER x MIN. DEPTH FOR RECESSING	RUNDE ÖFFNUNG DIAMETER x MIN. TIEFE FÜR EINBAU	ABERTURA REDONDA DIAMETRO x DISTANCIA MINIMA DE EMPOTRAMIENTO	FORO TONDO DIAMETRO x SPESORE MINIMO RICHIESTO PER L'INCASSO
	RECHTHOEKIGE OPENING LENGTE x BREEDTE x MIN. INBOUWDEPTE	DECOUPE RECTANGULAIRE LO x LA x PRO. NECESSAIRE POUR ENCASTREMENT	RECTANGULAR OPENING LENGTH x WIDTH x MINIMUM DEPTH FOR RECESSING	RECHTECKIGE ÖFFNUNG LÄNGE x BREITE x MINIMUM TIEFE EINBAU	ABERTURA RECTANGULAR LARGO x ANCHO x DISTANCIA MINIMA DE EMPOTRAMIENTO	FORO RETTANGOLARE LUNGHEZZA x LARGHEZZA x SPESORE MINIMO RICHIESTO PER L'INCASSO
	MAX. DIKTE MONTAGEOPPERVLAK	EPAISSEUR MAX. DE LA SURFACE DE MONTAGE	MAX. THICKNESS OF THE MOUNTING SURFACE	MAXIMALE STÄRKE DER BEFESTIGUNGSFLÄCHE	ESPOSOR MÁXIMO DE LA SUPERFICIE DE MONTAJE	SPESORE MASSIMO DELLA SUPERFICIE DI MONTAGGIO
	MIN. AFSTAND (M) LAMP - OBJECT	DISTANCE MIN. (M) AMPOULE - OBJET	MIN. DISTANCE (M) LAMP - OBJECT	MIN. DISTANZ (M) LAMPPE - OBJEKT	DISTANCIA MINIMA (M) LÁMPARA - OBJETO	DISTANZA MIN. (M) LAMPADA - OGGETTO
	BEVESTIGING VLOER - WAND - PLAFOND OPBOUW	MONTAGE SOL - MUR - PLAFOND APPLIQUE	FIXATION FLOOR - WALL - CEILING SURFACE MOUNTED	MONTAGE BODEN - WAND - DECKE AUFGEBAUT	MONTAJE SUELO - PARED- TECHO MONTADO AL SUPERFICIE	MONTAGGIO PAVIMENTO-PARETE - SOFFITTO MONTATO A SUPERFICIE
	BEVESTIGING VLOER - WAND - PLAFOND INBOUW	MONTAGE SOL - MUR - PLAFOND ENCASTRE	FIXATION FLOOR - WALL - CEILING RECESSED	MONTAGE BODEN - WAND - DECKE EINGEBAUT	MONTAJE SUELO - PARED-TECHO EMPOTRADO	MONTAGGIO PAVIMENTO-PARETE - SOFFITTO-INCASSO
	BEVESTIGING PLAFOND GEPENDELD	MONTAGE PLAFOND SUSPENDU	FIXATION CEILING SUSPENDED	MONTAGE DECKE GEPENDELT	MONTAJE TECHO SUSPENDIDO	MONTAGGIO SOFFITTO SOSPESO
	STAND ALONE	STAND ALONE	STAND ALONE	STAND ALONE	STAND ALONE	STAND ALONE
	GESCHIKT VOOR BINNEN- EN BUITENGEBRUIK	CONVIENT A USAGE INTERIEUR ET EXTERIEUR	SUITABLE FOR INDOOR AND OUTDOOR USE	EIGNET SICH FÜR INNEN- UND AUSSENBEREICH	APTO PARA USO INTERIOR Y EXTERIOR	PER UTILIZZO SIA IN INTERNI CHE DA ESTERNI
	VEREN VOOR HOLLE WAND	RESSORTS PRECONISES POUR FAUX-PLAFONDS	SPRINGS FOR HOLLOW SURFACES	FEDERN FÜR HOHL- RAUMDECKE	MUELLES PARA UTILIZAR EN FALSOS TECHOS DE ESCAYOLA Y PLADUR	SISTEMA DI FISSAGGIO PER CONTRO- SOFFITTI IN LASTRE O PANNELLI
	VEREN VOOR VOLLE WAND	RESSORTS PRECONISES POUR PLAFONDS STANDARDS	SPRINGS FOR SOLID SURFACES	FEDERN FÜR VOLL- MATERIAL	MUELLES PARA UTILIZAR EN HORMIGON	SISTEMA DI FISSAGGIO PER VANI CHIUSI REALIZZATI NELLA MURATURA
BAP	LAAGLUMINANTIERASTER	DIFFUSEUR ANTI - REFLETS SPECIAL INFORMATIQUE	CATEGORY II LOUVER	BAP RASTER	REFLECTOR DE BAJA LUMINANCIA	RIFLETTORE A BASSA LUMINANCIA
	ELEKTRONISCHE TRANSFORMATOR	TRANSFORMATEUR ELECTRONIQUE	ELECTRONIC TRANSFORMER	ELEKTRONISCHER TRANSFORMATOR	TRANSFORMADOR ELECTRÓNICO	TRASFORMATORE ELETTRONICO
EXCL.TRANSFO	EXCL.TRANSFORMATOR	EXCL.TRANSFORMATEUR	EXCL.TRANSFORMER	EXCL.TRANSFORMATOR	EXCL.TRANSFORMADOR	ESCL.TRASFORMATORE
	ELEKTRONISCHE VOORSCHAKELAPPARATUUR	BALLAST ELECTRONIQUE	ELECTRONIC BALLAST	ELEKTRONISCHES VORSCHALTGERÄT	BALASTRO ELECTRONICO	REATTORE ELETTRONICO
	DIMBAAR ELEKTRONISCHE VOORSCHAKELAPPARATUUR	BALLAST ELECTRONIQUE DIMMABLE	ELECTRONIC DIMMABLE BALLAST	ELEKTRONISCHES DIMBARES VORSCHALTGERÄT	BALASTRO ELECTRONICO REGULABLE	REATTORE ELETTRONICO DIMMERABILE
	LAMBDA = 0,9	LAMBDA = 0,9	LAMBDA = 0,9	LAMBDA = 0,9	LAMBDA = 0,9	LAMBDA = 0,9
	DIMBAAR FASE AFSNID NG GEZANDSTRAALD	COUPE PHASE DESCENDANTE SABLE	FALLING EDGE DIMMABLE SANDBLASTED	PHASENABSCHNITT DIMMUNG GESANDSTRAHLTES	REGULACION DE CORTE DESCENDENTE SATINADO	REGOLAZIONE CON DIMMER A TAGLIO DI FASE SATINATO
ESG	VEILIGHEIDSGLAS	VERRE DE SECURITE	SAFETY GLASS	EINSCHBEIEN SICHERHEITSGLAS	CRISTAL DE SEGUR DAD	VETRO DI SICUREZZA
	AFMETINGEN IN MM TOLERANTIE VOLGENS DIN-NORMEN	DIMENSIONS EN MM TOLERANCE CONFORME AUX NORMES DIN	DIMENSIONS IN MM TOLERANCE ACCORDING TO DIN-SPECIFICATIONS	ABMESSUNGEN IN MM TOLERANZ NACH DIN-NORMEN	DIMENSIONES EN MM TOLERANCIA SEGUN LAS NORMAS DIN	DIMENSIONI IN MM TOLLERANZE A NORME DIN
TOL. DIN	TOLERANTIES EXTRUSIE	TOLERANCES EXTRUSION	TOLERANCES EXTRUSION	TOLERANZEN EXTRUSION	TOLERANCIAS EXTRUSION	TOLLERANZA ESTRUSIONE
DIN EN12020-2	TOLERANTIES ANODISATIE	TOLERANCES ANODISATION	TOLERANCES ANODISATION	TOLERANZEN ELOXIERUNG	TOLERANCIA ANODIZADO	TOLLERANZA ANODIZZATO
DIN 17.611	TOLERANTIES LAKWERK	TOLERANCES LAQUAGE	TOLERANCES COATING	TOLERANZEN LACKIERUNG	TOLERANCIA LACA	TOLLERANZA LACCA
	GEREGISTREERD DESIGN	MODÈLE DÉPOSÉ	REGISTERED DESIGN	REGISTRIERTES DESIGN	DISEÑO REGISTRADO	MODELLO DEPOSITATO
	LED TOESTEL	LUMINAIRE À LED	LED LUMINAIRE	LED LEUCHTE	FUENTE LED	APPARECCHIO ALIMENTATO A LED
	GESCHIKT VOOR TOEPASSING IN BADKAMERS (**)	APPLICABLE POUR SALLES DE BAINS (**)	SUITABLE FOR USE IN BATHROOM (**)	GEEIGNET FÜR INSTALLATION IM BADEZIMMER (**)	ILUMINACIÓN APTO PARA USO EN BAÑOS (**)	ILLUMINAZIONE ADATTA PER L'AMBIENTE BAGNO (**)



CECIS IS THE BELGIAN CERTIFICATION BODY IN THE FIELD OF ELECTRICAL EQUIPMENT
 IT IS PARTICIPATING IN THE CB SCHEME SINCE IT IS ACCREDITED AS A CERTIFICATION BODY FOR THE CERTIFICATION OF PRODUCTS ACCORDING TO EN 45011 AND THE CERTIFICATION OF QUALITY SYSTEMS ACCORDING TO THE STANDARD EN 45012
) CHECK COMPLIANCE WITH LOCAL REGULATIONS
 *PRODUCTS MANUFACTURED ACCORDING TO IEC/EN 60598 1 AND THE APPLICABLE SECTIONS OF IEC/EN 60598 2

Index by Name

NAME	PAG
A	
B	
BACKSPACE 38 LED	87
BACKSPACE 66 LED	87
BALLASTSET C50 20 4,0 kV	TEC 11
BALLASTSET C50 35 4,0 kV	TEC 11
B-LINER 6522 IP	113
B-LINER 6532 IP	113
B-LINER 6542 IP	113
BOOSTER HP 3027	77
BOOSTER HP 3027 AD	95
BOOSTER HP 3027 AD DIM 5	95
BOOSTER HP 3050	77
BOOSTER HP 3050 AD	95
BOOSTER HP 3050 AD DIM 5	95
C	
CABLE BASE R	TEC 13
CABLE BASE S	TEC 13
CARREE 150 LED S1	69
CARREE RS LED 2733 S1	67
CARREE RS LED 2733-9 S1	67
CARREE RS LED 3033 S1	67
CARREE RS LED 3033-9 S1	67
CARREE SC OK 2733 S1	65
CARREE SC OK 2733 S2	65
CARREE SC OK 2733-9 S1	65
CARREE SC OK 2733-9 S2	65
CARREE SC OK 3033 S1	65
CARREE SC OK 3033 S2	65
CARREE SC OK 3033-9 S1	65
CARREE SC OK 3033-9 S2	65
CARREE ST OK LED 2733 S1	63
CARREE ST OK LED 2733 S2	63
CARREE ST OK LED 2733-9 S1	63
CARREE ST OK LED 2733-9 S2	63
CARREE ST OK LED 3033 S1	63
CARREE ST OK LED 3033 S2	63
CARREE ST OK LED 3033-9 S1	63
CARREE ST OK LED 3033-9 S2	63
CARREE TRIMLESS OK LED 2733 S1	61
CARREE TRIMLESS OK LED 2733-9 S1	61
CARREE TRIMLESS OK LED 3033 S1	61
CARREE TRIMLESS OK LED 3033-9 S1	61
CARREE X LED 3033-65 S1	129
CARREE X LED 3033-65 S2	129
CBOX	TEC 12
CLIP 50	TEC 13
CONCRETE BOX 120	TEC 12
CONCRETE BOX 121	TEC 12
CONCRETE BOX 161	TEC 12
CONCRETE BOX 188	TEC 12
CONCRETE BOX 189	TEC 12
CONNECTION TRIMLESS O.F.A.	130
COVERSET R 100	TEC 13
COVERSET R 62	TEC 13
COVERSET R 90	TEC 13
COVERSET S 62	TEC 13
COVERSET S 80	TEC 13
COVERSET S 90	TEC 13
D	
DIRO DUO ST OK LED 2733 S1	59
DIRO DUO ST OK LED 2733-9 S1	59
DIRO DUO ST OK LED 3033 S1	59
DIRO DUO ST OK LED 3033-9 S1	59
DIRO TRIMLESS LED 2733	59
DIRO TRIMLESS LED 2733-9	59
DIRO TRIMLESS LED 3033	59
DIRO TRIMLESS LED 3033-9	59
E	

NAME	PAG
F	
FLATPOINT	TEC 13
FNL - PROFILE	102
FORTY-5 L	85
FORTY-5 R	85
G	
GABOO C	81
GABOO W	81
GENIE BOX 90 R	TEC 12
GLASS SBL 40	135
GLASS SBL 50	51
GLASS SBL 70	137
GLASS SBL 87	133
GRID IN 1 HP 303027	73
GRID IN 1 HP 303027-9	73
GRID IN 1 HP 303050	73
GRID IN 1 HP 303050-9	73
GRID IN 2 HP 303027	73
GRID IN 2 HP 303027-9	73
GRID IN 2 HP 303050	73
GRID IN 2 HP 303050-9	73
GRID IN TRIMLESS 1 HP 303027	71
GRID IN TRIMLESS 1 HP 303027-9	71
GRID IN TRIMLESS 1 HP 303050	71
GRID IN TRIMLESS 1 HP 303050-9	71
GRID IN TRIMLESS 1 MOUNTING KIT HP	TEC 12
GRID IN TRIMLESS 2 HP 303027	71
GRID IN TRIMLESS 2 HP 303027-9	71
GRID IN TRIMLESS 2 HP 303050	71
GRID IN TRIMLESS 2 HP 303050-9	71
GRID IN TRIMLESS 2 MOUNTING KIT HP	TEC 12
H	
HALOLED 51 - 36° (20W) WW	TEC 13
HALOLED 51 - 36° (35W) WW	TEC 13
HALOLED Hi - 36° (35W) WW	TEC 13
HONEYCOMB 40	134
HONEYCOMB 50	50
HONEYCOMB 70	136
HONEYCOMB 78	131
HONEYCOMB 87	132
HONEYCOMB OK LED 2733-9 S1	138
HONEYCOMB KIX	
I	
iMAX® 50	25
iMAX® 50Hi	25
iMAX® ADJUSTABLE 50	33
iMAX® ADJUSTABLE 50Hi	33
iMAX® ADJUSTABLE BL4 82710	29
iMAX® ADJUSTABLE BL4 83010	29
iMAX® ADJUSTABLE BL4 92710	29
iMAX® ADJUSTABLE BL4 93010	29
iMAX® ADJUSTABLE BR20 82729	29
iMAX® ADJUSTABLE BR20 82743	29
iMAX® ADJUSTABLE BR20 83029	29
iMAX® ADJUSTABLE BR20 83043	29
iMAX® ADJUSTABLE BR20 92729	29
iMAX® ADJUSTABLE BR20 92743	29
iMAX® ADJUSTABLE BR20 93029	29
iMAX® ADJUSTABLE BR20 93043	29
iMAX® ADJUSTABLE BR8 82729	29
iMAX® ADJUSTABLE BR8 82743	29
iMAX® ADJUSTABLE BR8 83029	29
iMAX® ADJUSTABLE BR8 83043	29
iMAX® ADJUSTABLE BR8 92729	29
iMAX® ADJUSTABLE BR8 92743	29
iMAX® ADJUSTABLE BR8 93029	29
iMAX® ADJUSTABLE BR8 93043	29
iMAX® ADJUSTABLE CL 82706	31
iMAX® ADJUSTABLE CL 83006	31
iMAX® ADJUSTABLE CL 92706	31
iMAX® ADJUSTABLE CL 93006	31
iMAX® ADJUSTABLE TRIMLESS 50	41
iMAX® ADJUSTABLE TRIMLESS 50Hi	41

NAME	PAG
iMAX® ADJUSTABLE TRIMLESS BL4 82710	37
iMAX® ADJUSTABLE TRIMLESS BL4 83010	37
iMAX® ADJUSTABLE TRIMLESS BL4 92710	37
iMAX® ADJUSTABLE TRIMLESS BL4 93010	37
iMAX® ADJUSTABLE TRIMLESS BR20 82729	37
iMAX® ADJUSTABLE TRIMLESS BR20 82743	37
iMAX® ADJUSTABLE TRIMLESS BR20 83029	37
iMAX® ADJUSTABLE TRIMLESS BR20 83043	37
iMAX® ADJUSTABLE TRIMLESS BR20 92729	37
iMAX® ADJUSTABLE TRIMLESS BR20 92743	37
iMAX® ADJUSTABLE TRIMLESS BR20 93029	37
iMAX® ADJUSTABLE TRIMLESS BR20 93043	37
iMAX® ADJUSTABLE TRIMLESS BR8 82729	37
iMAX® ADJUSTABLE TRIMLESS BR8 82743	37
iMAX® ADJUSTABLE TRIMLESS BR8 83029	37
iMAX® ADJUSTABLE TRIMLESS BR8 83043	37
iMAX® ADJUSTABLE TRIMLESS BR8 92729	37
iMAX® ADJUSTABLE TRIMLESS BR8 92743	37
iMAX® ADJUSTABLE TRIMLESS BR8 93029	37
iMAX® ADJUSTABLE TRIMLESS BR8 93043	37
iMAX® ADJUSTABLE TRIMLESS C50	41
iMAX® ADJUSTABLE TRIMLESS CL 82706	39
iMAX® ADJUSTABLE TRIMLESS CL 83006	39
iMAX® ADJUSTABLE TRIMLESS CL 92706	39
iMAX® ADJUSTABLE TRIMLESS CL 93006	39
iMAX® ADJUSTABLE TRIMLESS XR13 82743	39
iMAX® ADJUSTABLE TRIMLESS XR13 83043	39
iMAX® ADJUSTABLE TRIMLESS XR13 92743	39
iMAX® ADJUSTABLE TRIMLESS XR13 93043	39
iMAX® ADJUSTABLE XR13 82743	31
iMAX® ADJUSTABLE XR13 83043	31
iMAX® ADJUSTABLE XR13 92743	31
iMAX® ADJUSTABLE XR13 93043	31
iMAX® BL4 82710	21
iMAX® BL4 83010	21
iMAX® BL4 92710	21
iMAX® BL4 93010	21
iMAX® BR20 82729	21
iMAX® BR20 82743	21
iMAX® BR20 83029	21
iMAX® BR20 83043	21
iMAX® BR20 92729	21
iMAX® BR20 92743	21
iMAX® BR20 93029	21
iMAX® BR20 93043	21
iMAX® BR8 82729	21
iMAX® BR8 82743	21
iMAX® BR8 83029	21
iMAX® BR8 83043	21
iMAX® BR8 92729	21
iMAX® BR8 92743	21
iMAX® BR8 93029	21
iMAX® BR8 93043	21
iMAX® C50	25
iMAX® CL 82706	23
iMAX® CL 83006	23
iMAX® CL 92706	23
iMAX® CL 93006	23
iMAX® COVER ROUND	14
iMAX® COVER ROUND FLUSH	14
iMAX® COVER ROUND IP	14
iMAX® COVER ROUND TRIMLESS	15
iMAX® COVER ROUND WALLWASH	15
iMAX® COVER SQUARE	15
iMAX® GLASS SBL	17
iMAX® HONEYCOMB	16
iMAX® LINEAR SPREAD LENS	16
iMAX® SOFTENING LENS	17
iMAX® SPREAD LENS	17
iMAX® TUBE	20
iMAX® WALLWASH BR8 82729	45
iMAX® WALLWASH BR8 82743	45
iMAX® WALLWASH BR8 83029	45
iMAX® WALLWASH BR8 83043	45
iMAX® WALLWASH BR8 92729	45
iMAX® WALLWASH BR8 92743	45
iMAX® WALLWASH BR8 93029	45
iMAX® WALLWASH BR8 93043	45
iMAX® WALLWASH XR13 82743	45
iMAX® WALLWASH XR13 83043	45

Index by Name

NAME	PAG	NAME	PAG	NAME	PAG																	
IMAX® WALLWASH XR13 92743	45	M	MINI SPY	53	TRACK DIM CORNER 180°	88																
IMAX® WALLWASH XR13 93043	45		MOMBA DOWN-UP LED SP WW	117	TRACK DIM CORNER 60° - 300°	88																
IMAX® XR13 82743	23		MOMBA LED SP WW	117	TRACK DIM CORNER 90° IN	88																
IMAX® XR13 83043	23		MOUNTING KIT 75	TEC 12	TRACK DIM CORNER 90° OUT	88																
IMAX® XR13 92743	23		MOUNTING KIT 75 TRIMLESS	TEC 12	TRACK DIM DIRECT FIXATION	89																
IMAX® XR13 93043	23		MOUNTING KIT 75 TRIMLESS O.F.A.	TEC 12	TRACK DIM END CAP	88																
IMAX®+ BL4 82710	49		MOUNTING KIT FLUSH R102	TEC 12	TRACK DIM END SUPPLY 11	88																
IMAX®+ BL4 83010	49		MOUNTING KIT R102 TRIMLESS O.F.A.	TEC 12	TRACK DIM END SUPPLY 12	88																
IMAX®+ BL4 92710	49		MOUNTING KIT R82 TRIMLESS O.F.A.	TEC 12	TRACK DIM MIDDLE SUPPLY	88																
IMAX®+ BL4 93010	49		MOUNTING SET S2	20	TRACK DIM SUSPENSION 3.0	89																
IMAX®+ BR8 82729	49		N	OPTO CLIP	131	TRANSFO 100W	TEC 11															
IMAX®+ BR8 82743	49				O	TRANSFO 50W	TEC 11	TWEETER CLIP	134													
IMAX®+ BR8 83029	49						P	PITCH 162	75	U												
IMAX®+ BR8 83043	49								PITCH 162 RECESSED KIT		75	V										
IMAX®+ BR8 92729	49								PLASTERKIT 104		TEC 12		W									
IMAX®+ BR8 92743	49								PLASTERKIT 118		TEC 12			X								
IMAX®+ BR8 93029	49								PLASTERKIT 120		TEC 12				Y							
IMAX®+ BR8 93043	49								PLASTERKIT 121		TEC 12					YOU-TURN ON OPTO 202715 AD DIM 1	93					
IMAX®+ CL 82706	49								PLASTERKIT 161		TEC 12					YOU-TURN ON OPTO 202715 AD DIM 5	93					
IMAX®+ CL 83006	49								PLASTERKIT 164		TEC 12					YOU-TURN ON OPTO 202715-9 AD DIM 1	93					
IMAX®+ CL 92706	49	PLASTERKIT 189							TEC 12		YOU-TURN ON OPTO 202715-9 AD DIM 5					93						
IMAX®+ CL 93006	49	POGO							83		YOU-TURN ON OPTO 202733 AD DIM 1					93						
IP68 CONNECTION KIT	TEC 12	Q							RAND 1 LED DIM8		127					YOU-TURN ON OPTO 202733-9 AD DIM 1	93					
IP68 CONNECTOR 3P	TEC 12										RAND 2 LED DIM8					127	YOU-TURN ON OPTO 202733-9 AD DIM 5	93				
J											R					RAND 3 LED DIM8	127	YOU-TURN ON OPTO 202755 AD DIM 1	93			
																REO X 3033-65 S1	129	YOU-TURN ON OPTO 202755-9 AD DIM 5	93			
																REO X 3033-65 S2	129	YOU-TURN ON OPTO 203015 AD DIM 1	93			
																K		S	SOFTENING LENS 40	135	YOU-TURN ON OPTO 203015 AD DIM 5	93
																			SOFTENING LENS 50	51	YOU-TURN ON OPTO 203033 AD DIM 1	93
																			SOFTENING LENS 70	137	YOU-TURN ON OPTO 203033-9 AD DIM 5	93
			SOFTENING LENS 78	131															YOU-TURN ON OPTO 203055 AD DIM 1	93		
			SOFTENING LENS 87	133	YOU-TURN ON OPTO 203055-9 AD DIM 5	93																
			SPREAD LENS 40	135	YOU-TURN ON OPTO 203055-9 AD DIM 1	91																
			SPREAD LENS 50	51	YOU-TURN ON OPTO 203055-9 AD DIM 5	93																
			SPREAD LENS 70	137	YOU-TURN ON OPTO 203055-9 AD DIM 1	91																
			SPREAD LENS 87	133	YOU-TURN ON OPTO 203055-9 AD DIM 5	93																
			SPY ST 2733	55	YOU-TURN ON REO 202733 AD DIM 1	91																
			SPY ST 2733-9	55	YOU-TURN ON REO 202733-9 AD DIM 5	91																
			SPY ST 3033	55	YOU-TURN ON REO 202733-9 AD DIM 1	91																
			SPY ST 3033-9	55	YOU-TURN ON REO 202750 AD DIM 1	91																
			SPY TRIMLESS 2733	55	YOU-TURN ON REO 202750 AD DIM 5	91																
			SPY TRIMLESS 2733-9	55	YOU-TURN ON REO 202750-9 AD DIM 1	91																
		SPY TRIMLESS 3033	55	YOU-TURN ON REO 202750-9 AD DIM 5	91																	
		SPY TRIMLESS 3033-9	55	YOU-TURN ON REO 203033 AD DIM 1	91																	
SPY TUBE	54	YOU-TURN ON REO 203033 AD DIM 5	91																			
SUPERDOME E27	79	YOU-TURN ON REO 203033-9 AD DIM 1	91																			
SUPERDOME LED EVG DIM1	79	YOU-TURN ON REO 203033-9 AD DIM 5	91																			
SUPERNOVA XS PIVOT 330 AD DIM 1	97	YOU-TURN ON REO 203050 AD DIM 1	91																			
SUPERNOVA XS PIVOT 330 AD DIM 5	97	YOU-TURN ON REO 203050 AD DIM 5	91																			
SUSPENSION + CONNECTION TRIMLESS O.F.A.	130	YOU-TURN ON REO 203050-9 AD DIM 1	91																			
SUSPENSION TRIMLESS O.F.A.	130	YOU-TURN ON REO 203050-9 AD DIM 5	91																			
L		T	TACTIC BOX 60 R	120	Z																	
			TACTIC WALLWASH	121																		
			TACTIC WALLWASH SBL	121																		
			TRACK CURRENT SUPPLY 5 x 0,75mm ² 3,0m	89																		
			TRACK DIM 1m	88																		
			TRACK DIM 2m	88																		
			TRACK DIM 3m	88																		
			LED POWER CONVERTOR																			
			24V-DC TO MULTI CURRENT 48W DIM9	TEC 11																		
			LED POWER SUPPLY 24V-DC / 150W	TEC 10																		
			LED POWER SUPPLY 24V-DC / 20W	TEC 10																		
			LED POWER SUPPLY 24V-DC / 40W	TEC 10																		
			LED POWER SUPPLY 24V-DC / 60W	TEC 10																		
			LED POWER SUPPLY 24V-DC / 60W DIN	TEC 10																		
			LED POWER SUPPLY 24V-DC / 80W DIM 1	TEC 10																		
			LED POWER SUPPLY 350mA-DC / 15W	TEC 5																		
			LED POWER SUPPLY 350mA-DC / 16W DIM8	TEC 5																		
			LED POWER SUPPLY 350mA-DC / 17W	TEC 5																		
			LED POWER SUPPLY 350mA-DC / 18W	TEC 5																		
			LED POWER SUPPLY 350mA-DC / 6W	TEC 5																		
LED POWER SUPPLY 500mA-DC / 20W	TEC 5																					
LED POWER SUPPLY 500mA-DC / 32W DIM8	TEC 5																					
LED POWER SUPPLY 500mA-DC / 6W	TEC 5																					
LED POWER SUPPLY 700mA-DC / 12W	TEC 6																					
LED POWER SUPPLY 700mA-DC / 17W	TEC 6																					
LED POWER SUPPLY 700mA-DC / 32W DIM8	TEC 6																					
LED POWER SUPPLY 700mA-DC / 36W DIM8	TEC 6																					
LED POWER SUPPLY																						
MULTI POWER 600-700mA-DC / 35W DIM 2	70																					
LED POWER SUPPLY																						
MULTI POWER 600-700mA-DC / 38W	70																					
LED POWER SUPPLY MULTI-POWER	TEC 6																					
LED POWER SUPPLY MULTI-POWER DIM1	TEC 7																					
LED POWER SUPPLY MULTI-POWER DIM6	TEC 7																					
LED POWER SUPPLY MULTI-POWER DIM7	TEC 8																					
LED POWER SUPPLY MULTI-POWER DIM9	TEC 8																					
LINEAR SPREAD LENS 40	135																					
LINEAR SPREAD LENS 50	50																					
LINEAR SPREAD LENS 70	137																					
LINEAR SPREAD LENS 87	133																					
LOGIC F1	119																					
LOGIC F2	119																					
LOGIC MINI W R	115																					
LOGIC MINI W S	115																					
LOGIC R A 3011	129																					
LOGIC R A 3030	129																					
LOGIC R A 3055	129																					
LOGIC R A WALLWASH	121																					
LOGIC R A WALLWASH SBL	121																					
LOGIC R WALLWASH	121																					
LOGIC R WALLWASH SBL	121																					



photo by Stephan Vanfleteren

The lighting industry is evolving and growing at very high speed. As a family run business we have a personal stake in keeping our clients happy. As such we are committed to making a difference through original designs, outstanding service levels, eye for detail and personal contact, striving to be the best in all we do.

Our product development process is based on a combination of creativity and technological innovation. It's our mission to present the world a portfolio of lighting designs that satisfy people's desires and needs, creating a perfect symbiosis between architecture, function and atmosphere.

Delta Light®'s success is built on the determination, passion and talent of our global team. We hereby thank all our colleagues and partners for their invaluable work.

a family business.

Manufacturer Delta Light® nv

Product Design - Research - Development: Delta Light® Team & Nice 2C
Coordination - Concept: Delta Light® Team & Nice 2C
Graphic Design - Realisation: Delta Light® Team & Nice 2C

Finally, to everyone who contributed in some way to the realisation of The Lighting Bible® 10 New Collection... **Thanks.**
www.deltalight.com/credits

Copyright © Delta Light® nv
First Edition 04-2014

Made in Belgium

For further technical info or errata, please visit www.deltalight.com

All information in this catalog is without engagement, replaces all preceding information and can always be modified.
All Delta Light® products are supplied without lamps.
Lamp data are given as example.

Delta Light® n.v. has the right to change at any time the technical aspects of its products without foregoing communication.

The Delta Light® n.v. terms and conditions are always applicable.
No part of this catalog may be copied without written authorisation of Delta Light® n.v.

Innovative use of combined heat and power technology when printing this product reduced CO₂ emissions by up to 52% in comparison to conventional methods in Germany.



Headquarters
Delta Light® nv
 Muizelstraat 2
 B-8560 Wevelgem (Moorsele)
 Belgium
 Phone: +32 (0)56 435 735
 Fax: +32 (0)56 435 736
 E-mail: info@deltalight.com
 www.deltalight.com

CONTACT DETAILS
www.deltalight.com/contacts



- ANTIGUA AND BARBUDA
- ARGENTINA
- ARMENIA
- ARUBA
- AUSTRALIA
- AZERBAIJAN
- BAHRAIN
- BELARUS
- BELGIE
- BOSNIA AND HERZEGOVINA
- BRAZIL
- BULGARIA
- CAMBODIA
- CANADA
- CHILE
- COLOMBIA
- CONGO
- COSTA RICA
- CÔTE D'IVOIRE
- CROATIA
- CYPRUS
- CZECH REPUBLIC
- DENMARK
- DEUTSCHLAND
- DOMINICAN REPUBLIC
- EGYPT
- EL SALVADOR
- ESTONIA
- ETHIOPIA
- FINLAND
- FRANCE
- GEORGIA
- GHANA
- GREECE
- GUADELOUPE
- GUATEMALA
- HONG KONG
- HUNGARY
- ICELAND
- INDIA
- INGUSHETIA
- IRAN
- ISRAEL
- ITALIA
- JAPAN
- JORDAN
- KAZAKSTAN
- KENYA
- KOSOVO
- KUWAIT
- KYRGYSTAN
- LATVIA
- LEBANON
- LITHUANIA
- LUXEMBOURG
- MACEDONIE
- MALAYSIA
- MALDIVES
- MALTA
- MAURITIUS
- MEXICO
- MOLDOVA
- MONTENEGRO
- MOROCCO
- NETHERLANDS
- NETHERLANDS ANTILLES
- NEW CALEDONIA
- NEW ZEALAND
- NIGERIA
- NORWAY
- OMAN
- PAKISTAN
- PALESTINA
- PANAMA
- PERU
- PHILIPPINES
- POLAND
- PORTUGAL
- PUERTO RICO
- QATAR
- ROMANIA
- RUSSIA
- SAINT VINCENT AND THE GRENADINES
- SAUDI ARABIA
- SERBIA
- SINGAPORE
- SLOVAKIA
- SLOVENIA
- SOUTH AFRICA
- SOUTH KOREA
- SPAIN
- SRI LANKA
- SURINAME
- SWEDEN
- SWITZERLAND
- SYRIA
- TAIWAN
- TAJKISTAN
- TANZANIA
- THAILAND
- TUNISIA
- TURKEY
- UKRAINE
- UNITED ARAB EMIRATES
- UNITED KINGDOM
- UNITED STATES
- URUGUAY
- VENEZUELA
- VIETNAM
- YEMEN

offices

Asia
Delta Light Asia Ltd.
 Mobile: +852 5501 7809
 E-mail: asia@deltalight.com
 www.deltalight.com

Denmark
Delta Light Denmark Aps
 Phone: +45 3311 4429
 E-mail: info@deltalight.dk
 www.deltalight.dk

Latin America
Delta Light Latin America
 Phone: +57 1 749 5307
 Mobile: +57 321 202 5501
 Mobile: +57 314 449 4015
 E-mail: info@deltalight-latin.com
 www.deltalight-latin.com

Russia, Eastern Europe, Middle Asia
Delta Light REEMA
 reema@deltalight.com
 Moscow:
 Phone: +7 926 03 888 93
 Saint-Petersburg:
 Phone: +7 921 79 183 88
 www.deltalight.ru

The Netherlands
Delta Light Nederland B.V.
 Phone: +31 (0)88 80 40 600
 Fax: +31 (0)88 80 40 699
 E-mail: info@deltalight.nl
 www.deltalight.nl

Belgium / Luxembourg
Delta Light® nv
 Phone: +32 (0)56 435 735
 Fax: +32 (0)56 435 736
 E-mail: info@deltalight.be
 www.deltalight.be

France
Delta Light France SA
 Phone: +33 (0)4 72 90 45 45
 Fax: +33 (0)4 72 90 45 44
 E-mail: dlinfo@deltalight.fr
 www.deltalight.fr

Middle East & North Africa
Delta Light Mena
 Phone: +961 1 491 175
 Fax: +961 1 491 173
 E-mail: sales@deltalight-mena.com
 www.deltalight-mena.com

Spain
Iluminación Delta Light España S.A.
 Phone: +34 (0)93 586 19 00
 Fax: +34 (0)93 697 95 00
 E-mail: marketing@deltalight.es
 www.deltalight.es

United Kingdom
Delta Light UK LTD
 Phone: +44 (0)870 757 7087
 Fax: +44 (0)207 620 0985
 E-mail: info@deltalight.co.uk
 www.deltalight.co.uk

Canada
Delta Light Canada Inc.
 Phone: +1 905 813 6130
 Fax: +1 905 813 7073
 E-mail: canada@deltalight.com
 www.deltalight.ca

Germany / Austria
DELTA LINE + LIGHT GmbH
 Phone: +49 (0)2451 4090-0
 Fax: +49 (0)2451 4090-200
 E-mail: info@deltalight.de
 www.deltalight.de

Poland
Delta Light Poland
 Phone: +48 698 33 00 03
 E-mail: poland@deltalight.com
 www.deltalight.pl

Switzerland
Delta Light AG
 Phone: +41 (0)61 485 99 10
 Fax: +41 (0)61 485 99 11
 E-mail: info@deltalight.ch
 www.deltalight.ch

USA
Delta Light USA, LLC.
 Phone: +1 (954) 677 9800
 Fax: +1 (954) 677 1007
 E-mail: info@deltalight.us
 www.deltalight.us

Czech Republic
Delta Light Czech s.r.o.
 Phone: +420 241 740 775
 +420 241 740 776
 Fax: +420 241 740 687
 E-mail: info@deltalight.cz
 www.deltalight.cz

Italy
Delta Light Italia S.r.l.
 Phone: +39 0 571 82226
 +39 0 571 93541
 Fax: +39 0 571 83594
 E-mail: info@deltalight.it
 www.deltalight.it

Slovakia
Delta Light Slovakia s.r.o.
 Phone: +421 2 6353 0180
 Fax: +421 2 6353 0181
 E-mail: info@deltalight.sk
 www.deltalight.sk



New
Collection
2014-2015

 **DELTA LIGHT**[®]
deltalight.com