

Decra Elegance Tile

Installation Instructions (March 2015)

Decra®
Roof Systems



Our Contact Details

If there is anything in this guide that you do not understand or that is unclear to you please do not hesitate to contact us on;

Tel: 0161 8654444

Fax: 0161 8642616

Web: www.decra.co.uk

Email: technical@decra.co.uk

1. Safety

These instructions are illustrative only. For the sake of clarity, access equipment, which should always be erected in accordance with safety regulations, has been omitted, as have safety helmets, roofing felt and sarking boards.

In common with traditional roof slates and other smooth surfaced roofing products, care should be taken when walking on Decra Elegance tiles particularly in wet, frosty or icy conditions.

In these conditions properly designed roof ladders or crawling boards are an advisable safety aid.

2. You Need

Pencil.

Chino graph pen (i.e. wax crayon)

Tape measure or ruler.

Tin snips.

Decra hand nails, Decra Power Nails* or Decra Screws.

***i* You must only use fixing nails and screws supplied by Decra, OTHERWISE the Decra guarantee is invalidated.**

Decra roofing felt or breather membranes.

Soft soled safety shoes.

Safety helmet.

**Decra Power nails are designed for use with a Paslode IM350 frame nailer gun.*

3. You Also Need

To cut the tiles and accessories you need;

Decra Tile Guillotine or alternatively a reciprocating saw or jigsaw (fitted with an appropriate Decra Cutting Blade).

***i* DO NOT USE angle grinders or disk cutting equipment.**

To form edge details to the perimeters of the roof you need.

Decra Tile Bender.

Decra Tile Bender Attachment (for bending the full length of a tile).

IMPORTANT - Operatives are reminded to take all due care when handling sharp edges and using tools.

4. Setting Out The Fascia Board At Eaves

The positioning of the fascia board at the eaves is crucial to the success of the installation.

The fascia board must be set at the right height, set too low the tiles will dive, set too high the tiles will kick up at the wrong angle. The top edge of the fascia board should be set at the same height as the tile battens.

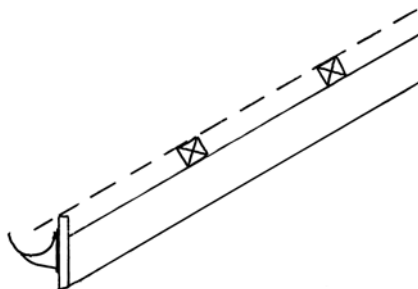

However if you are installing fascia mounted eave ventilators or Decra Eaves Guard the fascia board may need to be set lower (refer to the instructions supplied in the Decra Ventilation pack & Decra Eaves Guard pack).

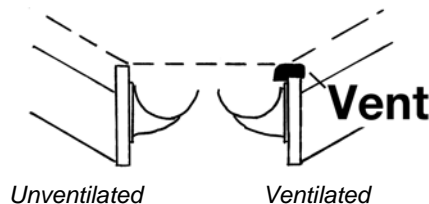

5. Battening

The most crucial factor in laying tiles is the accurate setting out of the tile battens, if you are not accurate then the tiles won't fit together properly.

Time spent taking extra care when battening is time saved when tiling.

Batten Sizes

Rafter Centres	Batten Size (recommended)
450mm	38mm x 25mm
600mm	50mm x 25mm
900mm	50mm x 50mm
1200mm	50mm x 50mm

6. Setting Out The Battens At Eaves

The positioning of the first batten at the eaves is crucial to the success of the installation.

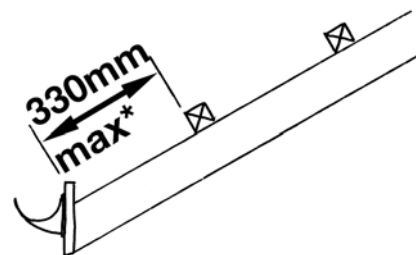

* The first tile batten should be placed in a position to suit the roof pitch and/or type of gutter, typically this is 330mm from the front edge of the fascia board to the front edge of the first tile batten.

However if you are installing fascia mounted eave ventilators refer to the instruction supplied in the Decra Ventilation pack.

7. Battening The Roof

Then fix the other battens working from the bottom of the rafter, at 370mm spacings from front lower face of batten to front lower face of batten.

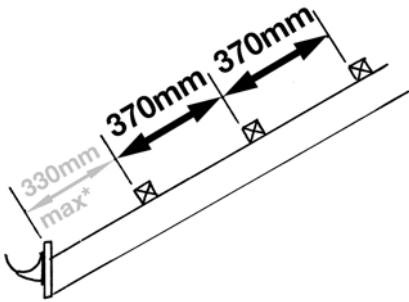

Care should be taken to be accurate when installing the battens. Time spent taking extra care when battening is time saved when tiling.

8. Decra Eaves Guards

Decra Eaves Guard is an eave protection system which is installed underneath the roofing underlay providing support for the underlay at eaves.

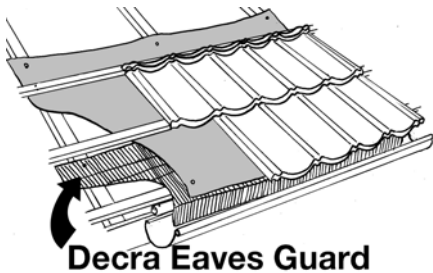

The installation procedure for the Decra Eaves Guard varies according to roof pitch and rafter spacing.

If you are installing the Decra Eaves Guard refer to the instruction supplied in Decra Eaves Guard pack.

9. Setting Out Gables

Fix the bargeboard level with the bottom edge of the tile battens.

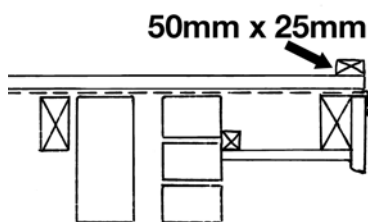

Underlay should over sail the edge of bargeboard by 25mm. Turn edge of underlay down the outer face of the barge board and tack into place.

The cut ends of the tile battens must be in line with the outer edge of the bargeboard.

Install 50mm x 25mm treated gable runner batten on top of the tile battens (outer edge of gable runner batten to be in line with outer face of bargeboard).

10. Walking On The Tiles

In common with traditional roof slates and other smooth surfaced roofing products, care should be taken when walking on Decra Elegance tiles particularly in wet, frosty or icy conditions.

In these conditions properly designed roof ladders or crawling boards are an advisable safety aid.

When walking on the roof it is strongly recommended that installers should wear soft soled safety shoes to avoid any possible abrasion to the surface coating.

Your weight should be concentrated over the front edge and in the pan of tiles, as this is the area supported by battens. Weight **MUST NOT** be applied to the raised crown of the profile on the middle of tiles.

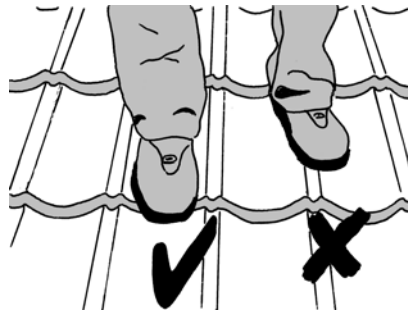

If you have managed to dent a tile refer to the tips section at the back of this guide.

11. Start Laying The tiles

Lay the tiles starting at the batten below the ridge.

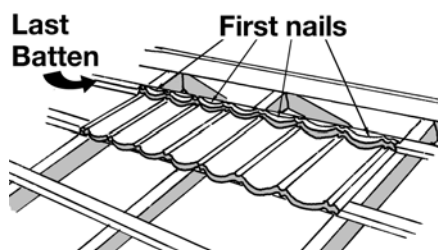

When putting your first nails in take care not to puncture the underlay below.

Q Why lay from the top?

A Although this is the opposite of traditional tiling practice, by laying from the top the tiles interlock tighter and it is actually quicker to lay the Decra tiles this way.

Q Do I lay the tiles straight bond or staggered bond?

A The choice is yours, If you are roofing a straight forward gable to gable roof then straight bond is the quickest way to do it, but for best appearance lay the laps away from the principle line of site of the building.

If you are roofing a hipped or valley roof then you will find that it's quicker to lay the tiles broken bond, working away from the hip and valley.

Q Starting from a gable end?

A Then don't forget you may need to allow for an appropriate upstand at the gable end of the tile (see gable sections).

Q How much side lap?

A

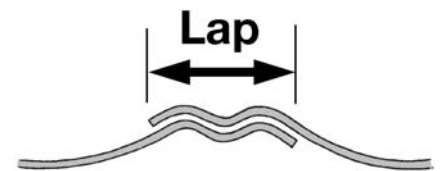

Q Which direction should I lap the tiles?

A Decra Elegance Tiles can be laid from left to right or right to left but for best appearance lay laps away from the principle line of sight.

12. When You Have Laid Several Courses

When you have laid several courses (laying one under the other, by lifting the nose of a tile and tucking the next tile under) start nailing with Decra nails, 4 per tile at laps and every other pan.

Nail tiles through the nose as shown in the sketches, leaving bottom course loose until more tiles are laid.

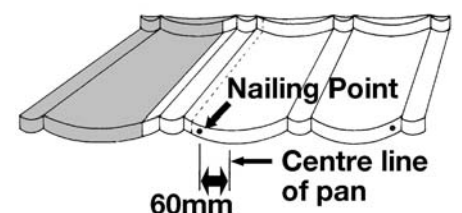
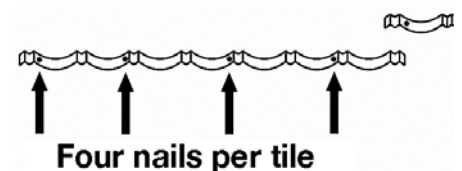

Tilt nail downwards for the best fit

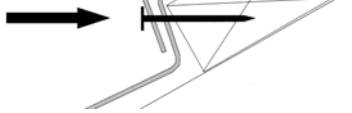

i You must only use fixing nails and screws supplied by Decra, OTHERWISE the Decra guarantee is invalidated.

13. Nail The Eaves Course

Nail the eaves course 10mm from the high point of the pan into the top of fascia or eaves batten (if eaves ventilation is being fitted, see ventilation pack for nail positions).

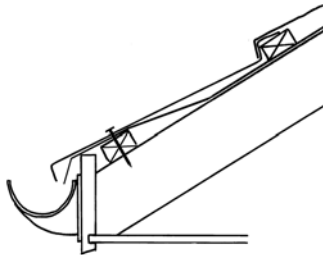
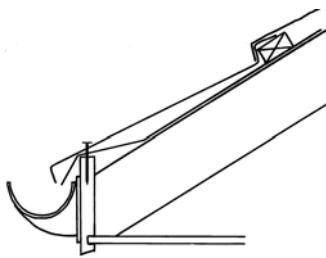
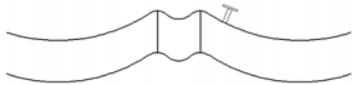

Use 4 nails per each tile.

After completion of roof cover these nail heads with Decra finishing kit.

15. Gables

Using the Decra Cloaked Verge Cap

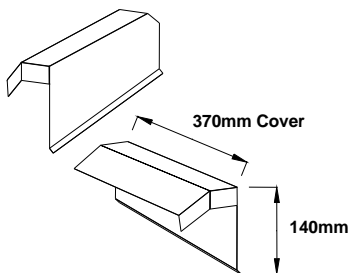

Step 1

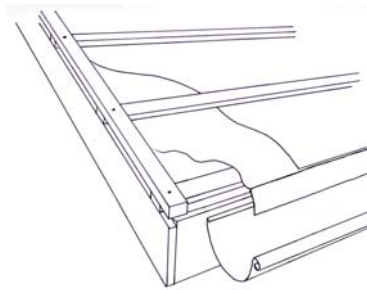

Bargeboard to be set level with bottom edge of tile battens.

Underlay should overlap the edge of bargeboard by 25mm. Turn edge of underlay down the outer face of the barge board and tack into place.

The cut ends of the tile battens must be in line with the outer edge of the bargeboard.

Install 50mm x 25mm treated gable runner batten on top of the tile battens (outer edge of gable runner batten to be in line with outer face of bargeboard).

Step 2

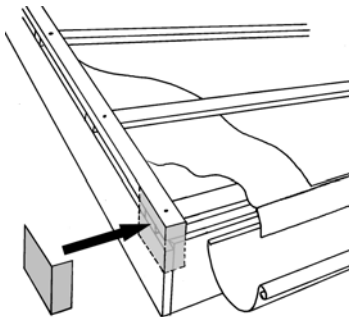

Cover bottom edge of bargeboard with cloaking piece of Decra (this can be cut from a piece of Decra top course or ridge cap).

Step 3

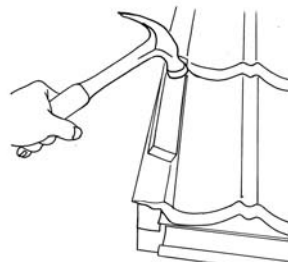
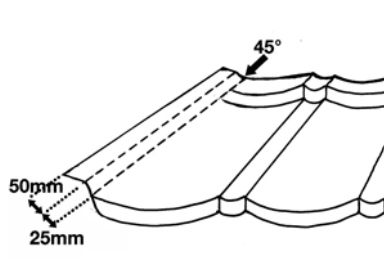

Decra tiles to be cut and bent, using a guillotine and bender (available from Decra), to form a 75mm flange, first 25mm flange to upstand against gable runner batten, remaining 50mm of flange to be dressed down flat forming a cover over the top face of gable runner batten.

tip; a short piece of batten makes a good dressing down tool.

For tips on cutting and bending tiles, see back of this guide

Step 4

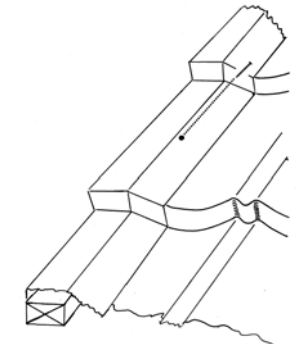
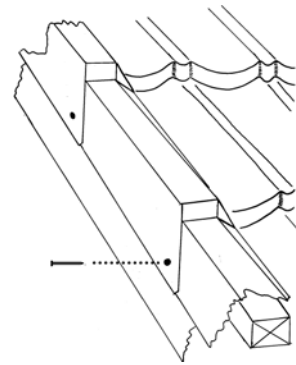

Starting at the eaves and working up the slope install Decra Cloaked Verge cap on top of tile flange (i.e. over the gable runner battens) and secure with two Decra fixing nails.

The first nail driven horizontally through the downturned edge of the Decra Cloaked Verge cap into the barge board.

The second nail skew fixed half way down the top inner face of the Decra Cloaked Verge cap through the top edge of the 25mm upstand flange into the underlying gable runner batten.

The heads of vertical nails should be sealed using a Decra finishing kit.

16. Ridge Course D Ridge

The correct way to install the top course of tiles and the ridge tiles is dictated by whether you are trying to achieve an unventilated or ventilated ridge detail.

NOTE: Be aware there is more than one type of ridge ventilation system.



D ridge vent filler



Universal ridge ventilator

17. Preparation Of The Top Course Of Tiles

When you have cut and bent the tile you may find there is some natural distortion in the tile and it may look like the tile won't fit. This is perfectly normal

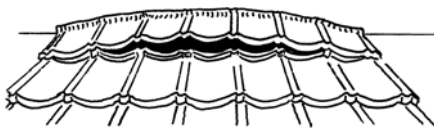

There is a standard procedure for removing any distortion. If this procedure is followed, installation is simple. If not followed it will be difficult to achieve a good fit.

Step 1: Do not try to squash the tile into position at this stage (wait until you have completed step 4).

Locate front corner of tile into the interlocking profile of tile below and nail this corner into position.

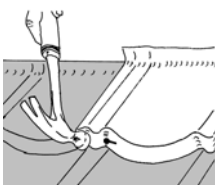

Step 2: Locate rear corner of tile into interlock of adjoining tile and nail this corner into position as appropriate.

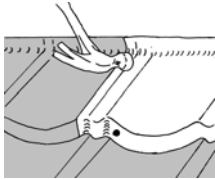

Step 3: Locate other front corner of tile into interlock of tile below and nail this corner into position.

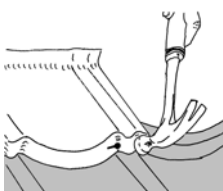

Step 4: locate remaining rear corner of tile into position and nail as appropriate.

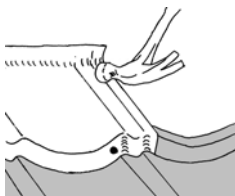

Step 5: Push front edge of tile into position and work your way into the middle nailing as you go.

18. Ridge Course Nailing & Lapping D Ridges

The ridge caps have a slight taper in their design. Place the wider end of the ridge over the narrower end of the ridge beneath creating an 80mm overlap.

Each ridge should be secured with 4 nails on each side of the ridge cap.

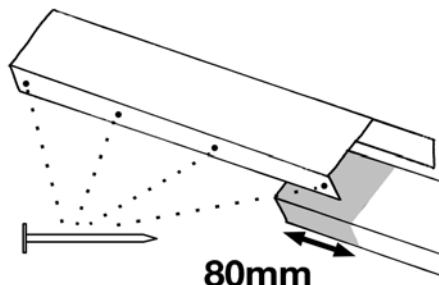

19. Ridge Course D Ridge (Unventilated)

Fit two tile battens either side of ridge. Fix additional 50mm x 25mm batten to suit D Ridge on top of rear of the two tile battens.

Lay top course of tiles with back turned up 38mm.

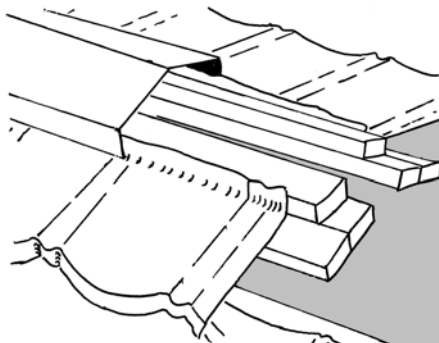

i For tips on cutting and bending tiles, see back of this guide

20. Ridge Course D Ridge With D Ridge Vent Filler

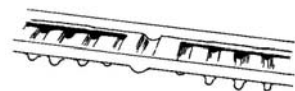

D ridge vent filler

Cut underlay short of ridge line and fit two tile battens either side of ridge, leaving a sufficient gap for ventilation.

Lay top course of tiles with back turned up 38mm. Using a D Ridge as a guide, fit 50mm x 25mm battens and ridge vent filler units either side of ridge and fix

through high point of tiles at laps and two in between the laps (see fixing instructions with ventilation pack).

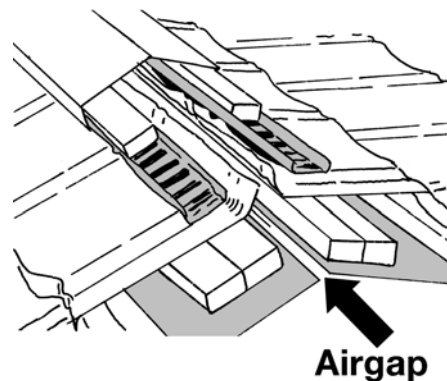

i For tips on cutting and bending tiles, see back of this guide

21. Ridge Course D Ridge With Universal D Ridge Vent



Universal ridge ventilator

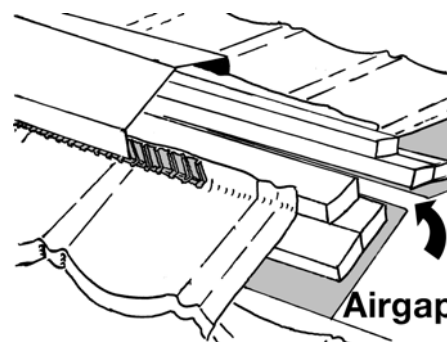

Cut underlay short of ridge line and fit two tile battens either side of ridge, leaving a sufficient gap for ventilation.

Fix additional tile batten to suit ridge on top of rear of the two tile battens.

Lay top course of tiles with back turned up 38mm against top tile batten.

Place ridge cap into position over the top batten and the upstand edge of tile. Pull bottom edge of ridge cap away from the upstand edge of tiles and slip Universal 'D' ridge/hip ventilators into position on each side of the 'D' ridge cap. Ventilators should run continuously along each side of the ridge cap.

The ridge cap and ventilator to be nailed through the downturn of the ridge cap into the face of the batten, using four Decra fixing nails on each side.

i For tips on cutting and bending tiles, see back of this guide

22. D Ridge Ends Caps

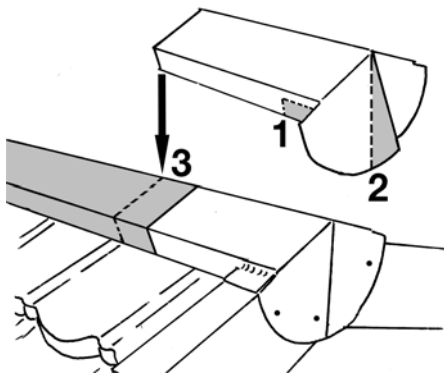

1. Snip and fold out flap to suit choice of verge/barge cover.
2. Trim edge of flap to create a vertical plumbline when fitted.
3. Install D Ridges over end of D Ridge End Cap ensuring good tight lap occurs. Then nail D Ridge End Cap into position (Fix vertical end of D Ridge End Cap first).

23. Mono-Pitch D Ridge

Mono-pitch ridge caps can be formed by adjusting the angles of Decra's standard D Ridge cap.

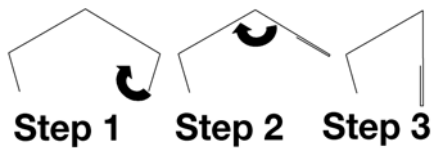

The procedure for installing the monopitch ridge is essentially the same as the detail for the ridges (please refer to ridge instruction shown earlier in this guide).

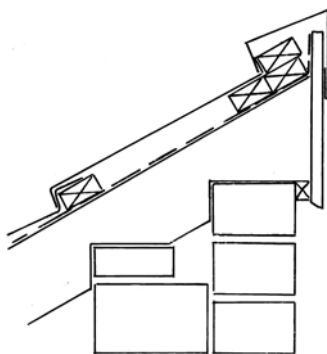

Unvented

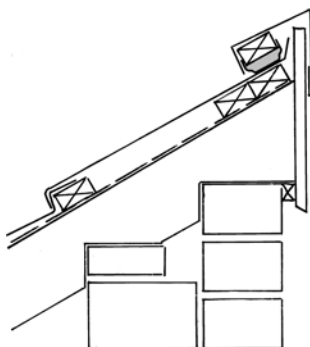

Vented with a D Ridge Vent Filler*

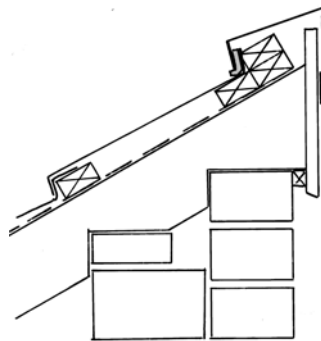

Vented using a Universal D Ridge Vent*

*When fitting the two tile battens at the top remember to leave a sufficient gap for ventilation

* When fitting the D ridge ensure that a gap of at least 5mm is maintained between the underside of the ridge and the topmost batten

i For tips on cutting and bending tiles, see back of this guide

24. Top Edge Abutment

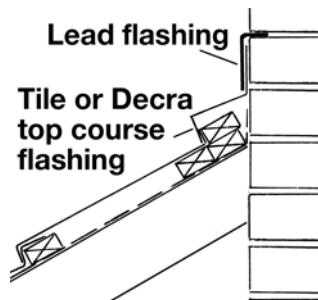

Unvented

Turn the tile (or a Decra Top course flashing) and the roofing underlay 75mm up the abutment wall and cover over with a lead flashing

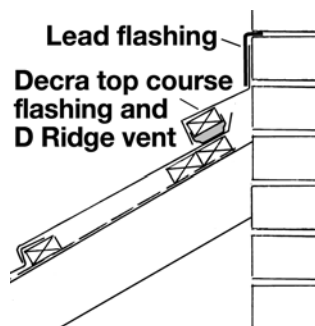

Vented with a D Ridge Vent Filler

(When fitting the two tile battens at the top remember to leave a sufficient gap for ventilation)

i For tips on cutting and bending tiles, see back of this guide

25. Side Edge Abutment

Turn the tile and roofing underlay 75mm up the abutment wall and cover over with a lead flashing.

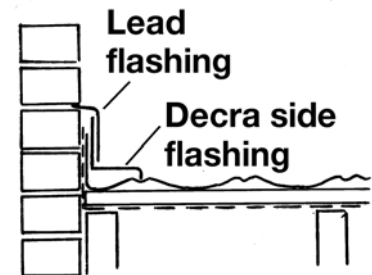
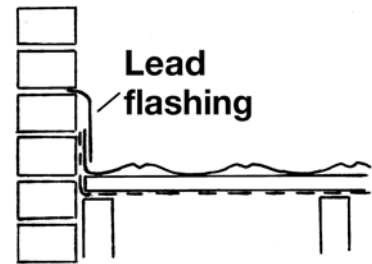

i For tips on cutting and bending tiles, see back of this guide

26. Hips

Install tile battens to suit gauge of tiles, ensure that tile battens project to centre line of hip tree.

Install hip runner batten to each side of hip to suit width of hip cap component.

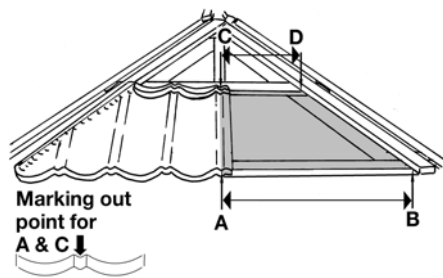

Step 1, Measuring for the Hip Tile

Measure from point (A) to (B). Measure from point (C) to (D), write down these measurements as this will be the set distance to make your bend at.

Step 2, Marking Out Your Hip Tile

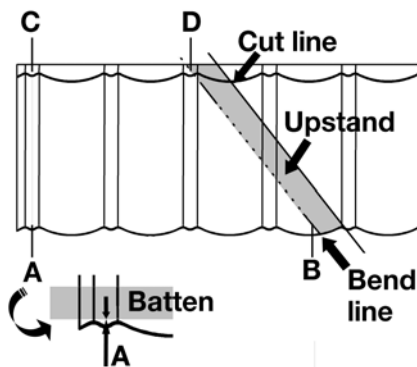

Mark out the same measurement (A) to (B) & (C) to (D) to a tile. When transferring measurements to tile ensure measurement corresponds with the position of the underlying tile batten (see batten intersection drawing below).

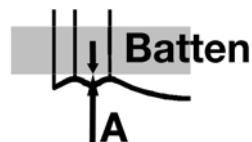

Using a pencil or Chino graph pen (i.e. wax crayon) mark a line from (B) to (D), this will be the bending point for your hip tile.

Using a pencil or Chino graph pen (i.e. wax crayon) mark an additional cut line on to the tile to allow for a tile upstand at the hip. This upstand should be sufficient to cover the hip runner batten (any excess in the upturn can be dressed over the top of the hip batten).

Step 3, Cut and bend your hip tile

See tips on cutting and bending tiles at back of this guide

Step 4, Install ridge cap to hip

The methods for installing Decra D ridges with or without Universal D ridge ventilators is the same in principle as

shown for the ridge detailing earlier in this guide.

NOTE: Pre-finished hip end closures are available for the foot of the hip.

27. Forming A Three Way Intersection At Hips

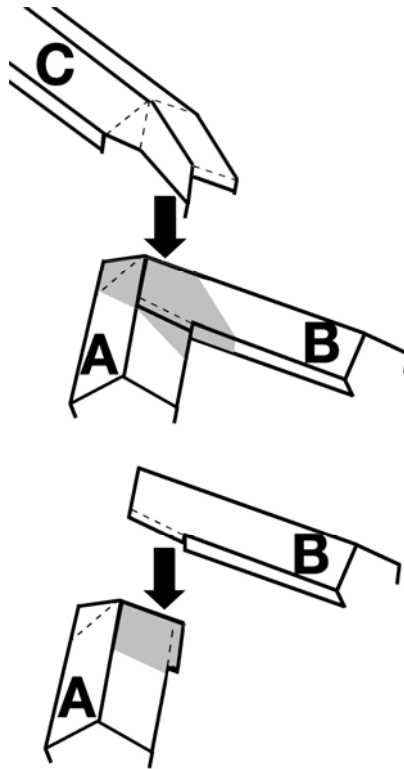

To form a three way intersection using D Ridges cut and fold tabs and flaps in ridge tiles as shown ridge sections A, B & C above. Install ridge section A followed by ridge section B then C on top. Nail ridge caps into position and touch up with Decra finishing kit.

28. Valleys

Lay valley boards flush with rafter level and install valley runner batten to each side of valley.

If needed install an additional packer batten, parallel to side of valley runner batten, so as to support sweep of tile batten.

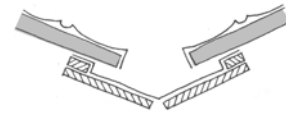

Install tile battens to suit gauge of tiles, ensure that tile battens sweep up and over valley runner batten. Cut battens to rake projecting over valley to 65mm short of centre line of valley.

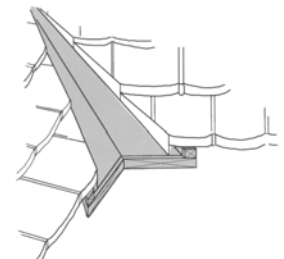

For measuring, marking out, cutting and bending valley tiles follow the same procedure as the hips (refer to hip section). But form a downturn in the valley tile rather than an upstand.

NOTE: When forming a downturn in the tile take a measurement from top of leading edge of tile batten to valley surface and allow for tolerance in fit to avoid the downturned edge of the tile making any contact with valley surface.



For tips on cutting and bending tiles, see back of this guide

Decra Tool Assembly Instructions

Classic, Parctile, Stratos, Oberon & Elegance (March 2015)

Decra®
Roof Systems



Decra Guillotine

Assembly

Depending on model, guillotine may be supplied dismantled. In this case insert 'A' frame legs in sockets in underside of guillotine body & secure by tightening wingnuts.

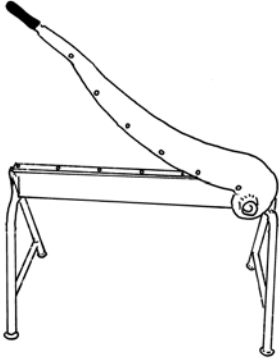

Decra Bender

Assembly

Put foot on treadle (C) and apply pressure, rotate treadle release catch (B) 90° clockwise to open position.

Foot treadle (C) should be in line with front legs of frame, when jaws (D) are closed. Alignment can be changed by adjusting nuts on bolts (E).

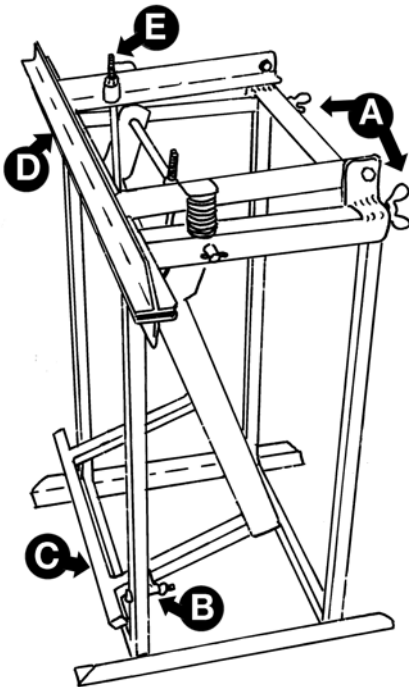

Bender Key

- (A) full-width bender attachment bolts
- (B) treadle release catch
- (C) treadle
- (D) bender jaws
- (E) jaw adjustment bolts

Decra Bender Attachment

Assembly

1. Locate holes in lower frame (A) onto bolts at rear of bender & secure with wing nuts.
2. Unlock bending beam (B) from travelling position by sliding to left and downwards.
3. Unscrew handle (D) from stowage position (C) & screw into socket on bending beam.

Operation

Position tile with edges under guide lips (F) & lock jaws shut with handle (E), before bending. A spacer (G) is provided for use with Stratos tiles.

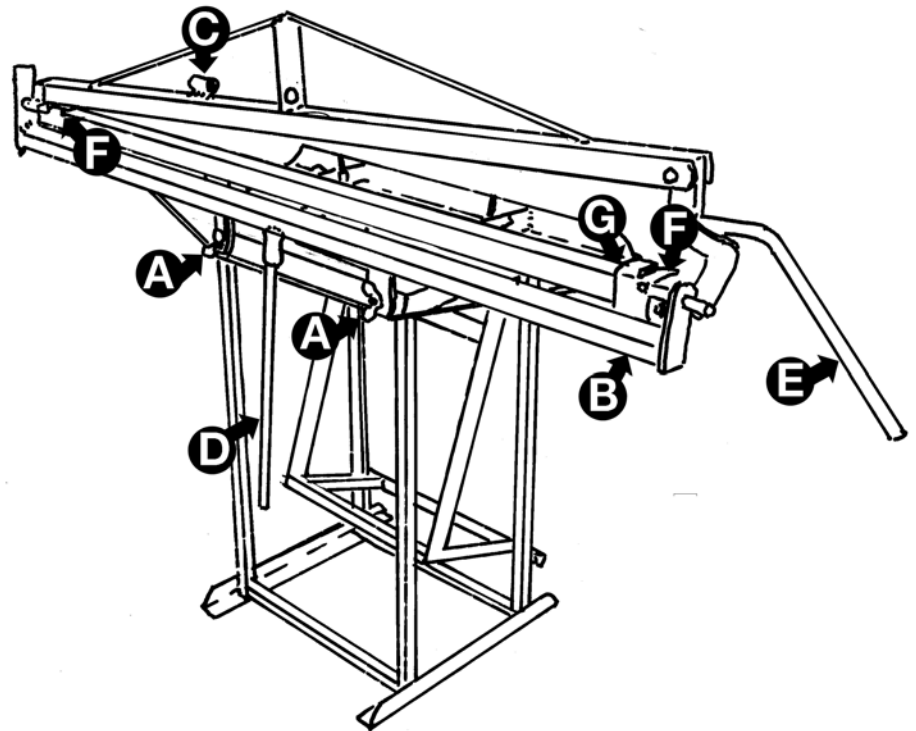

Bender Attachment Key

- (A) attachment holes
- (B) bending beam
- (C) bending beam handle stowage position
- (D) bending beam handle
- (E) jaw operating handle
- (F) tile edge guide lips
- (G) spacer for Stratos tile

Our Contact Details

If there is anything in this guide that you do not understand or that is unclear to you please do not hesitate to contact us on;

Tel: 0161 8654444
Fax: 0161 8642616
Web: www.decra.co.uk
Email: technical@decra.co.uk

Decra Roof System; Remember Safety

- Safety first.
- Never leave a guillotine unattended with the blade up.
- Always wear a safety helmet.
- Always wear soft-soled safety shoes.
- Always work from a safe platform or use a safety harness.
- Always ensure tools are set up correctly and are regularly maintained.
- Use tools safely.
- It is advisable to wear gloves to protect hands from any sharp edges.

Decra Installation Tips & Techniques

(March 2015)

Decra®
Roof Systems



Our Contact Details

If there is anything in this guide that you do not understand or that is unclear to you please do not hesitate to contact us on;

Tel: 0161 8654444

Fax: 0161 8642616

Web: www.decra.co.uk

Email: technical@decra.co.uk

(A) Using The Guillotine (applies to all Decra tile profiles except Decra Plus)

Operation

1. Stand facing guillotine & operate by pulling handle downward.
2. Always place tile face up (i.e. granulated side) in guillotine.
3. Cross-tile cuts should always be made with lowest point of tile pan to operator's left of guillotine blade. If necessary turn tile around to achieve this (see below).

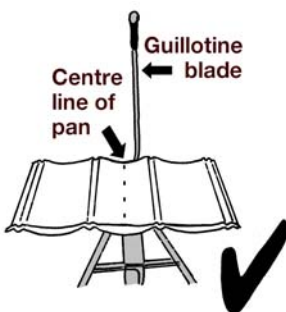
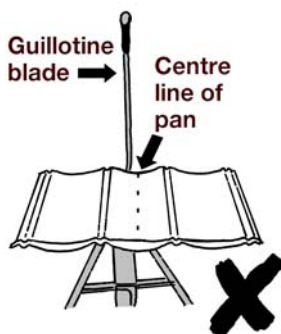

4. Nip edge of tile closest to blade hinge flat before commencing cut.
 5. Cross-tile cuts should be made before bending tile.
- Longitudinal (full width) cuts should be made after bending.

Do not use the guillotine for cutting small pieces where the hands could be too close to the blade.

Always ensure that the work piece is firmly held when cutting and bending Decra products. Only one person

should use the equipment so that risk of finger entrapment or injury is minimised.

(B) Cutting Tips

If the guillotine does not have a smooth cutting action

Decra's guillotine should have any easy, smooth cutting action when cutting a tile. If it feels like you are having to make too much effort while cutting, or if it feels like the guillotine blade is dragging, there is an easy solution to improving performance. Just wipe and clean the blade with an oily rag (3 in 1 oil or any other light oil will do as long as you do not leave too much oil residue on the blade).

If the guillotine has been left out in the rain on site you may find light corrosion marks on the blade. Clean these off with a wire brush or wire wool and once again wipe and clean the blade with an oily rag.

Dealing with tile scuff while using a reciprocating saw

If you find the sole plate of your reciprocating saw is making undesirable scuff marks on the top face of the tile. Flip the tile over and using a black marker pen mark your cut line on the back of the tile and the cut from the back.

(C) Forming A Top Course Of Tiles

(Applies to all Decra tile profiles except Decra Plus)

Insert and locate the tile

1. Position tile into the bender attachment.

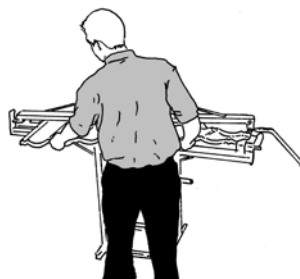

2. Tile should be offered into locating tabs of bender attachment.

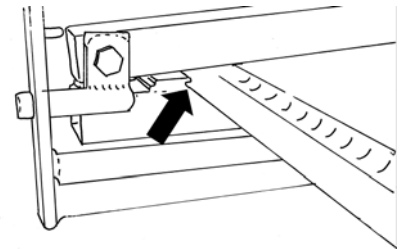

3. Ensure you locate other end of tile to adjustable tab. Tile located in position within the adjustable tab (see black arrow). Lift lever arm up to lock jaws of bender attachment (see grey arrow).

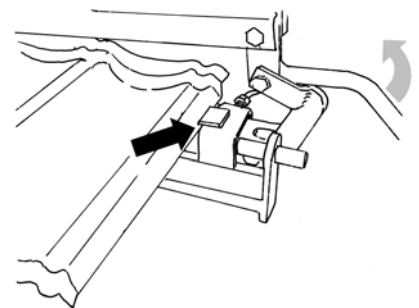

Bending technique

4. Set the Bender by tilting the bender away from operators body, whilst supporting with left arm (for right handed people). With other hand take hold of handle ready to control bending process.

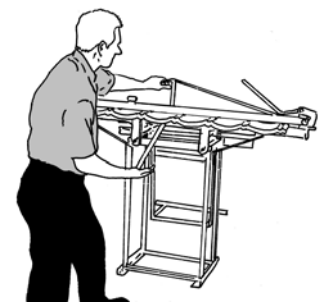

5. Lock lever arm to operator's side and allow bender to rotate gently towards operator.

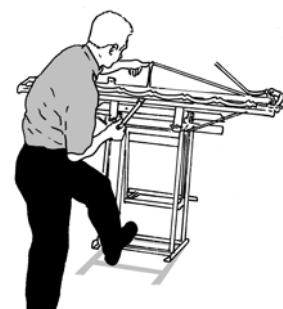

6. As the bender comes to ground level extend sweep of arm controlling the lever.

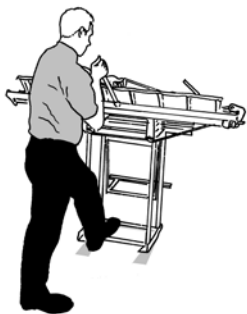

Raise lever to extent of sweep action to create full upturn bend. Operators arm is extending to control unit and bend of tile. Lever in full sweep position of bent tile.

Unlock the tile

7. Carefully grip tile and pull tile out of locating tab. Slide tile to right and lift bent tile out and away from bender.

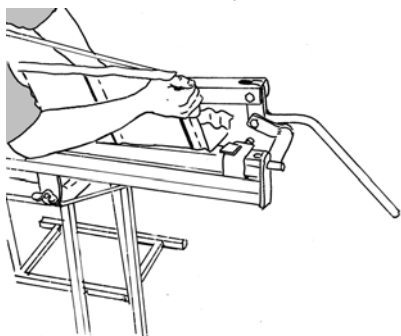

(D) Forming A Side Upstand

(applies to all Decra tile profiles)

Bending preparation

1. First, flatten downturn of tile at front corner. Some distortion will occur with flattening process, this is normal. Repeat process for rear corner of tile.

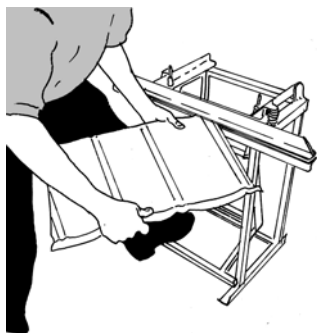

Bending

2. Offer tile into jaws of bender using fingers as stop guide for size of upturn.

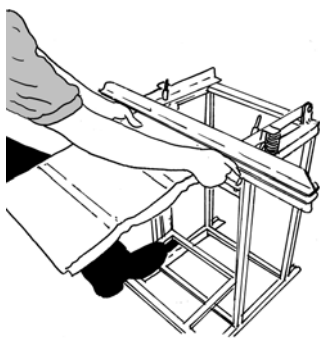

3. Keeping fingers clear of vice jaws apply controlled pressure foot to peddle bar. Jaws will then clamp tile.

4. With tile held by jaws of bender hold pressure on peddle and prepare to bend tile.

5. Keeping foot pressed fully on peddle, bend tile in upward direction a full 90°, thus forming upturn.

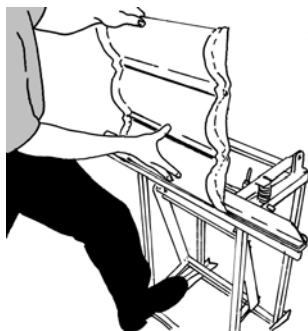

i If you are installing Decra Oberon Tiles please also read the section "Bending Tips For Oberon Tiles" later in this guide

(E) Forming A Raking Cut & An Upturned Edge At Hips

(applies to all Decra tile profiles except Decra Plus)

(Valleys carried out in similar procedure)

Marking out.

1. Once measurements taken for hip tile transfer measurements and mark onto tile with scribe using a batten as a guide (if using Decra Elegance DO NOT scribe, use a pencil, chino graph pen or wax crayon).

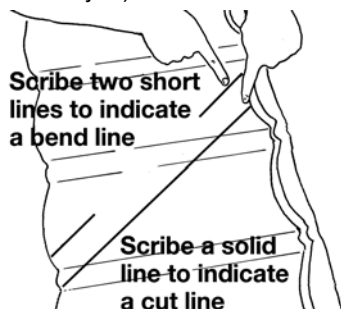

2. Allow for upturn distance to suit requirements. Remember continuous

line is cutting line two short lines are bending reference lines.

Cutting

3. Tilt tile to suit bed of guillotine as shown. (Don't put fingers close to cutting blade).



4. The portion of required tile is held by the left hand. Waste tile falls to the right of blade when viewed from operators position.

5. Apply controlled pressure to blade and with left hand control guide of tile against cutting blade.

Bending preparation

6. Offer tile to bender to flatten rear upturn and front downturn.

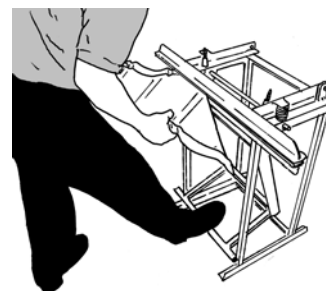

7. First, flatten front downturn of tile at front corner. By positioning front downturn into jaws of bender and applying pressure to peddle to flatten. Some distortion will occur with flattening process, this is normal.

8. Repeat the same flattening procedure for rear upturn.

Bending upturn

9. Then offer tile to scribed bending lines.

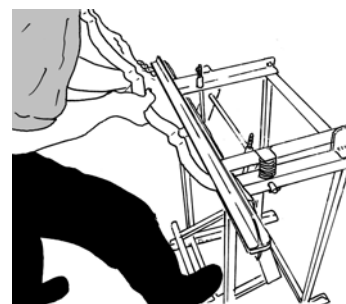

10. Apply pressure to bending jaws by foot peddle.

11. Start to bend tile in upward direction.

12. Bend tile upwards through full 90° to form upturn.

i If you are installing Decra Oberon Tiles please also read

the section “Bending Tips For Oberon Tiles” later in this guide

(F) Bending Tips (General)

How to bend very small bends in a small work piece

It is possible to make very small bends or form bends in a small piece of tile or tile accessory.

Tips how to do it

1. Tuck a bit of timber under your work piece and pinch it with your thumbs against the work piece (see image below). This will allow you to maintain sufficient grip and leverage when bending.
2. Don't try to bend the full length of your work piece in one go. By bending a smaller bend than needed and then moving the work piece along in the bender and bending again its possible to bend very small bends at quite awkward angles.

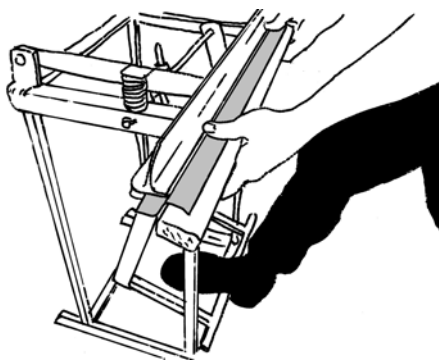

Dealing with tile scuff while bending

If you find the tile bender is making undesirable scuff marks on the top face of the tile, when bending the tiles at the valleys. Cut two thin strips of wood (50mm x 6mm or 2" x 1/4") and then tape them to the internal jaws of the bender. This will stop the tile slipping and causing scuffing when bending.

Tile slips whilst bending small work piece items for details

See “How to bend very small bends in a small work piece” and “Dealing with tile scuff while bending”

Having problems bending and forming small work piece details?

If you are new to Decra bending and forming small details (for example ridge hip intersection and mitres) can seem tricky to do.

Rather than having several attempts using Decra's steel components and wasting time and money, its often a good idea to use a piece of cardboard to have a go first. Cut lines, fold lines and tabs can easily be marked out and formed on cardboard and its much quicker to learn how to form your detail. Even better still this piece of cardboard

can then be used as a template to mark out on the Decra components.

(G) Bending Tips For Oberon Tiles

When forming an upstand or a downturn at the side of an Oberon Tile it is possible to cause unwanted distortion or damage in the centre step area of the tile (see image of tile in tile bender jaws below).



Folding the centre step incorrectly can cause problems

To avoid this occurring the correct bending procedure must be carried out.

Step 1

Flatten out step in the centre of the tile using the Decra Bender (Flatten only in the area of the tile which is to have an upstand or downturn formed).

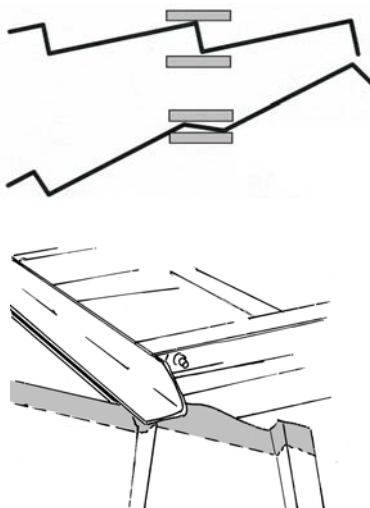

Step 2

Offer tile to bender to flatten rear upturn edge of tile and front downturned nose of tile.

First, flatten front downturn of tile at front corner. By positioning front downturn into jaws of bender and applying pressure to peddle to flatten. Repeat the same flattening procedure for rear upturn.

Step 3

Now place the full width of the area of the tile to be bent in the jaws of the bender and form your upstand or downturn in the tile as required.

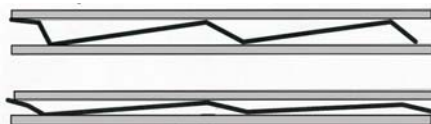

(H) Maintenance Procedures For Removal Of Tile Deformations Or Dents (Nail Fixed)

To remove light to medium dents without pronounced creasing in tile: Remove nails from front of deformed tile and to adjacent nails to tiles each side, allowing front edge of tile to be raised.

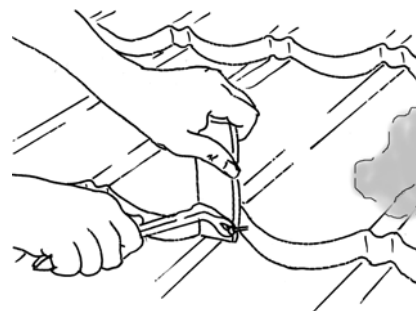

Tile nails are removed by using a carpenters nail puller or similar behind the nail head. When levering nails from front edge of tile, place a piece of batten between head of nail puller and tile surface, to enable maximum leverage to be applied and to prevent further damage or scuffing occurring.

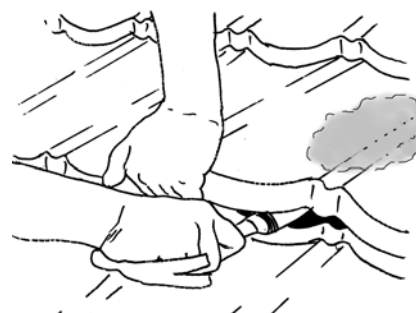

Lift unfastened front edge of deformed tile and slide shaft of a hammer under location of dent (shaft of hammer will form a lever against underlying tile batten). Push down on front edge of tile and hammer head until dent of tile pops back into correct position.

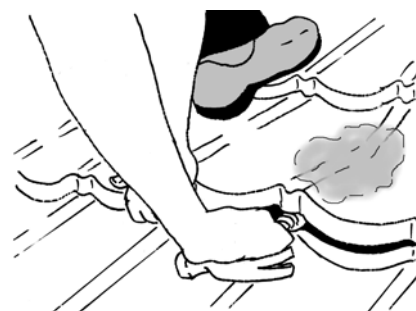

Install new Decra nails in the same positions as those removed earlier. In the event of nail holes in adjacent tiles being exposed, after fixing new tiles, these should have a Decra finishing kit applied to seal the holes, as should any scuff marks on tiles.

NOTE: Heavily dented or creased tiles may need complete replacement.

(I) Lost Drill Screw Bit

If you are screw fixing the tiles and have lost your drill screw bit a ¼" screw driver bit holder will fit the Decra screws

(J) Decra Roof System; Remember Safety

- Safety first.
- Never leave a guillotine unattended with the blade up.
- Always wear a safety helmet.
- Always wear soft-soled safety shoes.
- Always work from a safe platform or use a safety harness.
- Always ensure tools are set up correctly and are regularly maintained.
- Use tools safely.
- It is advisable to wear gloves to protect hands from any sharp edges.