

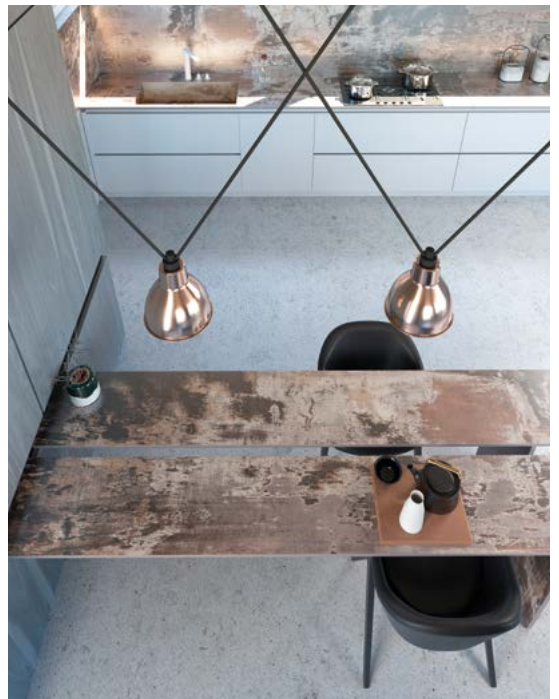

The Cosentino® Surfaces Experience



SILESTONE® DEKTON® SENSA



Contents

Cosentino Information	04
Cosentino's Environmental Commitment	06
Why Cosentino Surfaces	08
Product and Applications	
Silestone®	10
Silestone® Benefits	12
Silestone® Collection	14
Silestone® Applications	18
Dekton®	26
Dekton® Benefits	28
Dekton® Collection	30
Dekton® Applications	34
Sensa by Cosentino®	52
Sensa Benefits	54
Sensa Collection	57
Sensa Applications	58
Terms & Conditions	62

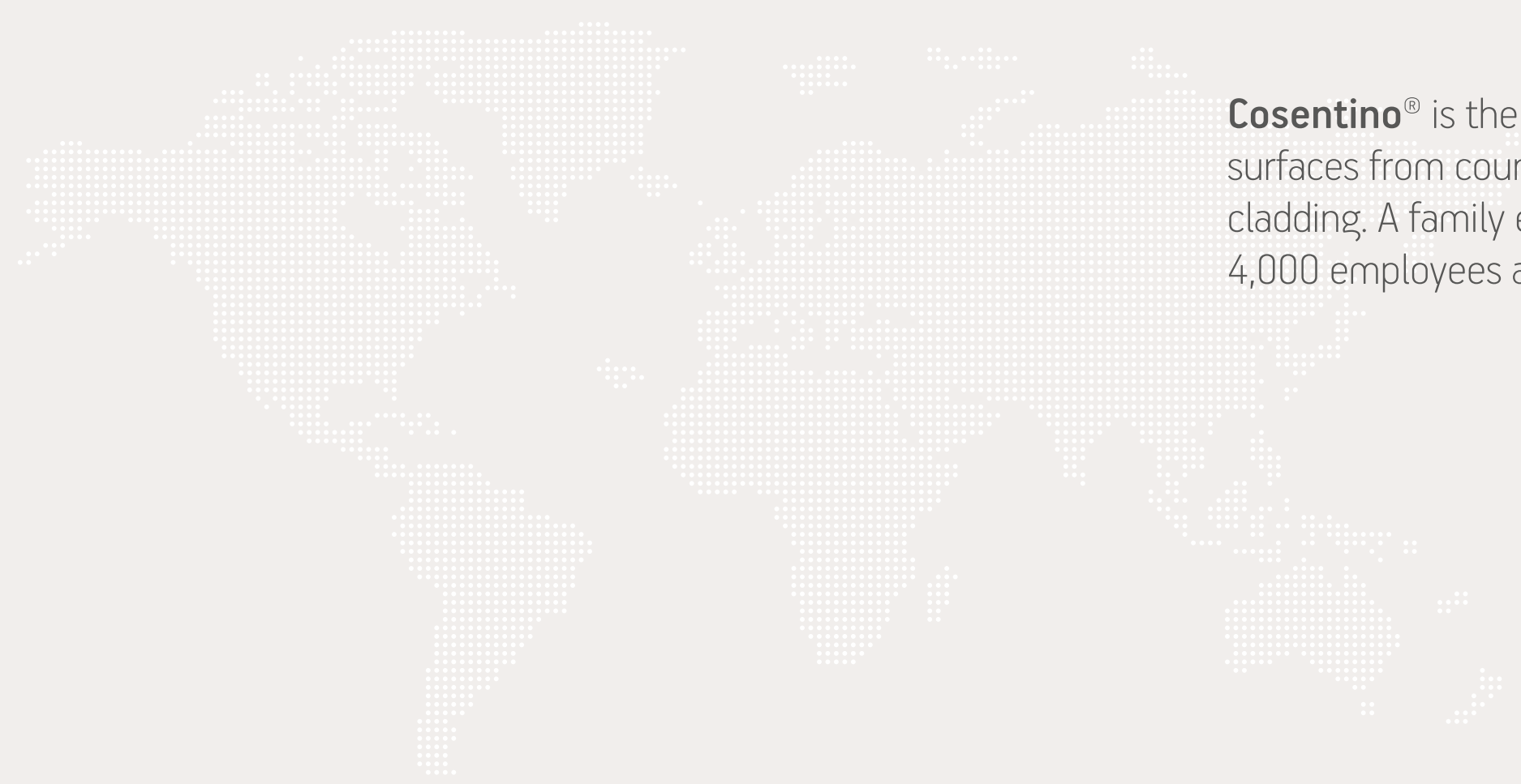

Cosentino® is the leading company in innovative surfaces from countertops to flooring and wall cladding. A family entrepreneurial group with over 4,000 employees around the world.

- 1 BELFAST
 - 2 DUBLIN
 - 3 SCOTLAND
 - 4 DARLINGTON
 - 5 MANCHESTER
 - 6 EAST LONDON
 - 7 NEWMARKET
 - 8 GLOUCESTER
 - 9 HOOK
 - 10 LONDON
- CENTER
 - NEW CENTER
 - CITY CENTER

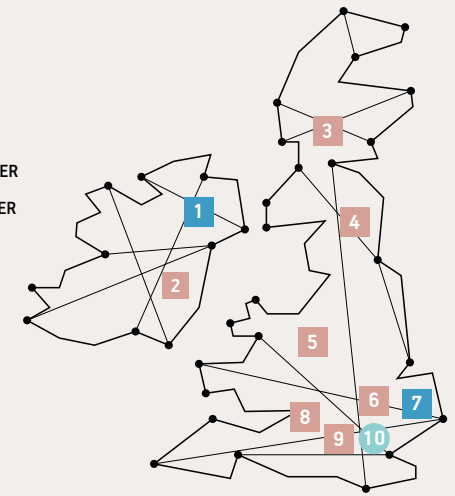

Our History

- 1980**
The company started as Mármoles Cosentino
- 1990**
Launch of Silestone® quartz
- 2004**
Launch of Sensa
- 2009**
Purchased 100% of the US subsidiary
- 2013**
Launch of Dekton®
- 2015**
Silestone® celebrates its 25th anniversary
- 2019**
Launch of Dekton 4mm

Our Today - stronger than ever

- Presence in 80 countries
- 11 Silestone® manufacturing lines (3 more to be fully operational by Q1 2020)
- 1 Natural stone factory in Brazil (2nd largest exporter of granite from Brazil)

Sustainability and the Circular Economy: Cosentino's Environmental Commitment

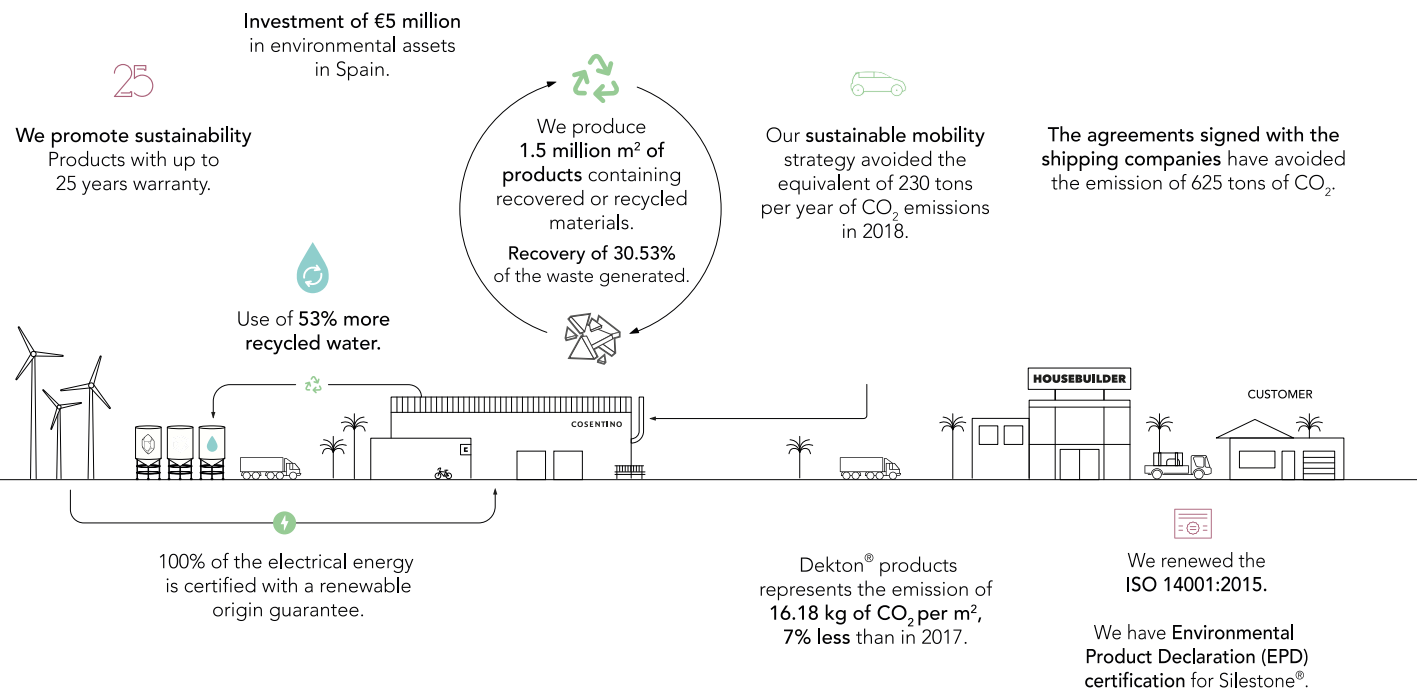

Sustainable future

These valuable projects will continue over the coming years, and mark some of Cosentino's most significant investments.

The company is in the advanced stages of planning for what will be one of Spain's largest renewable energy power plants for self-consumption. The project is currently going through the applicable administrative processes, and is expected to be implemented in 2020.

Cosentino will continue to empower the Circular Economy in its processes, and is filing proceedings for producing a license which would permit the utilisation of water from a county treatment plant. Construction of this new station for the Regeneration of Residual Water, located within Cosentino Park, is expected to commence this year.

Full Support and Service from the Leading Surface Provider

Special prices for agreed contract colours
Cosentino can discuss and agree special contract colours on approved colours which can be marketed as a bespoke core range.

Bespoke Marketing Tools
Cosentino UK can create bespoke sample displays and literature tailored for you. Can be personalised with your logo.



Free of charge display material for marketing suites and showhouses*

*Subject to approval

Visibility in the Media

Silestone and Dekton are widely recognised and respected brands, supported by a multi-million pound marketing plan. Our brands are deliberately positioned to be highly aspirational so that all our partners can benefit from consumer-motivated demand.



Why Cosentino® Surfaces

The entire Cosentino network is committed to helping you accomplish the key objective of producing satisfied Buyers. From quality materials and workmanship to home readiness and customer service, our focus is on providing solutions that add value to your Buyers and your homes.

All our products are bound and comply with strict regulations imposed by authorising bodies and our own exacting demands to provide sustainable, ethical, quality products and service.



Material Availability

Full control over the supply chain. Vertically integrated. From manufacturing to distribution to in some cases, countertop fabrication and installation.



Clear Pricing and Stability

Colours and price groups tailored to specific projects.



Quality and on-time Installation

Cosentino has the largest network of trained and certified Fabricators in the country. Products are always in stock and ready to meet production cycles.



Low Maintenance Products

Cosentino products are virtually maintenance free surfaces.



Marketing Support

Programme of free material for show houses is available. Ask for details.



Quality Point of Sale Materials

Small and larger samples are available through this programme along with literature designed to educate your Buyers on the features, benefits and overall value of owning Cosentino products. Sample boards can be made to your specific requirements.



Product and Process Training

Educating the Buyer on the value of Cosentino brands is also critical to your sales success. To help accomplish this, training is focused on the specific product and installation process. The goal of the training is to equip your staff with the ability to properly present, select, order and care for the chosen product.



Ensured Availability, Preferred Delivery

On-time completion and home-readiness are important to you and your Buyers. To maintain our installation commitments, our network of approved Fabricators are encouraged to keep a standard line of colours in stock for efficient turnaround.



Product Warranty

Silestone® and Dekton® offer a 25-Year Transferrable Warranty and Sensa a 15-Year Warranty.



Local Support to Regional Customers

Our large team of Sales Managers can visit all sites to offer full training.



Added Product Value for your Buyers

Reassures your Buyers with an unexpected level of product protection.

- Creates real differentiation for your homes around the kitchen and bathroom
- Provides your Buyers with a countertop choice that adds more value over regular stone



Enhanced Buyer Satisfaction

The entire Cosentino network is committed to helping you accomplish the key objective of producing satisfied Buyers. From quality materials and workmanship to home readiness and customer service, our focus is on providing solutions that add value to your Buyers and your homes.



Easy Warranty Registration

It's simple to register once for the whole project no matter how large and then hand over the warranty details along with the rest of the new-owner pack to your customer on completion.



Homeowner Care Program

Reliable service after move-in is essential to a builder who wants to enhance Buyer satisfaction. Dekton®, Silestone® and Sensa offer a Homeowner Care Program and product warranties. Our entire network of Certified Cosentino Installers are committed to servicing your Buyers and providing reliable service after the sale.



Grow Sales with the Leader

With the largest production and stock capacity in the quartz surfacing industry and the largest network of trained, certified quartz surfacing installers, building with Cosentino products means better home readiness for you and your Buyers.



Certified Assurance

All our products are bound and comply with strict regulations imposed by authorising bodies and our own exacting demands to provide sustainable, ethical, quality product and service.

PRODUCT AND APPLICATIONS



Welcome to our range of world-leading quartz

In 1992, a revolutionary quartz surface for the world of interiors and design was launched. Beautiful, functional and hygienic, worksurfaces are composed of over 90% natural quartz crystal. Silestone Quartz has nearly four times the flexural strength of granite and a high resistance to scratching, staining and heat damage.



The unique brand that gives you a certified warranty

Only the world's leading quartz surface manufacturer, could exceed itself once again by providing a 25 years warranty for all Silestone® quartz surfaces. Demand a genuine Silestone® worktop. Reject all imitations.

Easy to register for residential projects



Visit the website for more information
www.cosentino.com/en-gb/silestone



The Perfect Material

Silestone is a compound made up of 90% natural quartz, which make it extraordinarily hard and resilient. It is an excellent surface for kitchen worktops, bathrooms, floors and wall cladding using the minimum number of joints.



Bianco Calacatta

SILESTONE® Benefits



Stain Resistant

Silestone is a non-porous surface and highly resistant to stains from coffee, wine, lemon juice, olive oil, vinegar, makeup and many other everyday products.



Impact Resistant

We want your Silestone® surface to accompany you for many years to come. That is why we have worked hard to obtain a product with such high impact resistance, Silestone® is formed of a minimum of 90% quartz and materials of similar hardness.



Low Porosity

The advanced production system permits extreme compaction, which means it is a material with low porosity. Liquids stains and acids are not a problem for Silestone.®



Variety of Formats

No two kitchens are the same. We can cut pieces to measure and expose them to different processes and finishes.



Acid Resistant

Quartz is one of the hardest minerals in the world. This makes our products very durable, giving it a high resistance to acids.



High Scratch Resistance

Quartz is one of the hardest minerals in the world. This makes our products very durable, giving it a high resistance to scratches.



Wide Range of Colours and Textures

The range of colours available is ever developing. The smooth finishes as well as the elegant rough finishes, such as Suede and Volcano, are beautifully luxurious.



Custom Design

Cosentino® facilitates the manufacture of bespoke products for professionals, including shower trays, kitchen worktops, bathroom surfaces, washbasins or unique built-in sinks which are exclusive to Cosentino®.

SILESTONE® Collection

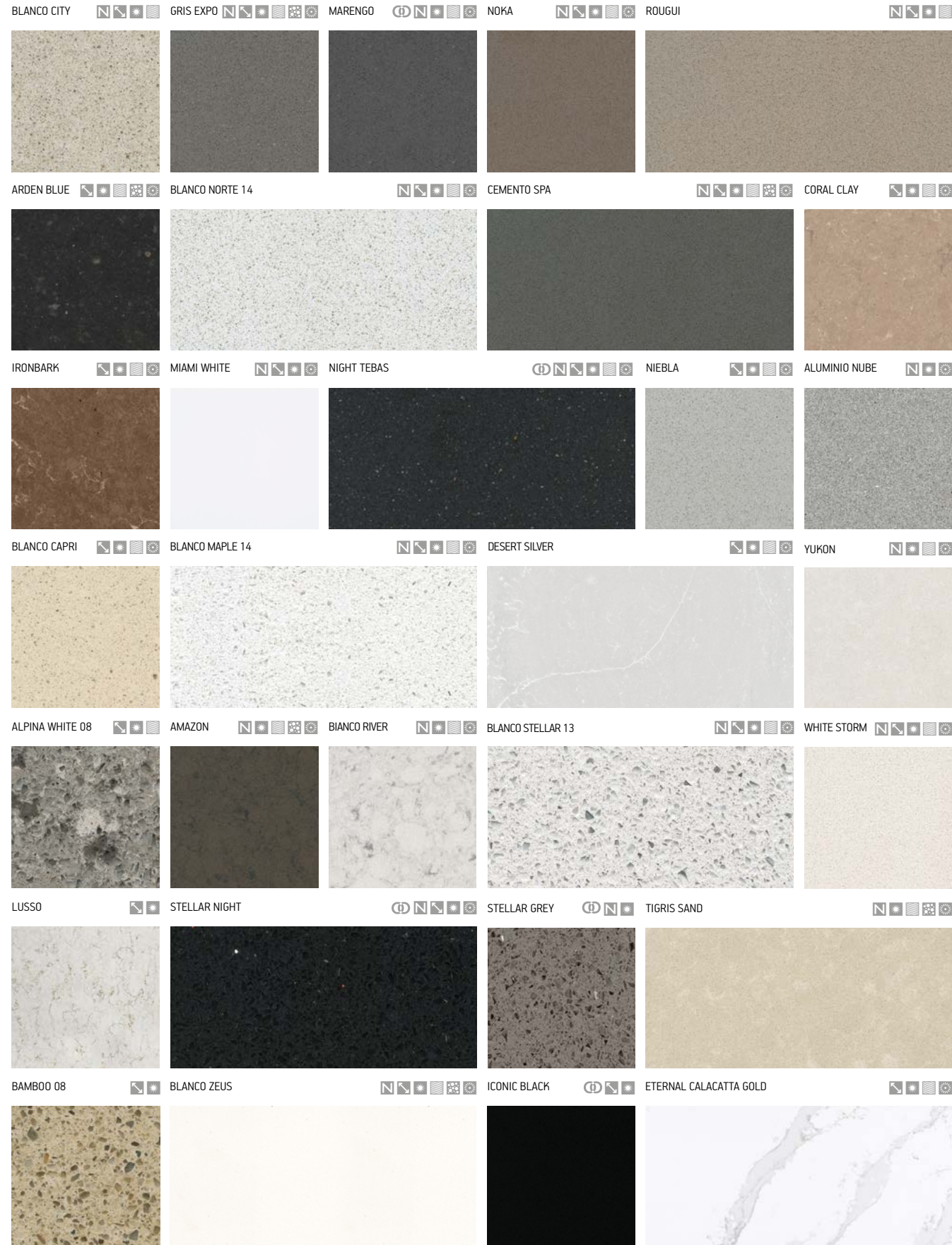

SILESTONE® Collection

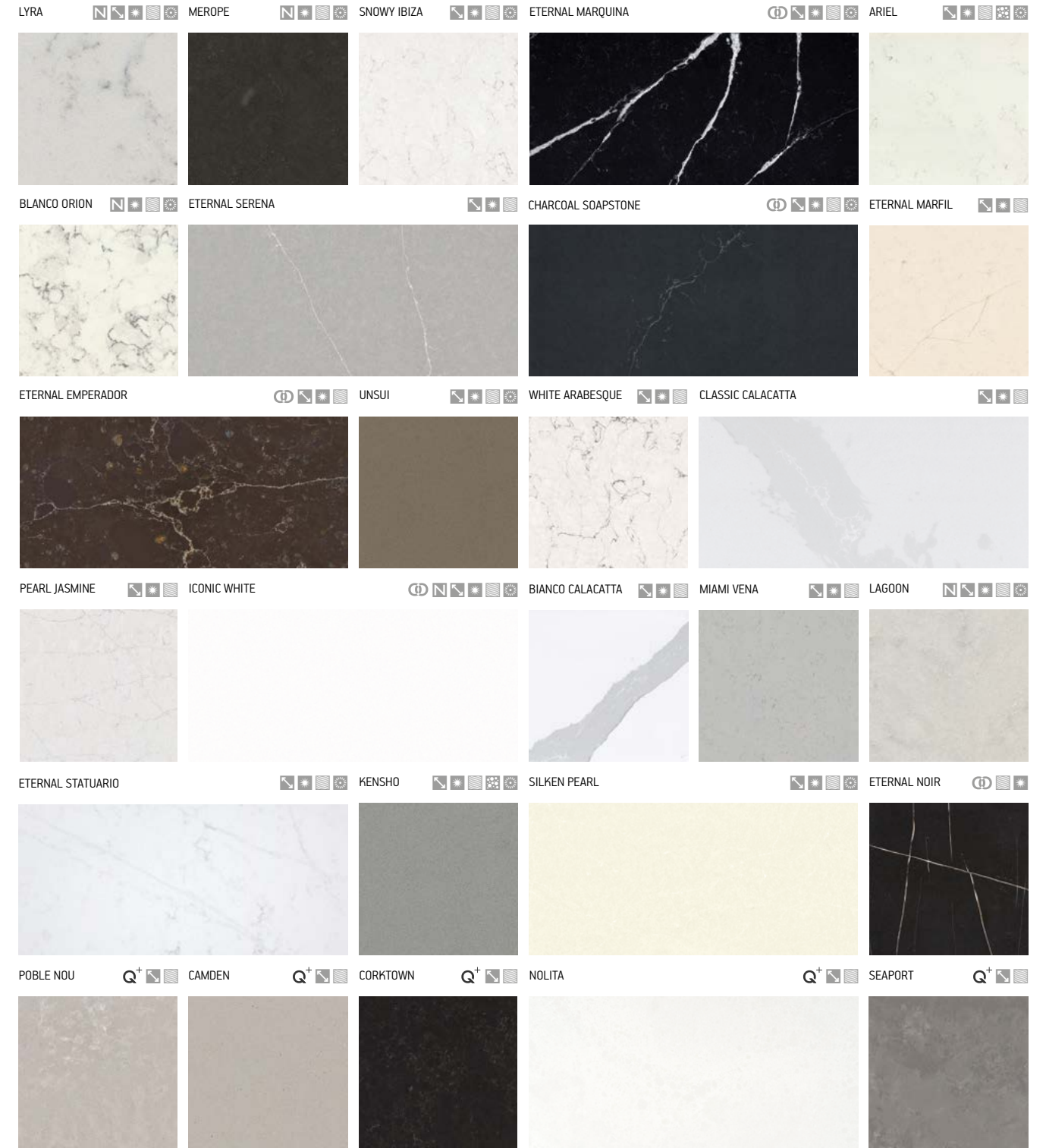

- ★ POLISHED texture
- SUEDE texture
- VOLCANO texture
- INTEGRITY sink
- Ⓢ N-BOOST property
- STANDARD (Up to 304cm x 141cm)
- JUMBO (up to 325cm x 141cm)
- Q+ Technology applied to Silestone which limits the use of crystalline silica to a maximum of 50% and minimum of 20%.

For SUEDE and VOLCANO finishing please ask for availability.

The provided samples don't guarantee that the supply will be absolutely identical in tone and veins.

See General Conditions of Sale.

SILESTONE®
Collection

GROUP 1	GROUP 2	GROUP 3	GROUP 4	GROUP 5	GROUP 6
BLANCO CITY	ARDEN BLUE	ALPINA WHITE 08	BAMBOO 08	CHARCOAL SOAPSTONE	BIANCO CALACATTA
GRIS EXPO	BLANCO MAPLE 14	ALUMINIO NUBE	BLANCO ORION	CLASSIC CALACATTA	ETERNAL CALACATTA GOLD
MARENGO	BLANCO NORTE 14	BIANCO RIVER	BLANCO ZEUS	ETERNAL EMPERADOR	ETERNAL NOIR
NOKA	CAMDEN	BLANCO CAPRI	CORKTOWN	ETERNAL MARFIL	
ROUGUI	CEMENTO SPA	BLANCO MAPLE	ETERNAL SERENA	ETERNAL MARQUINA	
	CORAL CLAY	BLANCO STELLAR	ICONIC BLACK	ETERNAL STATUARIO	
	IRONBARK	DESERT SILVER	KENSHO	ICONIC WHITE	
	MIAMI WHITE 17	LUSSO	LAGOON	PEARL JASMINE	
	NIGHT TEBAS 18	MEROPE	LYRA		
	NIEBLA	MIAMI VENA	NOLITA		
	WHITE STORM 14	ARIEL	POBLE NOU		
		SILKEN PEARL	SEAPORT		
		SNOWY IBIZA	UNSUI		
		STELLAR NIGHT	WHITE ARABESQUE		
		STELLAR GREY			
		TIGRIS SAND			
		YUKON			





Eternal Marquina

SILESTONE® Applications

Silestone® offers multiple applications for kitchens and bathrooms.

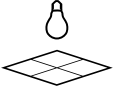
- 
 Kitchen Worktops

 Bathroom Worktops
- 
 Indoor Floors

 Bathroom Walls
- 
 Wall Cladding

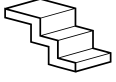
 Furniture
- 
 Stairs

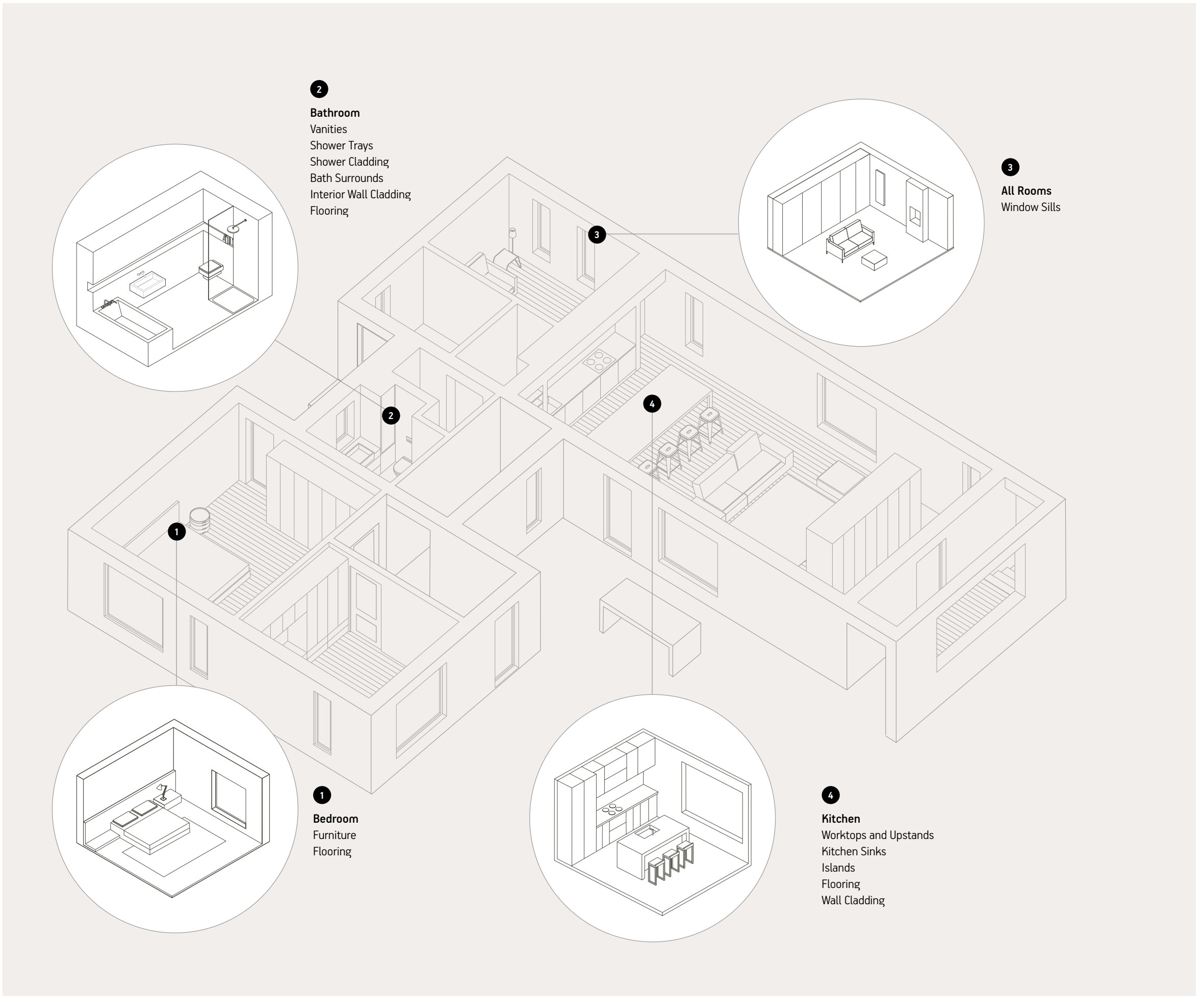

2
Bathroom
 Vanities
 Shower Trays
 Shower Cladding
 Bath Surrounds
 Interior Wall Cladding
 Flooring

3
All Rooms
 Window Sills

1
Bedroom
 Furniture
 Flooring

4
Kitchen
 Worktops and Upstands
 Kitchen Sinks
 Islands
 Flooring
 Wall Cladding

SILESTONE®
**Kitchen Worktops, Islands
 and Backsplashes**

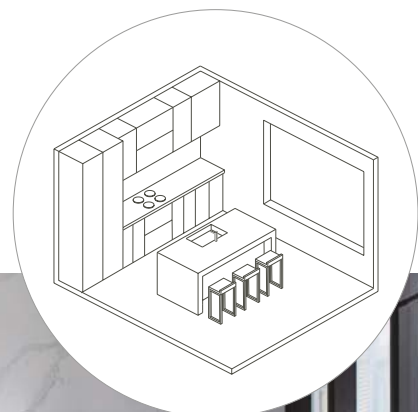

Silestone is a compound made up of 90% natural quartz, which make it extraordinarily hard and resilient. It is an excellent surface for kitchen worktops.

Silestone® is the only quartz surface with a 25 year warranty. It also offers a wide range of colours and textures to transform your kitchen into a unique space. Silestone® can be used in a variety of applications, including countertops, islands, backsplashes and window sills.

SILESTONE®
Integrity Sinks



Continuity and uniformity in kitchens are fashionable. Silestone offers a range of possibilities with its wide range of Integrity sink models.

No pieces, no creases, no limits. Integrity wants your kitchen to be whole; a place where there is no start or finish. Integrity gives you the sensation of unity, of perfect integration with the rest of the elements of your worktop.



Integrity DUE-L

Integrity DUE-S

Integrity DUE-XL

Integrity ONE

Integrity Q

Integrity TOP

SILESTONE®
**Flooring, Cladding, Tiles
 and Furniture**



Silestone® bespoke flooring and tiles are available in all colours and, unlike other products, can be used throughout the home offering low maintenance durability with a luxurious appeal.

Silestone's minimal maintenance requirements and low porosity make it the ideal product for rooms in which water is used and areas of high traffic. Environments with damp conditions or changes in temperature require flooring that offers outstanding performance. Silestone® not only meets these requirements, it exceeds them with the added benefit of attractive design.

Silestone® is the perfect material to use to clad kitchen cupboards or other furniture throughout the home. Creating beautiful complimentary pieces in all rooms.

SILESTONE®
Bathroom Solutions

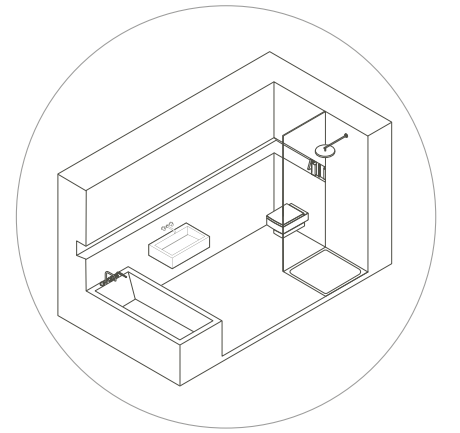

The Bathroom Collection by Cosentino is a unique concept in the specifier sector, based on the use of single materials that offer superior performance and remarkable beauty.

Silestone® is a surface made with up to 90% quartz and a range of more than 60 exclusive colours, it possesses the ideal characteristics for bathrooms.



Custom Design

The entire Bathroom Collection is custom-made to order, in any of the Silestone, colours.

The product is adapted to the space and needs of each client.



Large Format

One of the characteristics that makes the Bathroom Collection by Cosentino concept unique is its large format.

All the Cosentino® materials are manufactured in slab formats of more than 3 metres long by more than 1.4 metres wide. This enables us to cover the bathroom area with the smallest possible number of pieces, thereby obtaining greater continuity in design and better hygiene, due to the smaller amount of joints.



Wide Range of Colours and Textures

With the aim of being adapted to your style, Silestone offers you different textures to any of your chosen applications. Polished, Suede or Volcano are three possibilities that enable your imagination to fly.



Bathroom Vanities



Shower Trays



Bathroom Cladding



Bathroom Washbasins



Bathroom Flooring

SILESTONE® Washbasins

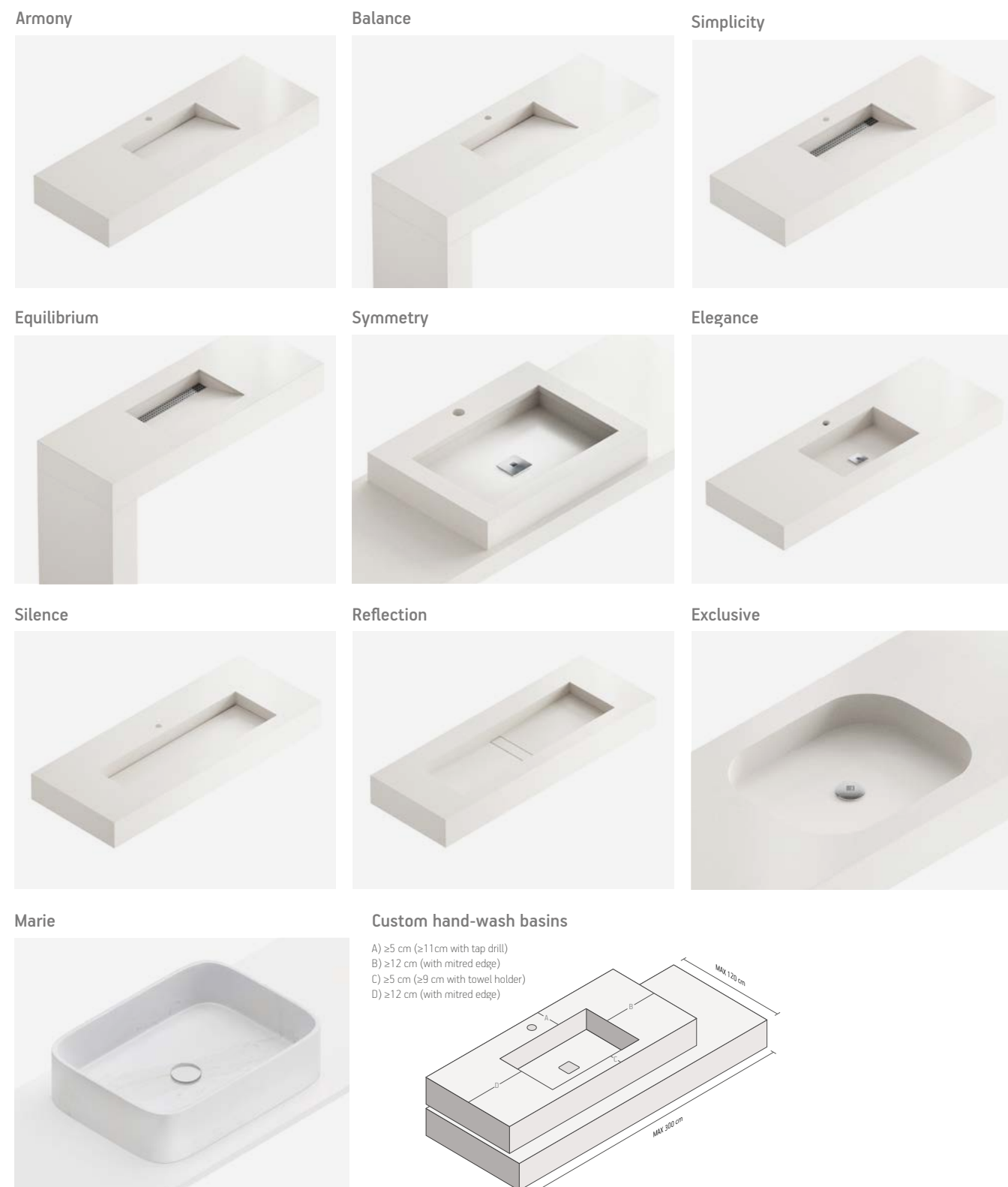

SILESTONE® Shower Trays

Silestone shower tray collection is based on an exclusive design that has revolutionised the bathroom sector. It offers flexibility in design, along with safety. Your shower tray can be adapted to your space.

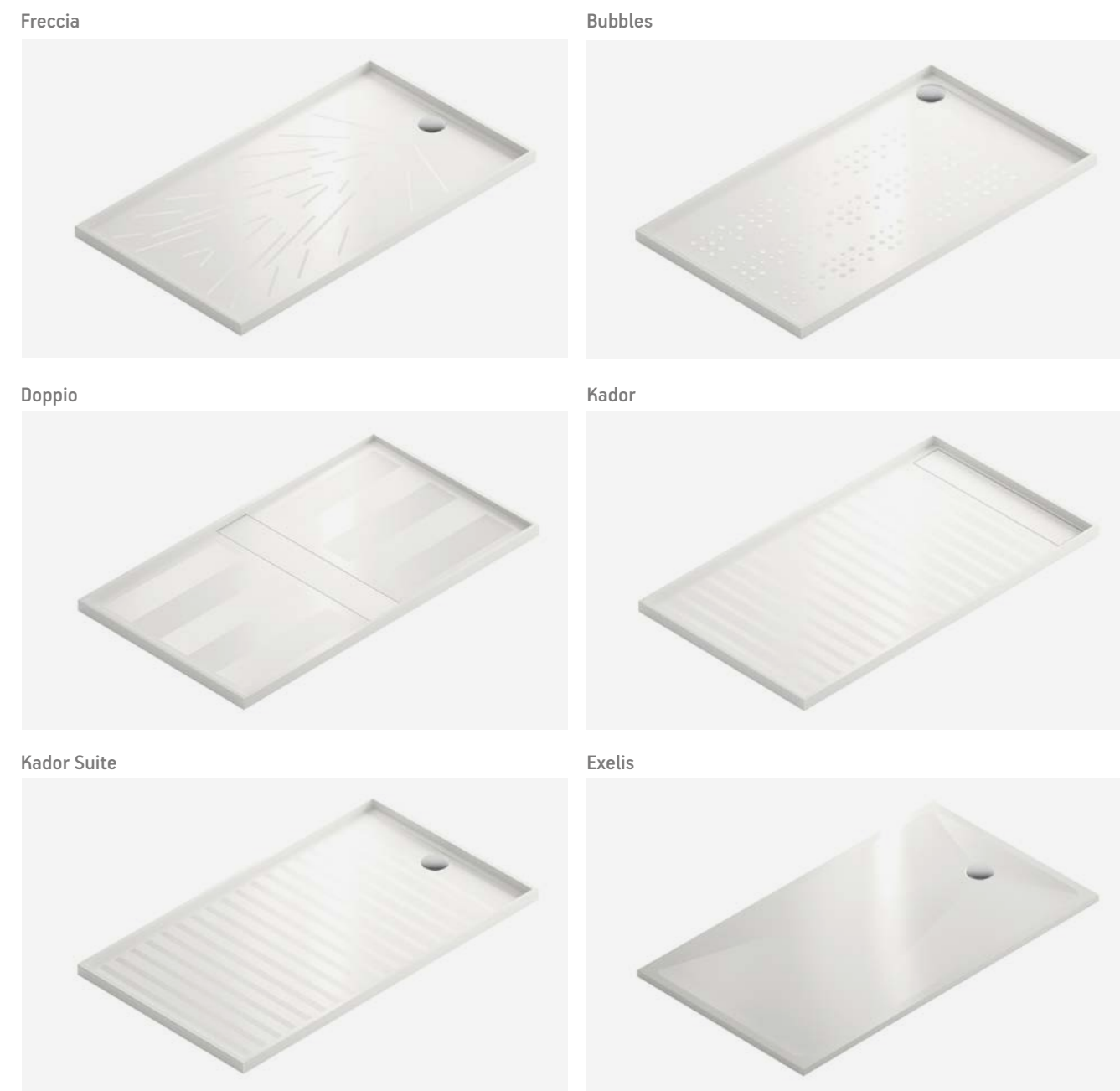

 **Shower trays with a soft sandblasted surface**
Surface available exclusively in the shower tray line for maximum antislip safety.

PRODUCT AND APPLICATIONS



The first Ultra-Compact Surface: Suitable for all applications inside and out

The accelerated replication of metamorphic changes endured by natural stone through exposure to high pressure and temperature of millenia.

Dekton® is an ultra-compact surface that consists of a sophisticated blend of the raw materials used to produce the very latest in glass and porcelain as well as the highest quality quartz worksurfaces.

Worktops, walls, vanities, flooring, shower trays, cupboard doors, exterior façades, patios and fire pits.

Whatever you need in a surface - from ONE material.



The unique brand that gives you a certified warranty

Dekton® is the only brand that offers a certified warranty, in writing. Only a global leader, one which is the largest producer of quartz surfaces, could once again draw ahead of the pack and offer a genuine 25-year warranty for Dekton.

Easy to register for residential projects



Visit the website for more information
www.cosentino.com/en-gb/dekton



The Perfect Material

Choice of material is crucial, because it plays a key role in structural stability, and can directly affect the energy efficiency of the building.

Cosentino offers materials of indisputable beauty, with features that make them unique in the market: their thickness and large format, superior UV resistance, stain resistance, colour fastness, and ability to withstand both high and low temperatures. These are just some of the essential properties of the ultra-compact Dekton®, the option chosen by thousands of professionals for interiors and exteriors.



Natura

DEKTON® Advantages



Highly UV resistant

Dekton® is highly resistant to ultra violet (UV) light and will not fade or degrade over time, making it perfect for both indoor and outdoor applications.



Multi-application product

Throughout the inside and outside, including façades.



Highly scratch resistant

Dekton® is the most scratch resistant surface on the market and while the slip of a knife won't damage Dekton®, cutting boards are still recommended to protect your household utensils.



Resistant to stains

While other surfaces are stain resistant, Dekton® is completely Stain Proof. Even the most stubborn stains like wine, coffee, markers and rust can easily be removed from the surface. Since Dekton® has extremely low porosity and contains no resins, it is chemically resistant.



Maximum resistance to fire and heat

Dekton® withstands high temperatures without burning, scorching or cracking. Hot Pots and appliances like Crock Pots can be placed directly on the surface with no worry of damage.



Resistance to abrasion

Dekton® is even more resistant to abrasion than granite, making it the ideal surface for commercial applications and high traffic areas such as flooring. While other surfaces show wear over time, Dekton's finish will last for the life of the product and never needs to be re-surfaced or re-finished.



Resistance to freezing and thawing

Dekton's low coefficient of thermal expansion makes it Thermal Shock proof from both extreme heat and extreme cold. It's natural resistance to ice and thawing makes it perfect for use in even the coldest environments.



Superior mechanical resistance

With over 5 times the flexural strength of granite, Dekton® can be installed in thinner material over greater spans allowing for up to a 12-inch unsupported overhang on worktops, islands and bartops. Dekton's high compressive strength makes it an ideal material for walkways, pavers or driveways.



Low water absorption

Dekton® is non-porous and never needs to be sealed. It naturally prevents liquids and gasses from penetrating the surface, making it a low maintenance surface that is easier to clean.



Colour stability

The manufacturing process used to make Dekton® allows us control the pigmentation and decoration of the material giving better colour consistency from slab to slab and resulting in a long lasting product that will not fade over time. The surface you install today will maintain the same new appearance for the life of the product.



Dimensional stability

Dekton® is very consistent in both dimension and thickness throughout the slab which minimizes the need for field corrections and allows for easy installation.



Fireproof material

Quartz is one of the hardest minerals in the world. This makes our products very durable, with a high level of resistance to external aggressions.

DEKTON® Collection

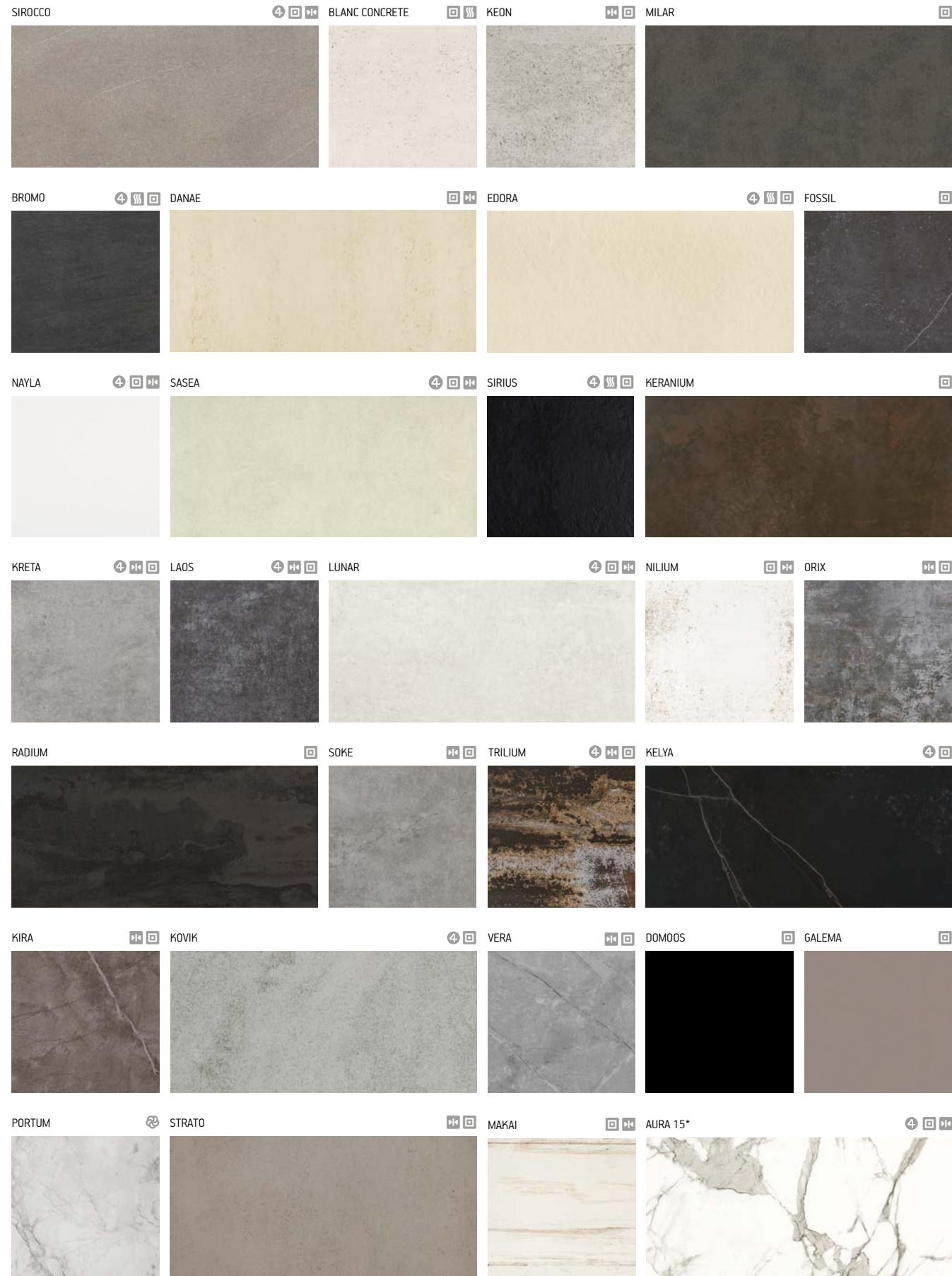

*AURA15 is available as bookmatch

DEKTON® Collection

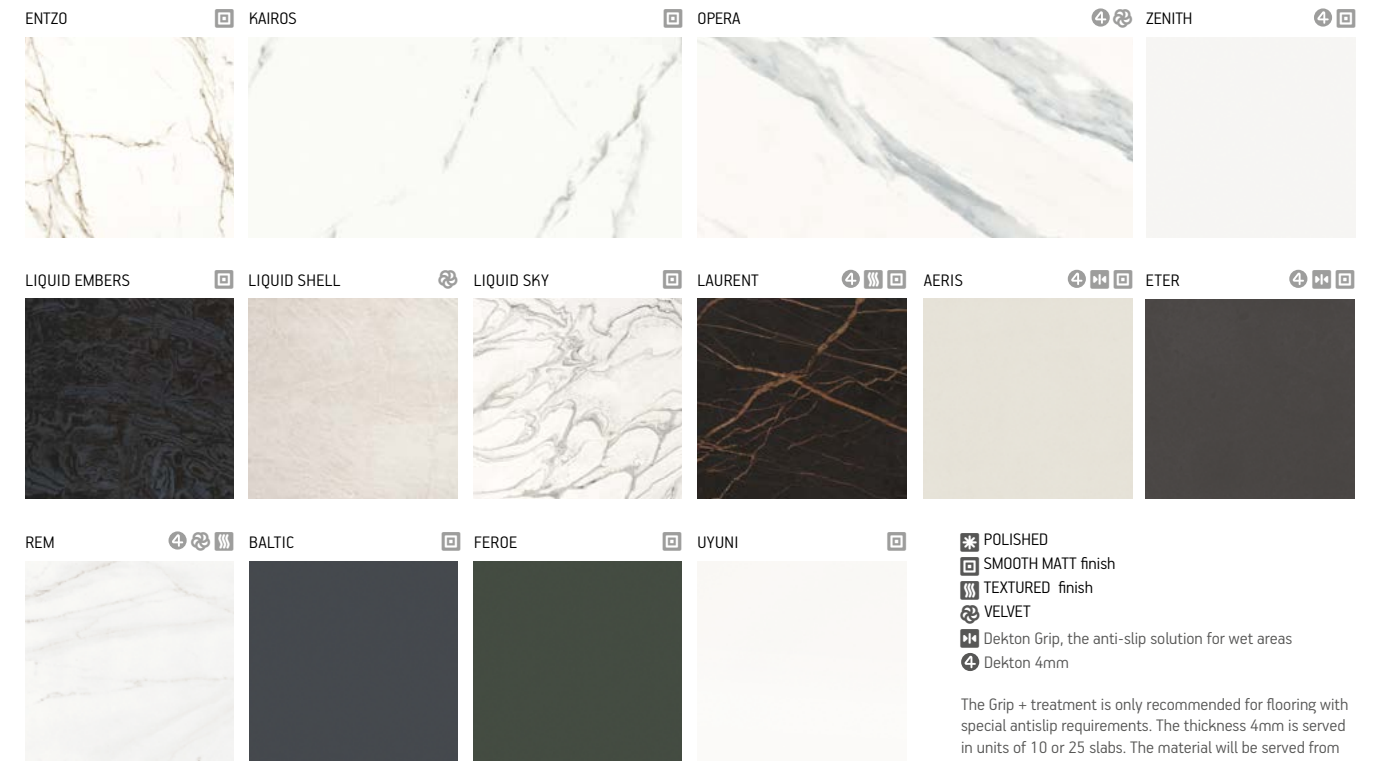

- POLISHED
- SMOOTH MATT finish
- TEXTURED finish
- VELVET
- Dekton Grip, the anti-slip solution for wet areas
- Dekton 4mm

The Grip + treatment is only recommended for flooring with special antislip requirements. The thickness 4mm is served in units of 10 or 25 slabs. The material will be served from Cosentino Central HQ, see delivery terms.

DEKTON® XGloss

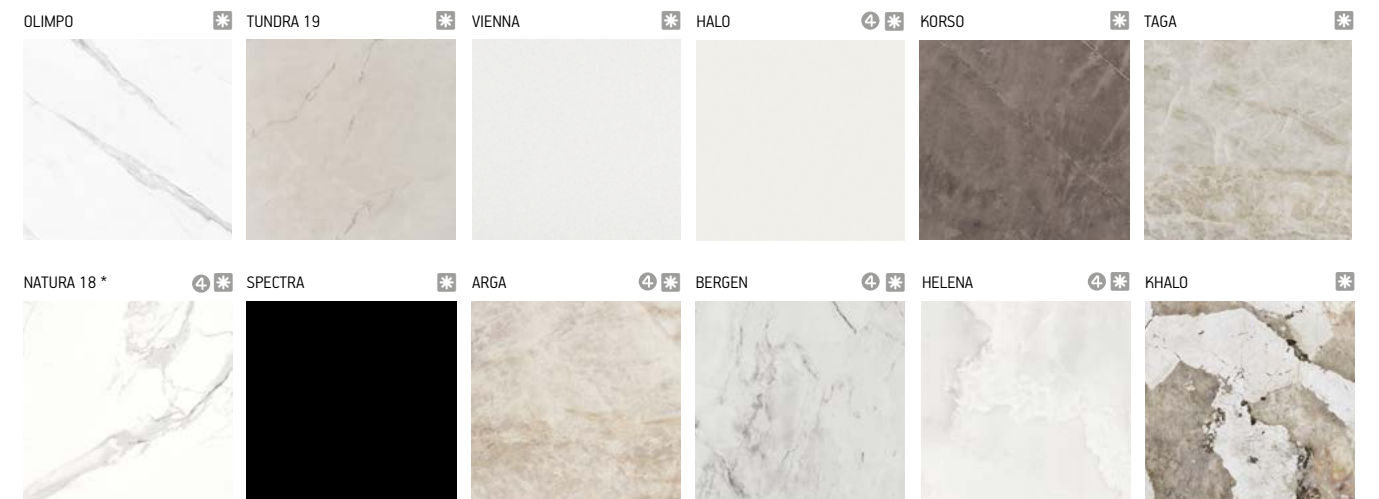

*NATURA18 is available as bookmatch

DEKTON®
Collection

GROUP 0	GROUP 1	GROUP 2	GROUP 3	GROUP 4
AERIS	BROMO	KRETA	AURA 15	AURA 15 BOOKMATCH
ETER	EDORA	KAIROS	BALTIC	
SIROCCO	FOSSIL	LAOS	ENTZO	
BLANC CONCRETE	NAYLA	LUNAR	FEROE	
KEON	SASEA	NILIUM	LAURENT	
DANAE	SIRIUS	ORIX	LIQUID EMBERS	
MILAR	KEON	RADIUM	LIQUID SHELL	
STRATO	KERANIUM	SOKE	LIQUID SKY	
	MAKAI	TRILIUM	OPERA	
		KELYA	REM	
		KIRA	UYUNI	
		KOVIK		
		VERA		
		DOMOOS		
		GALEMA		
		VENTUS		
		ZENITH		

DEKTON®
XGloss

GROUP 2	GROUP 3	GROUP 4
VIENNA	KORSO	HALO
	NATURA 18	HELENA
	TUNDRA 19	KHALO
		NATURA 18 (BOOKMATCH)
		OLIMPO
		SPECTRA
		ARGA
		TAGA
		BERGEN

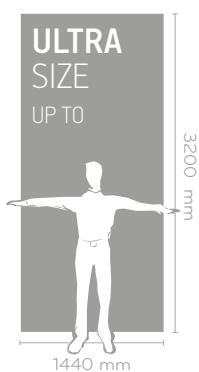

DUE TO ITS INTENSE SHINE DEKTON XGLOSS REQUIRES SPECIAL MAINTENANCE AND CARE, PARTICULARLY WITH THE DARKER SHADES, SUCH AS SPECTRA, WHERE ITS INTENSE BLACK COLOUR CAN REVEAL SMALL DETAILS.

The provided samples don't guarantee that the supply will be absolutely identical in tone and veins. See General Conditions of Sale.





DEKTON® Applications

Dekton® offers multiple applications for both indoors and outdoors. Facades, countertops, heavily trafficked floors, etc...

- 

Kitchen Worktops



Bathroom Worktops
- 

Outdoor Worktops

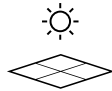

Outdoor Terrace Floor Coverings
- 

Exterior Walls

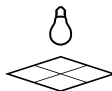

Indoor Floors
- 

Exterior Facades

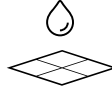

Bathroom and Pool Floor Coverings
- 

Bathroom Walls

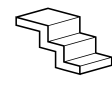

Stairs

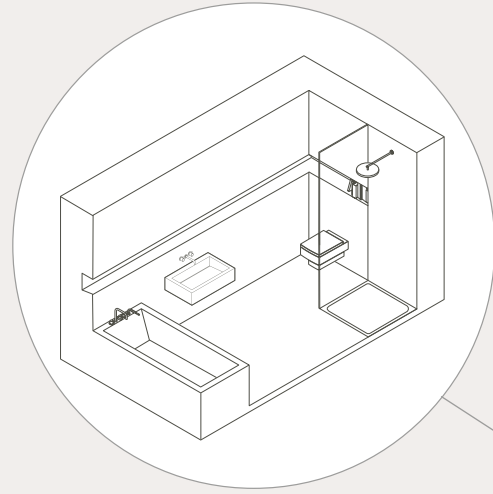

- 2**
Bathroom
Vanities
4mm Cupboard Cladding
Shower Trays
Shower Cladding
Bath Surrounds
Interior Wall Cladding
Flooring

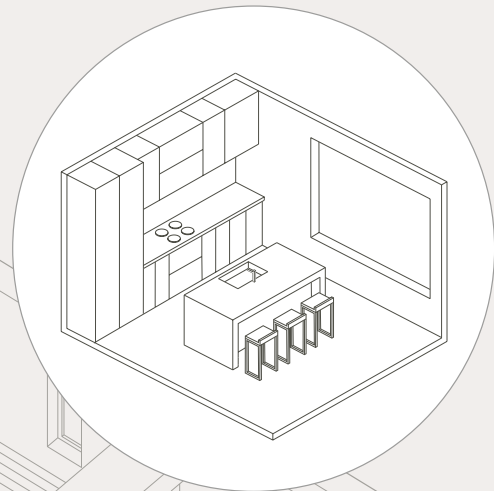

- 3**
Kitchen/Dining
Worktops and Upstands
Islands
4mm Cladding
Dining Table
Flooring
Window Sills

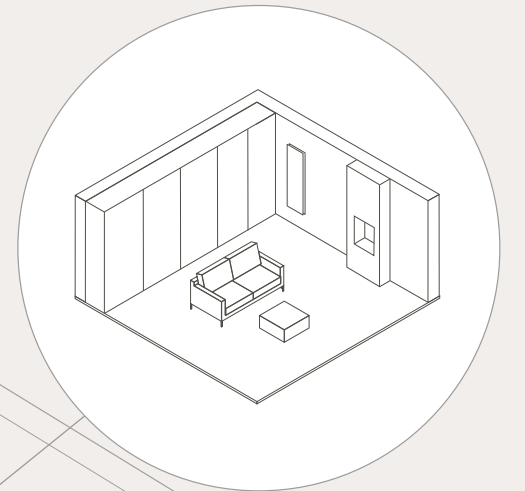

- 4**
Sitting Room
Furniture Cladding
Fireplaces
Feature Wall Cladding

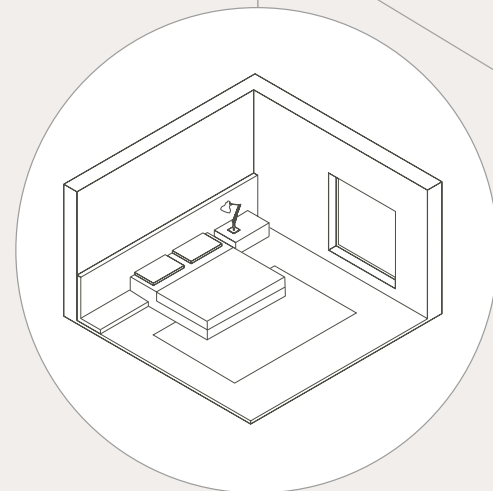

- 1**
Bedroom
Furniture Cladding
Bedside Table
Wardrobe Doors

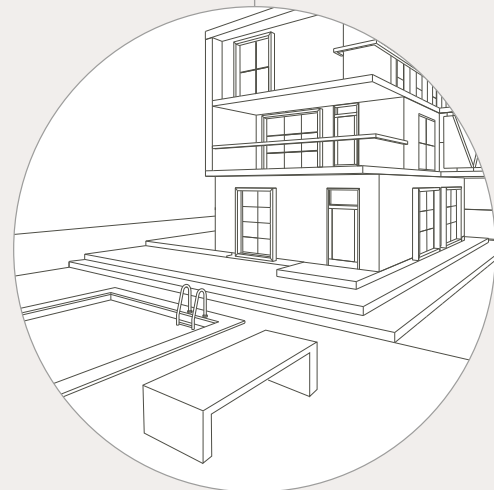

- 6**
Exterior
Outdoor Worktops
Patio/Swimming Pools
Fire Pits
Exterior Facade
Flooring
Front Door

- 5**
All Rooms
Stairs
Window Sills

DEKTON®

Kitchen Worktops, Islands, Cladding and Window Sills

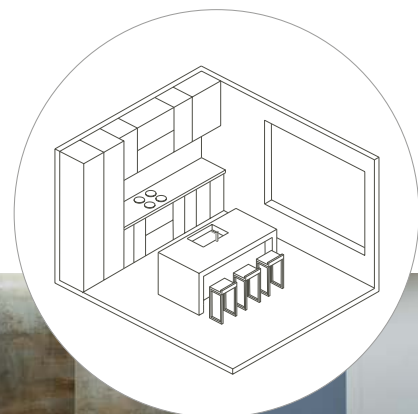

Dekton® is a long-term product for those looking to turn their kitchens into a unique space.

Firstly, because it allows you to have installation in one piece with fewer cuts and joints, no limits just the appeal of a completely uniform surface, which fits seamlessly into very different design styles.

Dekton® combines the qualities desired by the chef in all of us. It is a clean surface that is nice to touch and resistant to the daily grind that takes place in a kitchen over the years. An ultra-sophisticated material for busy everyday life, capable of creating a space that makes the preparing of food, day after day, a pleasant experience that precedes the pleasure of sharing

a meal with friends or family. It represents beauty and solidity with easy fuss-free cleaning. The structural density of Dekton® is a break-through in engineering, but what really matters is that we do not have to worry about scratches, stains or traces of heat. A simple wipe with a cloth and hey presto! Because the kitchen should be enjoyed with no restrictions, this is the Dekton® way of thinking.

Dekton® can be used in a variety of applications, including countertops, islands, backsplashes and window sills.



DEKTON®
**Flooring Solutions
 and Tiles**



Dekton's superior technical characteristics offer excellent resistance to scratches and abrasion and therefore can be used in high traffic areas. Dekton's unique resistance to UV rays allows for colour stability and exceptional performance in outdoor spaces. Due to its ability to resist heat, frost and thawing, the product can be used outdoors in all weather conditions. This powerful combination allows for the ability to design without limits.

Dekton tiles are available in 0.8 CM and 1.2 CM thicknesses and the following slab sizes

-
- 71 X 71 CM
-
- 71 X 142 CM
-
- 142 X 142 CM
-
- 79 X 143 CM
-
- 106 X 71 CM
-
- 106 X 143 CM
-
- 159 X 71 CM
-
- 159 X 143 CM
-

Dekton® is a blend of raw materials, that undergo a unique technological process known as Particle Sintering Technology, which is an accelerated version of the metamorphic changes that occur when natural stone is exposed to high pressure and temperature for thousands of years. The Dekton® press is 25,000 tons, the largest in the world, which makes the stone into an ultra-compact surface of an unprecedented size and

thickness, ensuring extreme performance. This level of compaction contributes significantly to the low porosity of the material, making it a long lasting product that requires minimal maintenance.

- ▶ The thickness and format depends on the project.
- ▶ This cut to size rate is not applied in Aura 15 Bookmatch.
- ▶ Ask for different formats.
- ▶ For the installation ask for the guidelines.
- ▶ Material by order. Please ask for minimum quantities.
- ▶ In some references, it should be taken into account both the directionality of the texture/decoration and the movement of the background. A redesign is recommended either flooring or maintenance of directionality. Colours: Aldem, Arga, Aura15, Bergen, Blanc Concrete, Bromo, Danae, Entzo, Fiord, Gada, Glacier, Kairos, Kelya, Keon, Kira, Korso, Makai, Natura 18, Nillium, Laos, Opera, Orix, Radium, Soke, Soqne, Taga, Trilium, Tundra, Vera.

▶ **Anti-Slip treatment - Available upon request with extra cost**

DEKTON®
**Outdoor Surfaces
 and Furniture**

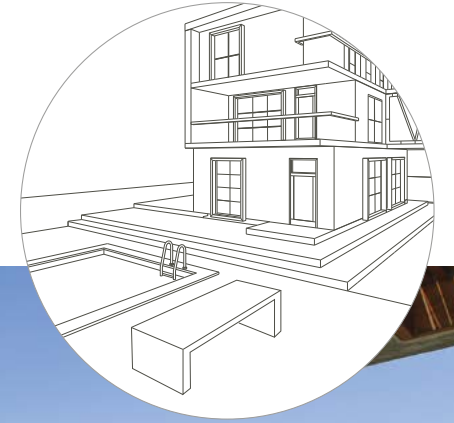

Cooking is definitely a pleasurable experience and doing it outdoors, usually results in a small social event. Everyday celebrations that we can enjoy with company around a grill. Dekton®, due to its ultra-compact structure, is particularly suitable for installations for outdoor kitchens and barbecues.

Dekon® provides strength and style to these spaces, it gives them an undeniable personality and unlimited practicality. Stains, bumps, utensils at high temperature... Dekton® will resist the demanding use over time while maintaining its unchanging beauty.

It is not affected by ice, sleet, or wind either. When bad weather arrives, Dekton® simply needs effortless and fuss-free cleaning so that it can showcase its best again.

DEKTON®
Façades

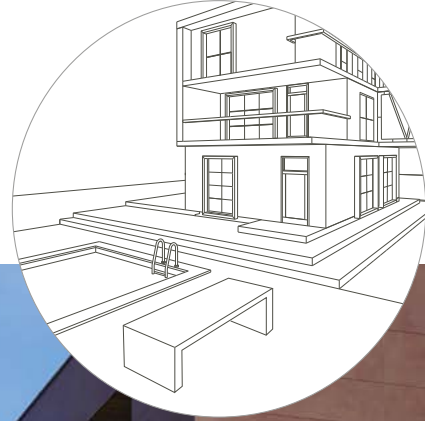

Dekton® is available in large format panels with minimum thickness, rewriting the rules of what is possible with ultra-compact surfacing materials. Dekton® panels measure 1400mm x 3200mm with a thickness range of 8mm to 30mm. Aside from the advantage of its size capabilities, Dekton® is highly resilient and can be installed as part of ventilated rainscreen system, or, due to its remarkable durability and low moisture absorption, installed as a direct adhere façade, similar to dimensional stones like granite.

Dekton® is the architect's choice when unlimited surface and space designs are required, where color and texture flow freely in all directions inside and out, expressing itself in all of its fullness and versatility.

High Performance
 All Purpose Façades
 Designing Without Limits

- Large Format Panels:**
 1400mm x 3200mm
- Thickness:**
 8mm, 12mm and 20mm
- Flexural strength
 - Excellent dimensional stability
 - Resistance to freezing and thawing
 - Unmatched colour stability



BBA CERTIFIED:
 DEKTON FAÇADE RAINSCREEN CLADDING

DEKTON®
**Natura and
 Aura Bookmatch**



With Natura and Aura we have evolved from a single slab design to an endless symmetrical pattern. With 8 unique designs, we can reproduce matching compositions that allow continuous vein matching from slab to slab.

Natura and Aura is matched vertically and horizontally: We have a system with letters and numbers so you can select the pattern that best fits your needs. Notice that you can choose different combinations depending on the amount of vein you would like in your design. You may also choose from vertical or horizontal matching as well as traditional mirror book-matching effect or vein matching.

DEKTON® SLIM

Everything is easier with Dekton® Slim



Thanks to its light format with an array of possibilities, everything just got a lot simpler. Its reduced thickness means it can be cut quickly and adjustments can be made on-site with tools for ceramic tiles. Dekton Slim is a material without internal tension, so it is not necessary to release it by cutting it. With a lightness of 10 kg/m², it is so easy to install.

It is important to read and familiarise yourself with the safety measures in order to handle construction materials.



Easy to Cut and Create



Easy to Handle and Transport



Easy to Install



Personalised Customer Service



At Cosentino we offer **personalised Customer Service**. Ask as many questions you like and request all the advice you need to ensure you get exactly what you want out of the new Dekton® Slim.

Find your nearest Cosentino Centre at www.cosentino.com

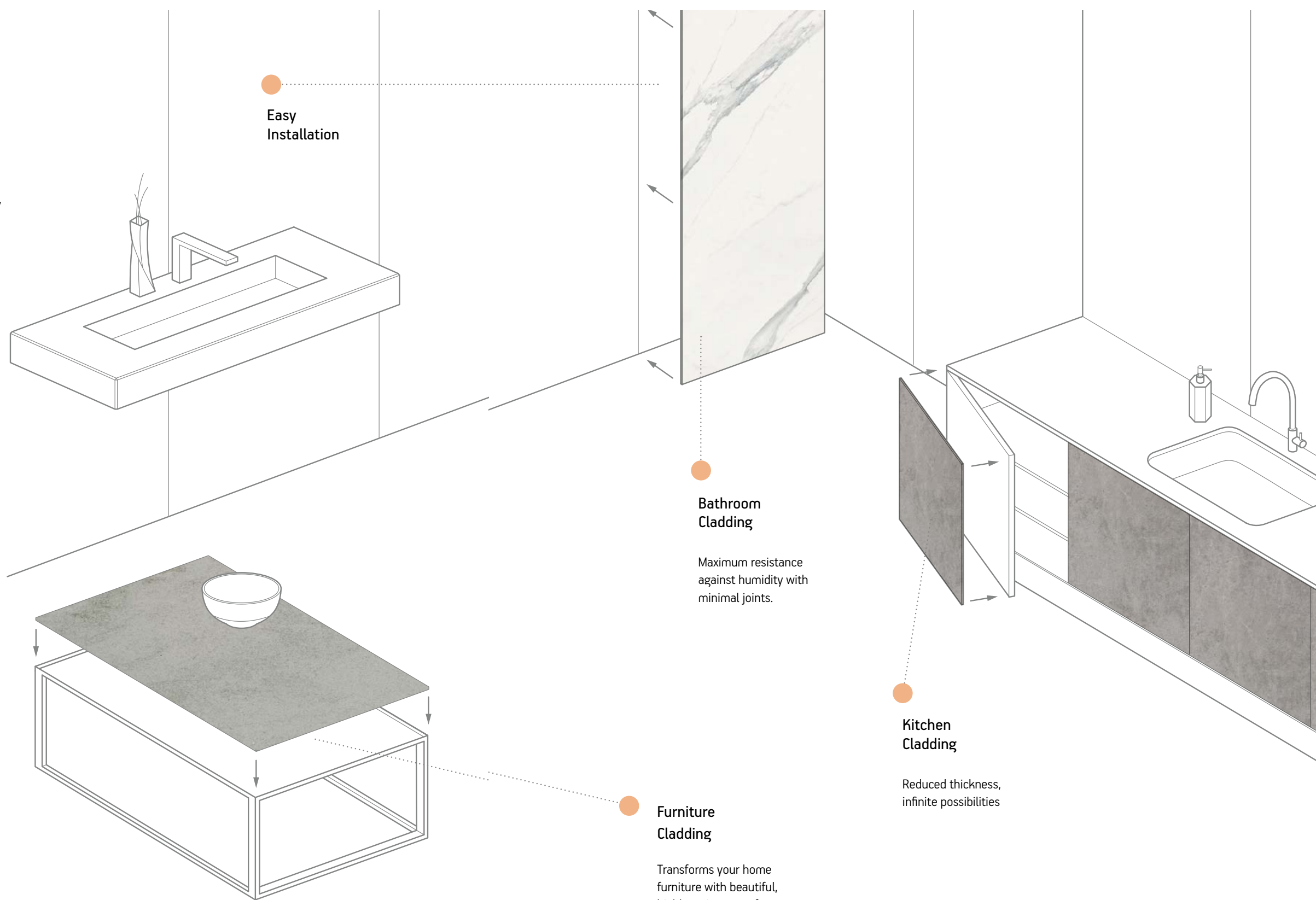

Colours

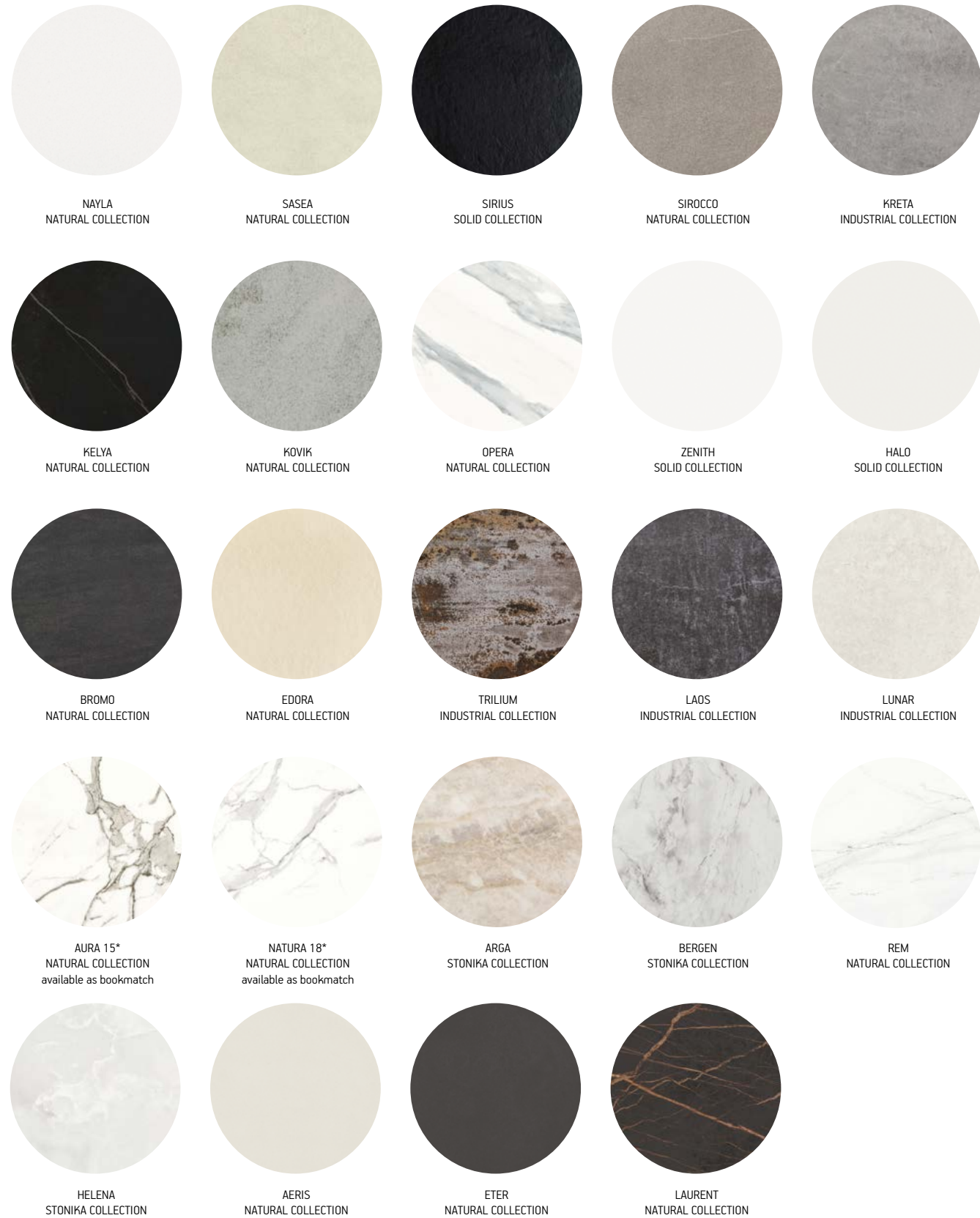

designed by COSENTINO®



Introducing 'Dekton Slim', the new thickness of Ultra-Thin 4mm pieces, which offers unlimited design options. Its lightness and reduced thickness make it the most durable and high-performance cladding surface, ideal for furniture, tables, cabinet doors, drawers or interior wall cladding.

This new format maintains the same properties as other Dekton® formats, high durability and resistance against stains, scratches and extreme temperatures. Moreover, it is also available in slab size of 3200x1440mm.

Discover more on www.dekton.com/slim

The 4mm thickness is served in units of 5 slabs or 10 mono-colour slabs. The material will be served from the Cosentino HQ, see delivery times

DEKTON® Bathroom Solutions

The Bathroom Collection by Cosentino is a unique concept in the specifier sector, based on the use of single materials that offer superior performance and remarkable beauty.

Dekton® is a surface with extraordinary properties of durability, design and suitability and a range of more than 40 colours, it possesses the ideal characteristics for bathrooms.

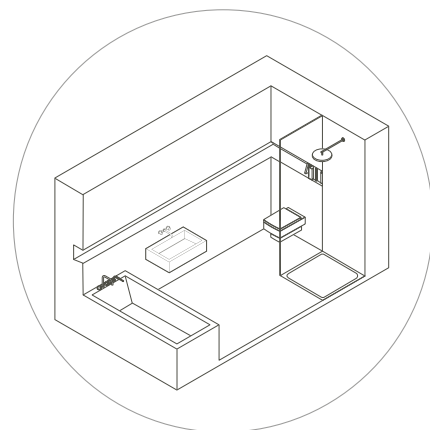

Custom Design
Along with standard models and formats - bespoke and custom-made materials are available on request



Large Format
One of the characteristics that makes the Bathroom Collection by Cosentino concept unique is its large format.

All the Cosentino® materials are manufactured in slab formats of more than 3 metres long by more than 1.4 metres wide. This enables us to cover the bathroom area with the smallest possible number of pieces, thereby obtaining greater continuity in design and better hygiene, due to the smaller amount of joints.



Wide Range of Colours and Textures
Ideal for washbasins, and all types of bathroom cladding, particularly now with the added choice of Dekton Grip Plus and Dekton Slim.



Bathroom Vanities



Bathroom Cladding



Bathroom Washbasins

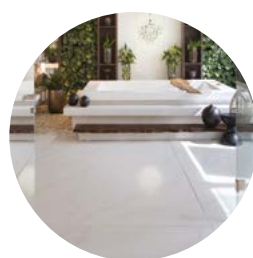

Bathroom Flooring

DEKTON® Washbasins

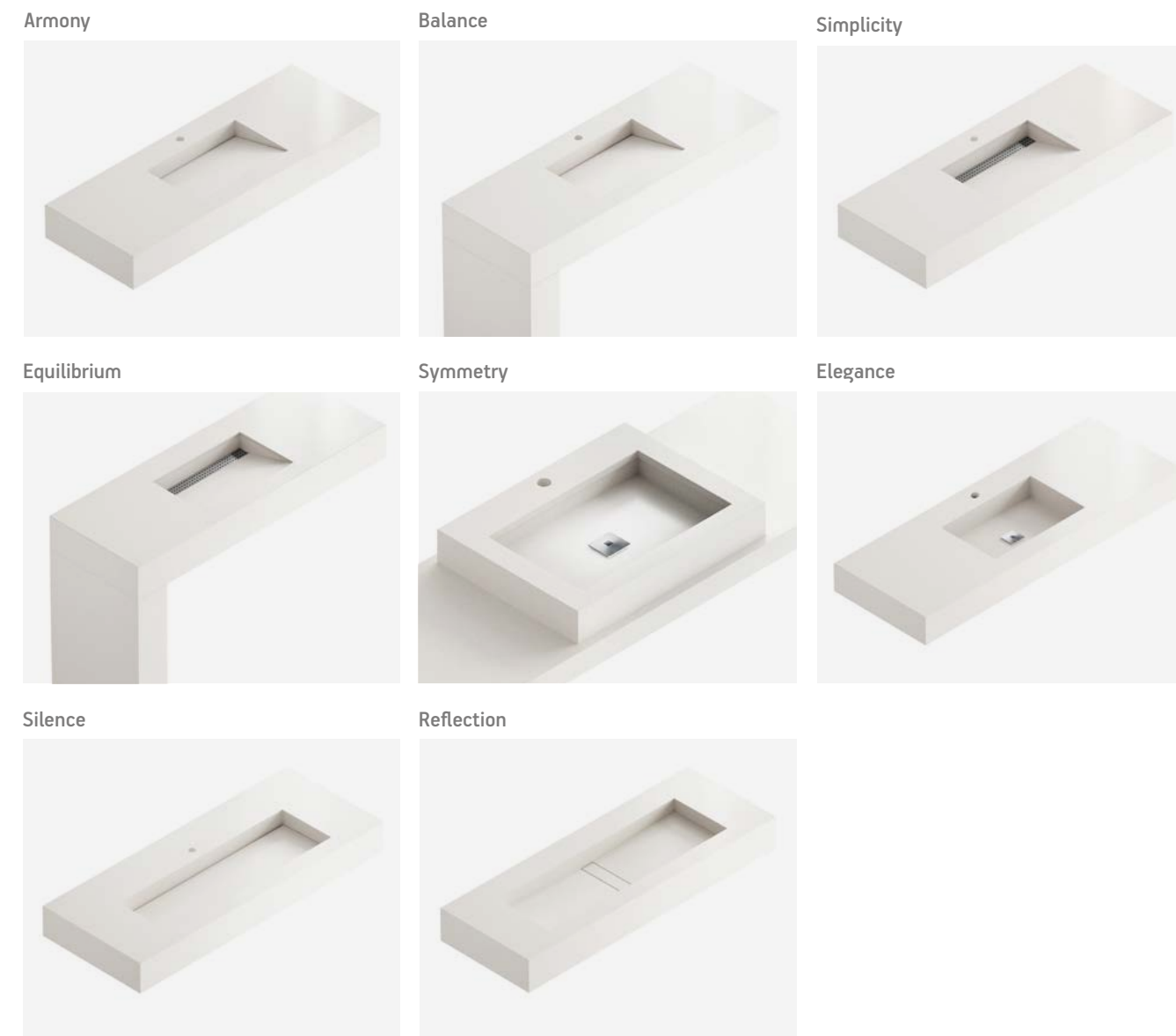

Custom hand-wash basins

- A) ≥5 cm (≥11 cm with tap drill)
- B) ≥12 cm (with mitred edge)
- C) ≥5 cm (≥9 cm with towel holder)
- D) ≥12 cm (with mitred edge)

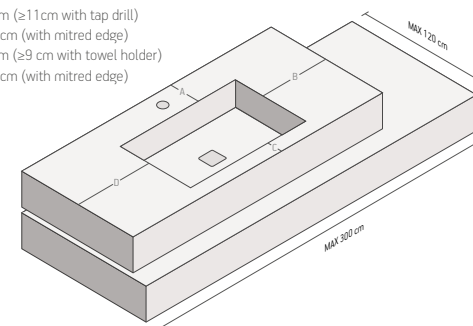

DEKTON GRIP +

Grip+ is a new surface product that modifies the visible face of the material in a scientific manner, creating a lightly textured surface that gives the product its anti-slip property. It retains the pleasant feel of standard Dekton® and has significant anti-slip properties. Dekton Grip + is available in the following colours.

Colours that can be used for ALL applications (except stairs): **Orix, Vera, Kreta, Soke, Keon, Aeris, Danae, Eter and Sasea**

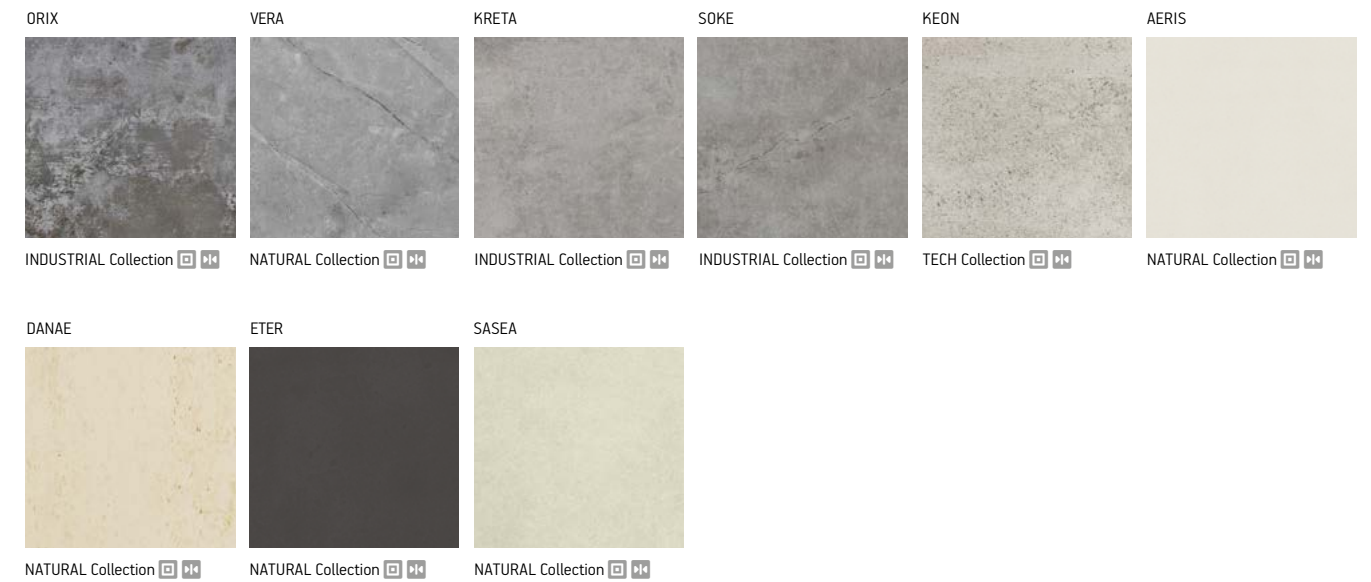

Colours that can ONLY be used for flooring with barefoot use (swimming pools/Spas): **Orix, Vera, Kreta, Soke, Keon, Aeris, Danae, Eter, Sasea Laos, Trilium, Kira, Strato, Danae, Nilium, Lunar, Sirocco, Nayla, Aura 15, Makai**

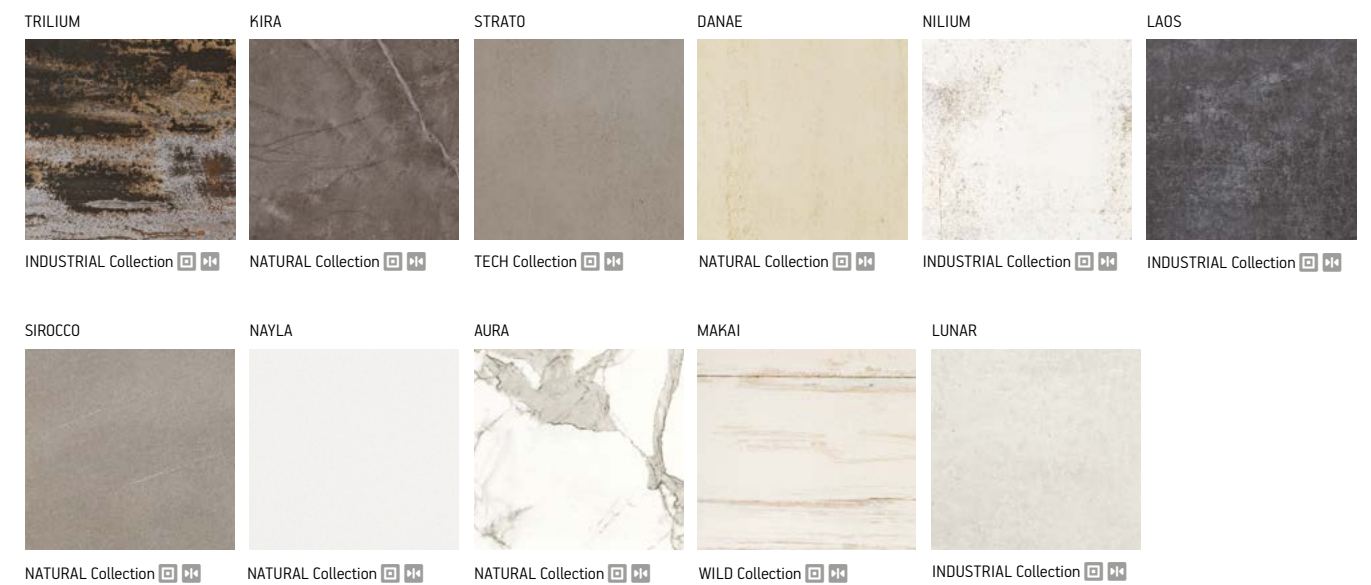



PRODUCT AND APPLICATIONS



Protected granite worksurfaces

Every Sensa slab is different with unique veining in each piece.

With an innovative treatment, which gives greater protection against stains for Granite worktops, Sensa by Cosentino can also withstand very high temperatures and is water and oil resistant. The two and three cm thick granite worksurfaces can be used inside and outside, as they are UV resistant and sunlight will not affect the colour of the surface.

SENSA
15 YEARS
WARRANTY

**The unique brand
that gives you a
certified warranty**

A protective treatment is applied to each slab of Sensa by Cosentino® in Cosentino's modern facilities. This protective treatment has a 15-year warranty that will allow you to continue to enjoy the natural beauty of your Sensa by Cosentino® countertop for a long time.

**Easy to register for
residential projects**



Visit the website for
more information
www.cosentino.com/en-gb/sensa

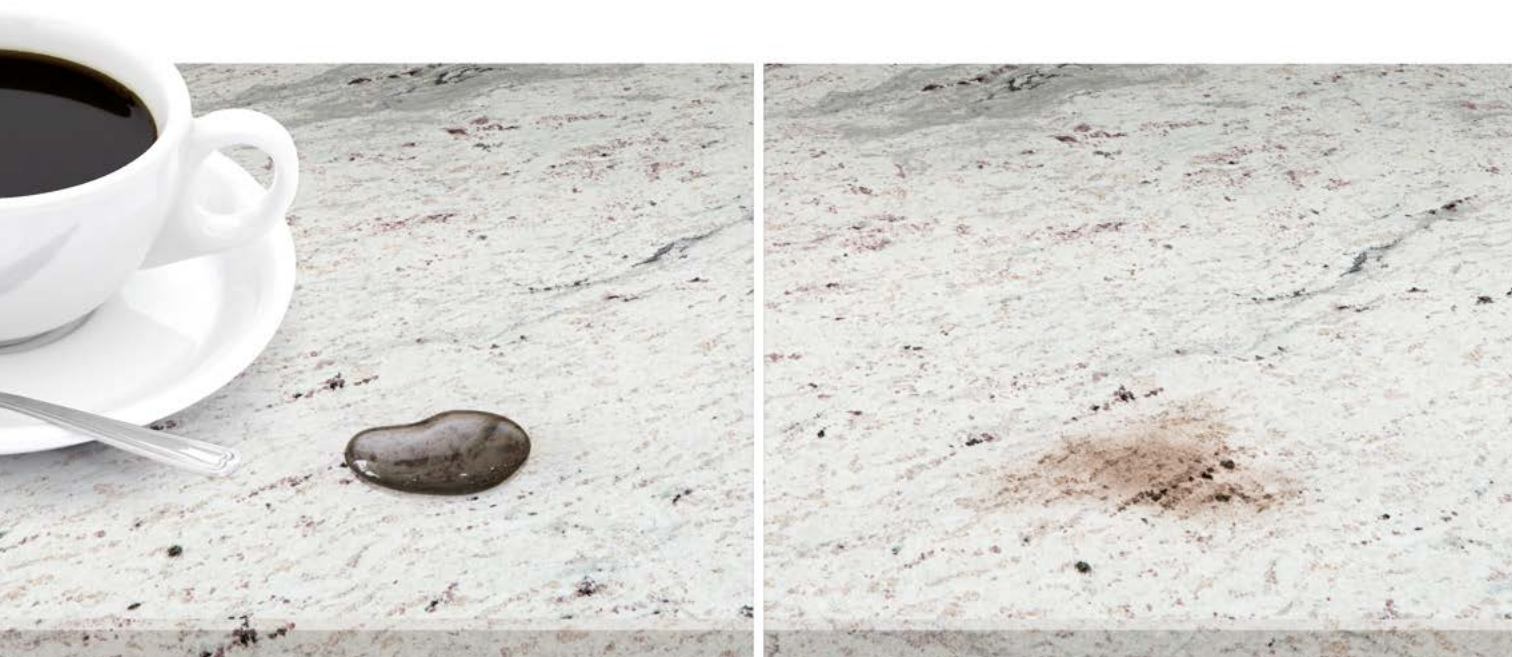

WITH SENSА

WITHOUT SENSА

Senguard is an invisible treatment with a long lasting result. It is chemically integrated into the material whilst allowing it to breathe and retain its natural beauty

The process alters the surface tension of the stone, preventing the penetration of liquids such as water, coffee and even oil

SENSА Benefits

Anchored to the surface of the stone, the stain protection prevents the granite from staining, whilst allowing the stone to breathe and preserve its natural colour. Sensa by Cosentino worktops do not need to be sealed and come with a 15 year guarantee.



Excellent Stain Resistance



No Special Maintenance Required



Certified and Approved for Direct Contact with Food



Unique Designs Created by Nature



High Performance and Quality with a 15 year warranty



ENDLESS BEAUTY

Protected Natural Stone



WHITE MACAUBAS PREMIUM COLLECTION

SENSA
15
YEAR
WARRANTY

The beauty and properties of Sensa's natural stone remain unchanged thanks to its innovative invisible protection against stains, preventing liquids such as oil or coffee from entering the material.

Surfaces with unique and exclusive designs created by nature with the best anti-stain treatment.



SENSA

Regular

SENSA
by COSENTINO®

SENSA

Collection and Finishes

We travelled all the way to Brazil and India to find the most beautiful stone that Nature can create. This stone was chosen following strict criteria of aesthetic excellence that resulted in unique, elegant surfaces with an exotic, yet subtle, touch. Unique. The adjective is well-chosen.

Sensa by Cosentino® offers you a range of colours to combine with any decor scheme or project.

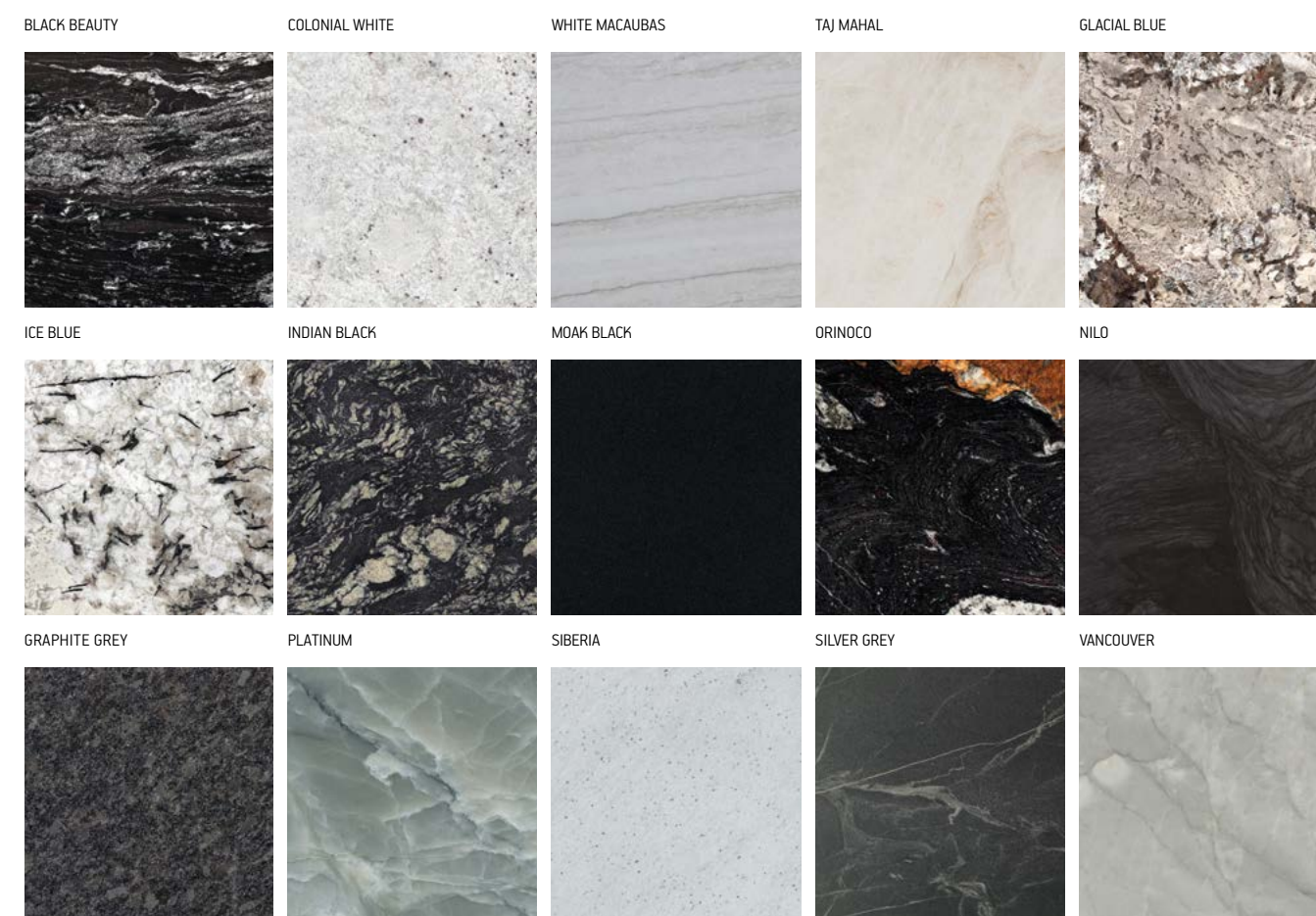

DESCRIPTION	FINISH
	2CM AND 3CM
BLACK BEAUTY	CAS
COLONIAL WHITE	MIR
GLACIAL BLUE	MIR
ICE BLUE	MIR
INDIAN BLACK	MIR
MOAK BLACK	SUE
ORINOCO	MIR
TAJ MAHAL	MIR

DESCRIPTION	FINISH
	2CM AND 3CM
WHITE MACAUBAS	MIR
NILO	MIR
GRAPHITE GREY	CAS
PLATINUM	SUE
SIBERIA	MIR
SILVER GREY	MIR
VANCOUVER	SUE

CAS - Cresse > brushed and polished
MIR - Mirage > polished
SUE - Suede

The provided samples don't guarantee that the supply will be absolutely identical in tone and veins. See General Conditions of Sale.

SENSA Applications

Sensa is a maintenance free premium Natural Stone brought to you by Cosentino® a world leader in the natural stone industry.



Kitchen Worktops



Bathroom Worktops



Outdoor Worktops

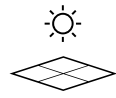

Outdoor Terrace Floor Coverings

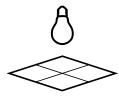

Indoor Floors

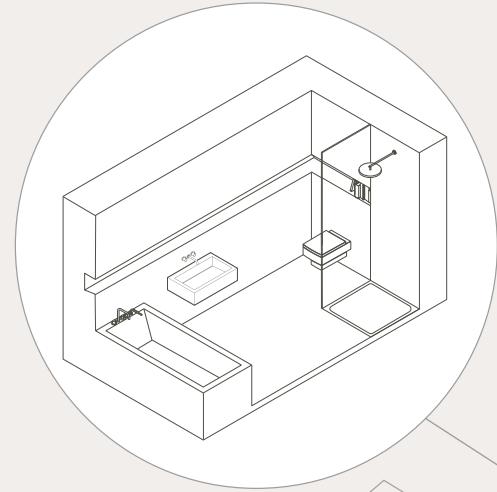

1
Bathroom
Worktops
Flooring

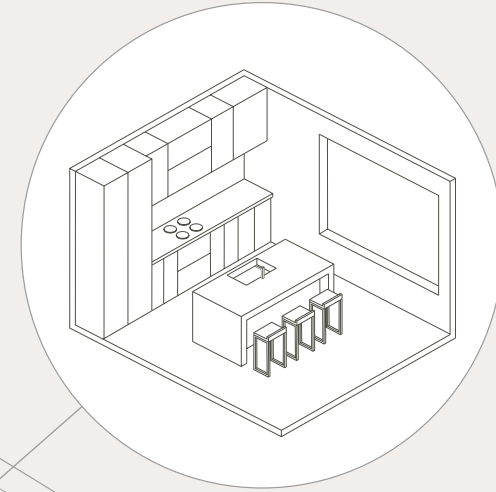

2
Kitchen
Worktops and Upstands
Islands
Flooring

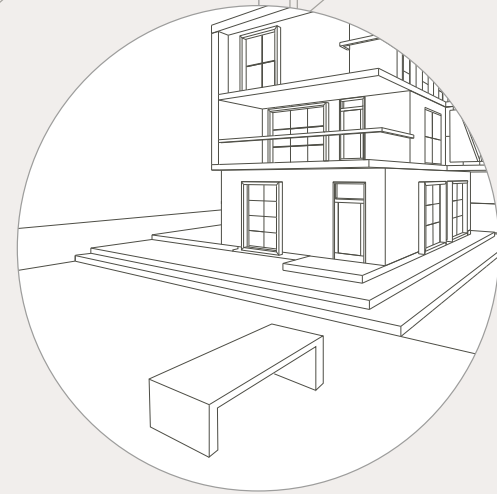
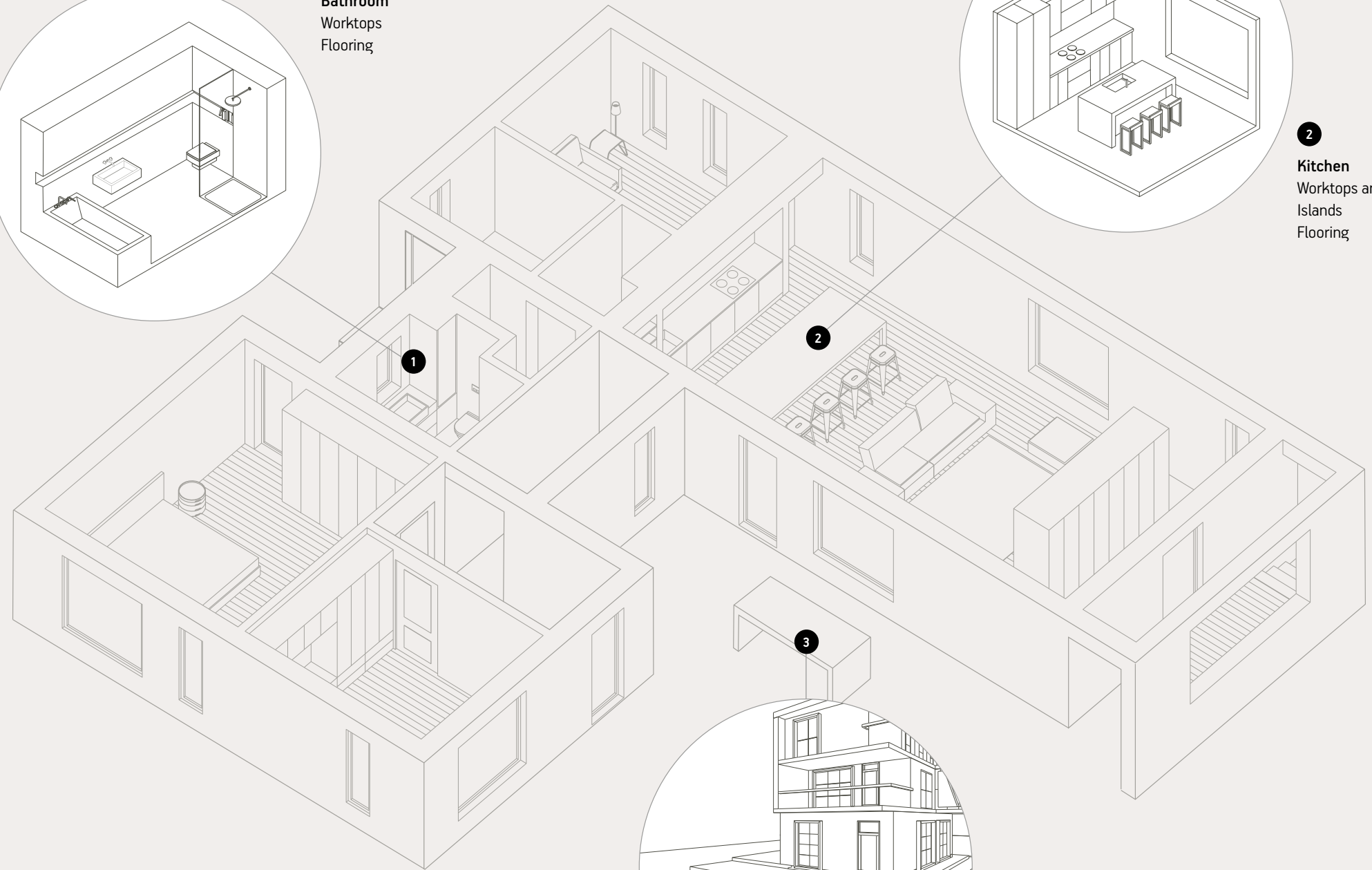

3
Exterior
Outdoor Worktops
Flooring

SENSA

Kitchens & Bathrooms



Sensa by Cosentino® offers high quality, durability and stain resistance that makes it an ideal choice for your kitchen or bathroom.

One of the common downsides of granite is porosity. This means that coloured liquids such as wine and coffee can stain the surface, and it can be scratched and damaged if not looked after properly. Some suppliers will provide products that can coat and protect the surface, but these tend to last around a year, so require re-application, and many daily cleaning products can remove the protection easily.

The ultimate protection

What if you still want granite, but don't want to compromise on resistance? Well, Sensa by Cosentino is not just granite - it's specially protected so that it actively repels stains. This protection doesn't change the naturally beautiful appearance of the stone, it simply gives added peace of mind that kitchen and bathroom surfaces will look good for many years to come. Protection on the inside, beauty on the outside.

General Terms and Conditions

SCOPE OF GENERAL TERMS AND CONDITIONS

All contracts between Cosentino UK Ltd. ("the Company") registered at Unit 10 Bartley Point, Osborn Way RG27 9GX, Hook, Hampshire and the person, firm or company who accepts the quotation from the Company for the sale of the goods or whose order of the goods is accepted by the Company ("the Customer") shall be governed exclusively by these terms and conditions of sale. No variation or addition to these conditions shall be binding unless agreed in writing by the authorised representatives of the Company.

ORDERS AND SPECIFICATIONS

The Customer shall make the orders to the Company either by fax or email, as previously agreed. It will be responsibility of the Customer to ensure that the specifications put in the order correctly reflects their requirements.

A quotation by the Company does not constitute an offer and the Company reserves the right to withdraw or amend the same at any time prior to the Company's acceptance of the Customer order.

The quality, quantity and specification of the goods shall be those set out in the order form, subject always to the following: a) All natural materials supplied such as marble, stone and granite are subject to their natural markings, veinings, variations in colour, cracks and vents. These are supplied clamped, stopped or reinforced where necessary and no claim on this account can be made. b) When samples of natural stone have been submitted, identical resemblance of the product supplied to the sample cannot be guaranteed. c) Any descriptions of material offered are for guidance only and do not imply suitability for any particular purpose. d) All thicknesses quoted are nominal and no liability is accepted for reasonable variations of whatsoever nature.

Any alterations the Customer makes after templates have been made may be subject to an extra charge.

PRICE

Excepting any other particular conditions agreed in writing with the Customer, the price of sale given by the Company will be the price which appears in the catalogue and the tariffs established of the price list in force at the moment of the order. The Company reserves the right to revise prices and details periodically.

Without limiting any of the foregoing, the definitive price of the goods is the price stated in the Company's order acknowledgement. Unless otherwise stated all prices are given exclusive of VAT which will be chargeable at the rate applicable at the time of delivery.

PAYMENT CONDITIONS

With exception of those particular conditions stipulated in writing with the Customer, Customers shall pay the goods provided by 30 days after to the invoice date.

In case of default of payment (either in total or in part) by the Customer, the Company shall have the right to cancel any outstanding order with the Client without prejudice of the possible damages and interests to be claim.

The Company reserves the right to charge interest at the legal rate in force per month on unpaid balances (whether before or after any judgment).

DELIVERY OF GOODS

Delivery of goods shall be upon physical delivery by the Company or collection by the Customer or authorised agent from the Company. Any dates quoted for delivery of the goods are approximate only and the Company shall not be liable for any delay in delivery of goods howsoever caused. The Company will endeavour to fulfil its agreed commitments to its Customers, however due to the vagaries of the availability of materials used the Company can only offer an expected time. Time for delivery shall not be of the essence of the contract unless expressly agreed by the Company in writing.

The Company shall not accept any return once the Customer has signed the POD without prejudice of those situations regulated in other provisions of these general conditions.

Notwithstanding any other provision of these conditions, the property in the goods shall not pass to the Customer until The Company has received full payment for the goods. Until such time, as the property in the goods passes to the Customer (and provided the goods are still in existence and have not been re-sold), the Company shall be entitled at any time to require the Customer to deliver up the goods to the Company, and if the Customer fails to do so forthwith, to enter upon any premises of the Customer or any third party where the goods are stored and repossess the goods. If the Customer shall have resold

the goods, the proceeds of such sale shall be held by the Customer as trustee for and to the account of the Company.

WARRANTIES AND LIABILITY

The Company warrants that the goods will correspond with their description at the time of delivery. The Company shall not be liable for failure to deliver the goods if the failure is due to reasons beyond the Company's reasonable control.

Risk of damage to or loss of the goods shall pass to the Customer at the time of delivery or if the Customer wrongly fails to take delivery of the goods, the time when the Company has tendered delivery of the goods. The Company shall be under no liability in respect of any defect in the goods arising from any sample drawing, design, specification or template supplied by or on behalf of the Customer.

The Company shall be under no liability in respect of any defect arising from wear and tear, wilful damage, negligence, abnormal working conditions, failure to follow the Company's instructions (whether oral or in writing), misuse or alteration or repair of the goods without the Company's approval.

Subject as expressly provided in the conditions, and except where the goods are sold to a person dealing as a Customer (within the meaning of the Unfair Contract Terms Act 1977) all warranties, conditions or other terms implied by statute or company law are excluded to the fullest extent permitted by law.

Where the goods are sold under a Consumer Transactions (Restrictions on Statements) Order 1976 the statutory rights of the Customer are not affected by these conditions.

Any claim by the Customer which is based on any defect on the quality or condition of the goods or their failure to correspond with their description shall (whether or not delivery is refused by the Customer) be notified to the Company within three days from the date of delivery and, in any event, prior to the fabrication of the final product. If delivery is not refused, and the Customer does not notify the Company accordingly, the Customer shall be entitled to reject the goods and the Company shall have no liability for such defect or failure, and the Customer shall be bound to pay the price as if the goods had been delivered in accordance with the contract.

Where the Customer deals as a consumer, the provisions of s35 of the Sale of Goods Act 1979 (as amended) shall replace the provisions referred to in clause above. Where any valid claim in respect of the goods which is based on any defect in the quality or condition of the goods or their failure to match their description is notified the Company in accordance with these conditions, the Company shall be entitled to replace the goods (or the part in question) free of charge or, at the discretion of the Company, refund to the Customer the price of the goods (or a proportionate amount of the price) but the Company shall have no further liability to the Customer.

Except in respect of death or personal injury caused by the Company's negligence, the Company shall not be liable to the Customer by reason of any representation (unless fraudulent) or any implied warranty condition or any other term or any duty at common law, or under the express terms of contract, for any indirect special or consequential loss or damage (whether for loss of profit or otherwise) cost expenses or other claims for compensation whatsoever (whether caused by the negligence of the Company, its employees or agent otherwise) which arise out of or in connection with the supply of the goods, their installation by the Company, their use, and the entire liability of the Company under or in connection with the contract shall not exceed the price of the goods, except as expressly provided in these conditions. In no event shall the Company be liable to the Customer for any incidental or consequential loss, damage or injury.

The Company reserves the right to change these terms and conditions from time to time and when they affect current Customer orders the Company will advise the Customer accordingly in sufficient time to allow the Customer to amend or terminate the contract by written notice.

SAFEGUARD CLAUSE

If any provision of these terms and conditions is held by any competent authority to be invalid or unenforceable in whole or in part the validity of the other provisions of these conditions and the remainder of the provision in question shall not be affected.

APPLICABLE LAW AND JURISDICTION

The contract shall be governed by the laws of England and the Customer agrees to submit to the non exclusive jurisdiction of the English courts.



Certifications



A product designed by **Cosentino®**

COSENTINO UK - CENTRAL OFFICES
Unit 10 Bartley Point, Osborn Way, Hook, Hampshire RG27 9GX
Tel: 01256 761229 Email: info.uk@cosentino.com