

Price List 2015



connection
space that works

Space
that
works

Welcome to our new world.

As the world of work evolves, so do we. We are Connection. We don't just make furniture, we create products and solutions that make space work.

Our growing success is built on close partnerships and the pillars of innovation, quality, value, service and integrity. In today's fiercely competitive global commercial interiors market, sometimes that just isn't enough. Increasingly the competitive differentiator influencing the decisions clients make is a strong brand.

We've spent a year working with best in class advisors, analysing what we're all about and seeing the wood for the trees. The results are compelling. In short, it's all about agility. Agility to respond and, most compellingly, our focus on the global shift towards agile work.

Our support materials are focused on supporting agile work. Resources from knowledge papers to Revit families are hosted on our new web site along with inspiration for anyone seeking to transform their space into a strategic asset.

Connection's new brand is about celebrating our core values. It's a new look and feel that reflects what we're all about - helping designers, dealers and end users to create effective space for productive people.

www.connection.uk.com

Contents

Introduction

Welcome to our new world	5
Sustainability & the Environment	12

Interior Architecture

Hive	15
Steps	42
Cubbi	43
Tryst	47

Soft Seating

Austen	61
Block	63
Bubble	64
Bud	65
Check	67
Columbus	68
Crown	69
Cubix	70
Dixi	70
Gloss	71
Halo	72
Hexel	75
Horizion	76
Kala	80
Korus	82
Mae	84
Smith	85
Mortimer	86
Orbis	89
Ortega	90
Swoosh	91
Zeus	95
Vision	96

Task and Meeting

Is	99
Is Exec.	105
My	106
One	112
Stanley	113
Why	114
Xpresso.one	115
Xpresso.three	117
Team	118

Café

Cookie	121
Drop	122
Emma	123
Frost	125
Ice	126
Mocha	127
Picapau	127
Retro	128
Vent	130
Xpresso.one	131
Xpresso.three	132
Zed	133
Zest	134
Arkura	136
Bobo	136
Callita	136

Tables

Austen	139
Bobbin	140
Check	141
Emma	141
Equity	142
Kala	142
Gloss	143
Mortimer	145
Ortega	147
Retro	147
Swoosh	148
Ten	152
Zeus	153

General information

The Designers	155
Ordering Guidelines	156
Delivery	157
Guarantee	158
Export Information	159
Fabric Options	160





Collaborate

A space for sharing

The collective intelligence of groups consistently out-performs individual intelligence because of access to a diversity of experience and skills. Sharing knowledge and information fuels innovation; getting to ideas faster, building momentum and staying competitive.



Focus

Cutting out the distractions

Productivity can be seriously affected by a rise in interruptions and disturbances. Appropriate acoustics are critical to maintain your position 'in the zone', but so too are the dimensions of territorial privacy and visual privacy.





Learn

A learning experience

Some knowledge, 'explicit' knowledge, is transferred in formal settings. However, it is 'tacit' knowledge that we all possess - the product of our experience - that's really powerful and workplace design has a major role in how effectively it is deployed.



Socialise

Inspiration through interaction

A lot is demanded of knowledge workers nowadays but we all know that non-stop work is counterproductive. People get inspired by talking with others and that's how the social networks that bind teams together and spark innovation are built.



Welcome to our January 2015 Price List.

Resources and information

Please visit our website, www.connection.uk.com for our latest news and information, also to download many useful resources, including:

- PDF brochures and price lists
- Product imagery (high and low resolution)
- Fabric matrix
- 2D and 3D CAD, Revit and pCon files
- Operating instructions
- Product test certificates
- Information in French and German
- Case studies

Visit us

We have two permanent UK showrooms displaying our products and a number of regional 'pop up' spaces to bring Connection to the people.

To arrange a visit to our London Showroom in the heart of Clerkenwell, please ring **0207 253 9877**.

To visit our Huddersfield showroom, please ring **01484 600 100** for an appointment.

Look out for our exciting new products together with updates and additions to our more familiar ranges.

Sustainability & the Environment

In all our core business operations, our aim is to ensure we act ethically and responsibly by adopting best practice within our Corporate Social Responsibility (CSR) Policy and this is embedded into all our practices to the benefit of all our stakeholders.

We consider these stakeholders to be our employees, shareholders, customers, suppliers and the communities within which we operate.

We are committed to the following core values:

- To address the needs and aspirations of our employees, whilst considering their health, safety and promoting a good work/life balance
- To minimise the environmental impact of our operations and enhance the sustainability of our products
- To adopt a good relations strategy with our customers and strive to achieve agreed standards of safety and quality
- To ensure we are honest and fair in all our dealings with our suppliers and aim to procure all our goods and services in an ethical manner
- To support our communities by being sensitive to their needs, responsible in our operations and through the adoption of charitable causes.

Our complete CSR Policy is available to download as a PDF from our website. It incorporates information about the following policies and related standards and accreditations:

- Environment
- Employees
- Customers
- Suppliers
- Communities
- Health & Safety

You can download the CSR document by going to www.connection.uk.com/environment/

Product information

We consider the impact upon the environment throughout all of our processes, from the initial design of the product, through its manufacture and delivery, right up to disposal when it has reached the end of its useful life. We calculate and hold data on all our products, detailing use of recycled content and recyclability. This information is compliant with the SKA rating criteria.

For further information, including environmental data for specific products, please contact us.

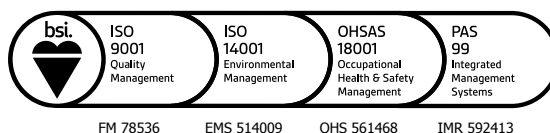



Interior Architecture



Hive

Hive Components

Design by Roger Webb Associates

Understanding the components

When ordering your Hive layout, please supply drawings of your configuration and use the part descriptions as below. You only need to specify the colour/finish of the spacers and legs. Connection will calculate the quantity and sizes needed for your layout.

- 1. Internal Bench
- 2. Pyramid Back
- 3. Workrail
- 4. Screen
- 5. Foot
- 6. External Bench

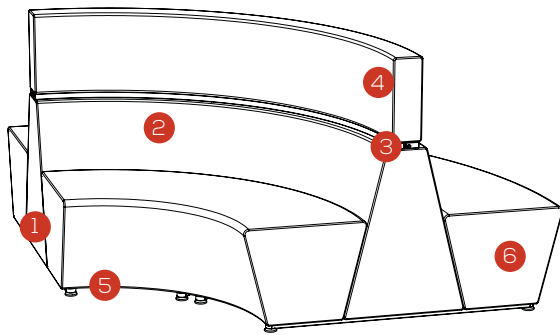

- 1. Bench
- 2. Flat Back

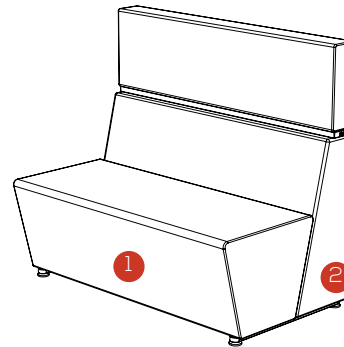

- 1. Bench
- 2. Single Sided Back
- 3. Workrail
- 4. Leg

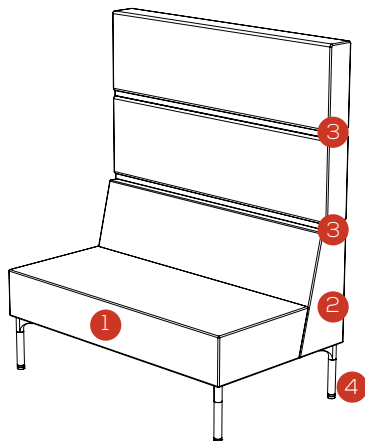

- 1. Internal Bench
- 2. Double Sided Back
- 3. External Bench
- 4. Leg

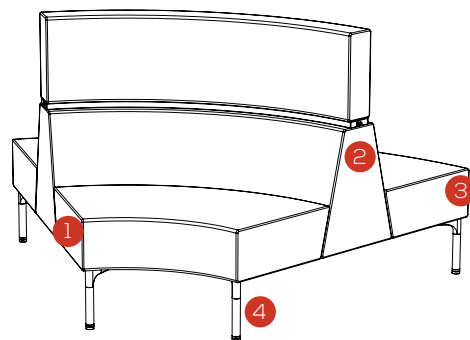

Choosing your fabric for Hive and Cubbi

To ensure optimum quality of your finished product, see the list of our recommended fabrics below.

When we receive your order we will check with our suppliers that the chosen fabric is in stock, then advise you of a suitable delivery time.

Please note: Not all of our standard fabrics, vinyls and leather are suitable for all of our products.

Quality and colour finishes on fabric are as per the fabric supplier's standards, therefore any issues relating to this fall outside of Connection's warranty and quality measurements.

Where a customer is supplying their own fabric, and the fabric does not appear in the above list, the following shall apply:

- £150 patterning charge to cover creating templates.
- A quantity of fabric must be supplied to Connection to facilitate creating new templates - 5m per soft seating product, 2m per task/meeting product. For larger sofas a greater quantity may be required. This fabric will be used in the templating/design process.
- Once the fabric is approved, the order will be processed on standard lead time (starting from the date of approval).
- In the event that the fabric is deemed unsuitable for the requested product, the patterning charge will be refunded.

Group 3	
Supplier	Range
Abbotsford	Feast
Camira	Blazer
Camira	Halcyon
Camira	High-Tech
Camira	Intervene
Camira	Marvel
Camira	24/7+
Connection	Syntec V
Gabriel	Europost
Gabriel	Gaja
Moon	Earth
Moon	Spectrum
Spectrum	Colour Palette Vinyl V
Vescom	Furka Plus V

Group 4	
Supplier	Range
Camira	Blazer Check
Camira	Monroe
Camira	Timeline
Vescom	Keri V
Vescom	Cyprus V
Vescom	Leone Plus V
Vescom	Malta V
Vescom	Dodan V
Vescom	Sanak V
Vescom	Brant V
Vescom	Samar

Group 5	
Supplier	Range
Camira	Adrenaline
Camira	Monochrome Stripe Plus
Camira	Pinstripe Plus
Camira	Smarty Plus
Camira	Sting Plus
Camira	Stripes 2 Plus
Chieftain	Multi Stretch V
Gabriel	Code
Kvadrat	Messenger V
Kvadrat	Scuba V
Yarwood Synthetic	Batani V
Yarwood Synthetic	Natur V
Vescom	Ambu
Vescom	Lindau
Vescom	Hestan
Vescom	Ponza

Group 6	
Supplier	Range
Bute	Elgin
Bute	Kames
Bute	Tiree
Bute	Troon
Bute	Turnberry
Gabriel	Arlanda
Gabriel	Blake
Gabriel	Comfort 8580
Gabriel	Luna
Kvadrat	Divina 3
Kvadrat	Divina Melange 2
Kvadrat	Flora 2
Kvadrat	Hallingdal 65
Kvadrat	Steelcut
Kvadrat	Willow
Vescom	Yuma
Vescom	Bowen
Vescom	Lani
Vescom	Keros

V indicates vinyl



Workrail

Workrails are available in a choice of white or natura.

Legs/feet

Feet on the standard modules are black. Hive with legs is available with natura painted mild steel legs, with black feet, or white painted mild steel legs.

Work surface

Work surfaces are available in a choice of white, oak or walnut MFC finish. Columns and bases are available with a natura or white finish.



Hive

Hive Power

Design by Roger Webb Associates

Integrated power and/or data

Power sockets and data ports can be easily integrated into your configuration in a variety of positions and specifications. To find out more and to discuss your specific requirements, please contact us.

Hive power pricing matrix

All power units supplied are from the AH Meyer MEB 3 range
Fused to 3.15A as standard

Type	Description	RRP
A	3 UK fused power sockets	£139
B	2 UK fused power sockets with neon switches	£162
C	2 UK fused power sockets with 2 CAT6 unshielded data sockets	£394
D	2 UK fused power sockets with dual USB charger	£423
E	1 UK fused power socket 1 CAT6 unshielded data and 1 dual USB charger	£329
F	1 UK fused power socket 1 dual USB charger and 1 HDMI	£839

*Other units available POA



Design by Roger Webb Associates

Hive Power

Power module positions

When ordering power and or data for you Hive configuration, please see the diagram below which details the positions at which this can be placed on the individual unit. Each number relates to a position on the unit where it can be applied, there is no limit on the number of positions that can be taken in one unit.

Hive power module positions

Number	Position
1	Inner Bench Left
2	Inner Bench Centre
3	Inner Bench Right
4	Outer Bench Left
5	Outer Bench Centre
6	Outer Bench Right
7	Centre Inner First Screen
8	Centre Outer First Screen
9	Centre Inner Second Screen
10	Centre Outer Second Screen
11	Centre Inner Third Screen
12	Centre Outer Third Screen

Hive integrated work surface power module positions

Number	Position
13	Fan table front of support arm
14	Rotating table front of support arm
15	POD work surface front of support arm
16	Booth work surface centre of top

Hive integrated work surface power module positions

Number	Position
17	Centre of table

The numbering of the diagram is based from looking at the unit from the front facing internal side. The numbers with dotted lines indicate positions that are not visible from the front internal side. The diagram shows a curved section with both internal and external benches, three screens high. The same numbering system can be used on any Hive configuration.

When ordering power options on Hive, please use the numbering system to describe the fitted position of your chosen power modules.

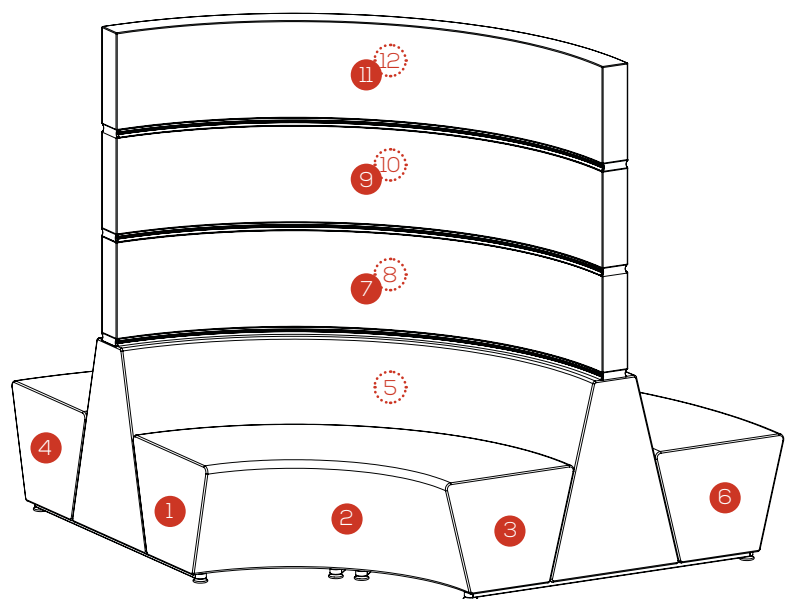

Hive

Example Configurations

Design by Roger Webb Associates

90° POD



Modules

3 x SHF9G, 1 x THV12

Group 3 £12,386

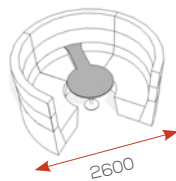

Curved U-Shape with freestanding media screen



Modules

3 x SHVIN, 2 x SHV3V,
1 x SHVIP, 1 x THV10

Group 3 £24,112

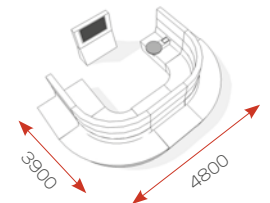

Squared U-Shape with integral media screen



Modules

2 x SHF2G, 2 x SHF4G,
1 x SHF2J, 1 x THV3

Group 3 £14,130

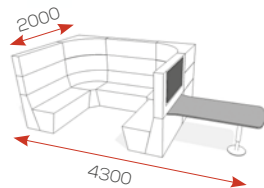

Booth with integral table



Modules

1 x SHVIN, 1 x SHF2G,
1 x THV14

Group 3 £5,988

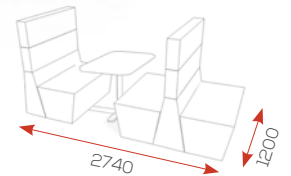

H-Shape



Modules

4 x SHF2E, 2 x SHF6M,
2 x SHV1L

Group 3 £16,714

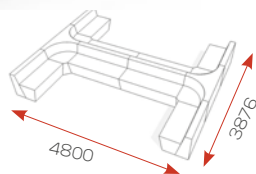

Stepped L-Shape

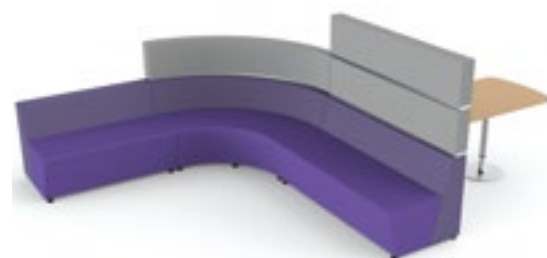

Modules

1 x SHF1E, 1 x SHF2G,
1 x SHF9F, 1 x THV3

Group 3 £7,652

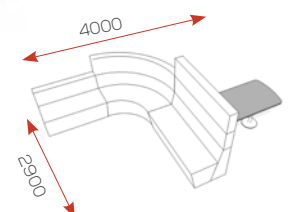

Design by Roger Webb Associates

Example Configurations

90° POD with canopy



Modules
1 x SHVY2, 1 x THV12
Group 3 £20,413

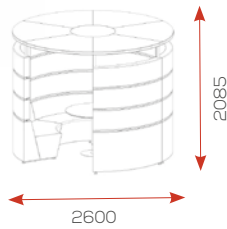

90° POD with workshelf



Modules
3 x SHF9G, 3 X THW6
1 x THV12
Group 3 £14,870

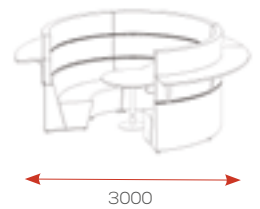

Auditorium unit



Modules
(With media unit)
3 x SHM10, 1 x SHV1P
1 x THV16
Group 3 £11,850

(Without media unit)
3 x SHM10
Group 3 £9,312

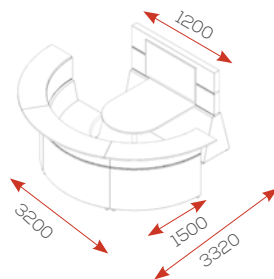

U Shape with integrated worksurfaces



Modules
2 x SHF3G, 1 x SHF2G,
2 x SHF4G, 2 x THV9,
1 x THV3, 1 x THW9
Group 3 £17,734

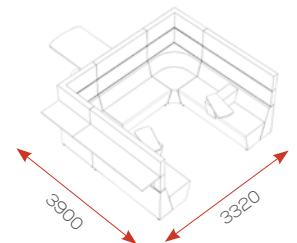

All the above configurations are priced without power, please contact us for prices and specifications.
* Please note dimensions are approximate.



Hive

Straight Modules

Design by Roger Webb Associates

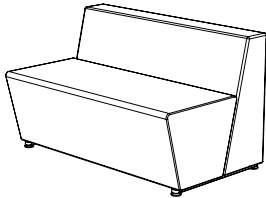

Product Code: SHF1E
Description: 800 Back, Bench

	£	€
Group 3	1,254	1,581
Group 4	1,293	1,630
Group 5	1,370	1,727
Group 6	1,701	2,144

Dimensions

Height	713mm
Width	800mm
Depth	720mm

Product Code: SHF2E
Description: 1200 Back, Bench

	£	€
Group 3	1,589	2,003
Group 4	1,646	2,074
Group 5	1,762	2,221
Group 6	2,253	2,839

Dimensions

Height	713mm
Width	1200mm
Depth	720mm

Product Code: SHF3E
Description: 1600 Back, Bench

	£	€
Group 3	1,991	2,509
Group 4	2,067	2,605
Group 5	2,221	2,799
Group 6	2,872	3,619

Dimensions

Height	713mm
Width	1600mm
Depth	720mm

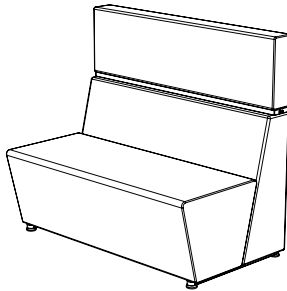

Product Code: SHF1F
Description: 800 Back, Bench, 1 Screen

	£	€
Group 3	1,640	2,067
Group 4	1,689	2,129
Group 5	1,788	2,253
Group 6	2,208	2,783

Dimensions

Height	1078mm
Width	800mm
Depth	720mm

Product Code: SHF2F
Description: 1200 Back, Bench, 1 Screen

	£	€
Group 3	1,999	2,519
Group 4	2,073	2,612
Group 5	2,220	2,798
Group 6	2,846	3,586

Dimensions

Height	1078mm
Width	1200mm
Depth	720mm

Product Code: SHF3F
Description: 1600 Back, Bench, 1 Screen

	£	€
Group 3	2,522	3,178
Group 4	2,620	3,302
Group 5	2,815	3,547
Group 6	3,645	4,593

Dimensions

Height	1078mm
Width	1600mm
Depth	720mm

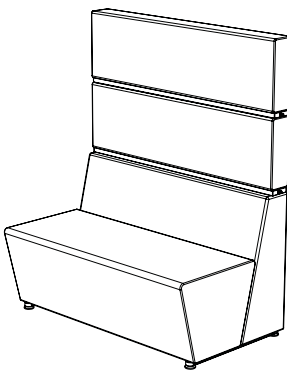

Product Code: SHF1G
Description: 800 Back, Bench, 2 Screens

	£	€
Group 3	2,027	2,555
Group 4	2,086	2,629
Group 5	2,206	2,780
Group 6	2,715	3,421

Dimensions

Height	1443mm
Width	800mm
Depth	720mm

Product Code: SHF2G
Description: 1200 Back, Bench, 2 Screens

	£	€
Group 3	2,410	3,037
Group 4	2,499	3,149
Group 5	2,678	3,375
Group 6	3,438	4,332

Dimensions

Height	1443mm
Width	1200mm
Depth	720mm

Product Code: SHF3G
Description: 1600 Back, Bench, 2 Screens

	£	€
Group 3	3,053	3,847
Group 4	3,172	3,997
Group 5	3,409	4,296
Group 6	4,417	5,566

Dimensions

Height	1443mm
Width	1600mm
Depth	720mm

Design by Roger Webb Associates

Straight Modules

Product Code: SHV5L
Description: 800 Back, 2 Benches

	£	€
Group 3	1,646	2,074
Group 4	1,700	2,142
Group 5	1,808	2,279
Group 6	2,268	2,858

Dimensions

Height	713mm
Width	800mm
Depth	1316mm

Product Code: SHV1L
Description: 1200 Back, 2 Benches

	£	€
Group 3	2,182	2,750
Group 4	2,262	2,851
Group 5	2,422	3,052
Group 6	3,103	3,910

Dimensions

Height	713mm
Width	1200mm
Depth	1316mm

Product Code: SHV6L
Description: 1600 Back, 2 Benches

	£	€
Group 3	2,700	3,402
Group 4	2,806	3,536
Group 5	3,018	3,803
Group 6	3,918	4,937

Dimensions

Height	713mm
Width	1600mm
Depth	1316mm

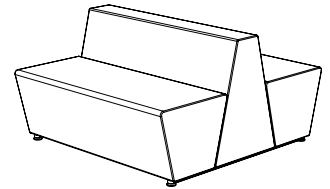

Product Code: SHV5M
Description: 800 Back, 2 Benches, 1 Screen

	£	€
Group 3	2,014	2,538
Group 4	2,078	2,619
Group 5	2,206	2,780
Group 6	2,751	3,467

Dimensions

Height	1078mm
Width	800mm
Depth	1316mm

Product Code: SHV1M
Description: 1200 Back, 2 Benches, 1 Screen

	£	€
Group 3	2,573	3,242
Group 4	2,668	3,362
Group 5	2,858	3,602
Group 6	3,667	4,621

Dimensions

Height	1078mm
Width	1200mm
Depth	1316mm

Product Code: SHV6M
Description: 1600 Back, 2 Benches, 1 Screen

	£	€
Group 3	3,206	4,040
Group 4	3,332	4,199
Group 5	3,584	4,516
Group 6	4,654	5,865

Dimensions

Height	1078mm
Width	1600mm
Depth	1316mm

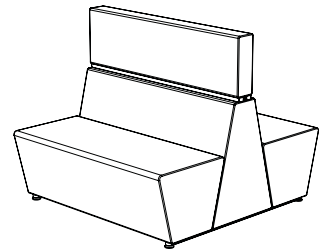

Product Code: SHV5N
Description: 800 Back, 2 Benches, 2 Screens

	£	€
Group 3	2,382	3,002
Group 4	2,456	3,095
Group 5	2,604	3,282
Group 6	3,234	4,075

Dimensions

Height	1443mm
Width	800mm
Depth	1316mm

Product Code: SHV1N
Description: 1200 Back, 2 Benches, 2 Screens

	£	€
Group 3	2,964	3,735
Group 4	3,074	3,874
Group 5	3,294	4,151
Group 6	4,231	5,332

Dimensions

Height	1443mm
Width	1200mm
Depth	1316mm

Product Code: SHV6N
Description: 1600 Back, 2 Benches, 2 Screens

	£	€
Group 3	3,712	4,678
Group 4	3,858	4,862
Group 5	4,150	5,229
Group 6	5,390	6,792

Dimensions

Height	1443mm
Width	1600mm
Depth	1316mm

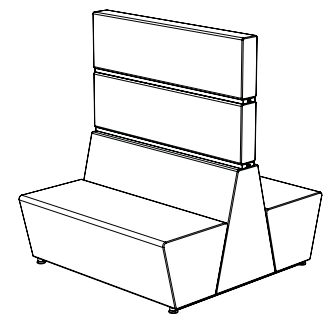

Hive

Curved Modules, Internal Bench

Design by Roger Webb Associates

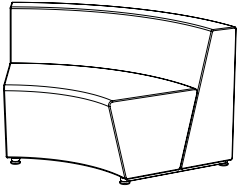

Product Code: SHF10E
Description: 60° Back, Internal Bench

	£	€
Group 3	2,037	2,567
Group 4	2,097	2,643
Group 5	2,217	2,794
Group 6	2,727	3,437

Dimensions

Height	713mm
Width	1200mm
Depth	720mm

Product Code: SHF9E
Description: 90° Back, Internal Bench

	£	€
Group 3	2,453	3,091
Group 4	2,533	3,192
Group 5	2,693	3,394
Group 6	3,373	4,250

Dimensions

Height	713mm
Width	1850mm
Depth	720mm

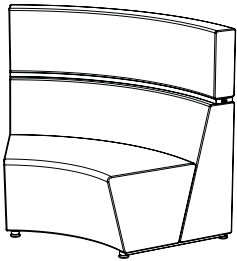

Product Code: SHF10F
Description: 60° Back, Internal Bench, 1 Screen

	£	€
Group 3	2,773	3,494
Group 4	2,873	3,620
Group 5	3,073	3,872
Group 6	3,923	4,943

Dimensions

Height	1078mm
Width	1200mm
Depth	720mm

Product Code: SHF9F
Description: 90° Back, Internal Bench, 1 Screen

	£	€
Group 3	3,209	4,044
Group 4	3,320	4,184
Group 5	3,542	4,463
Group 6	4,486	5,653

Dimensions

Height	1433mm
Width	1850mm
Depth	720mm

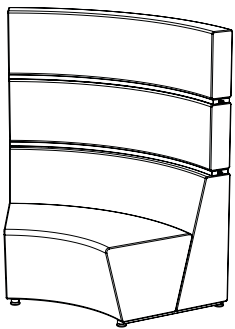

Product Code: SHF10G
Description: 60° Back, Internal Bench, 2 Screens

	£	€
Group 3	3,174	4,000
Group 4	3,274	4,126
Group 5	3,474	4,378
Group 6	4,324	5,449

Dimensions

Height	1443mm
Width	1200mm
Depth	720mm

Product Code: SHF9G
Description: 90° Back, Internal Bench, 2 Screens

	£	€
Group 3	3,711	4,676
Group 4	3,822	4,816
Group 5	4,044	5,096
Group 6	4,988	6,285

Dimensions

Height	1443mm
Width	1850mm
Depth	720mm

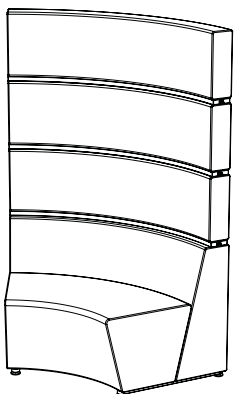

Product Code: SHF10H
Description: 60° Back, Internal Bench, 3 Screens

	£	€
Group 3	3,890	4,902
Group 4	4,030	5,078
Group 5	4,310	5,431
Group 6	5,500	6,930

Dimensions

Height	1808mm
Width	1200mm
Depth	720mm

Product Code: SHF9H
Description: 90° Back, Internal Bench, 3 Screens

	£	€
Group 3	4,498	5,668
Group 4	4,640	5,847
Group 5	4,924	6,205
Group 6	6,131	7,726

Dimensions

Height	1808mm
Width	1850mm
Depth	720mm

Design by Roger Webb Associates

Curved Modules, External Bench

Product Code: SHV2G
Description: 60° Back, External Bench

	£	€
Group 3	2,182	2,750
Group 4	2,272	2,863
Group 5	2,452	3,090
Group 6	3,217	4,054

Dimensions

Height	713mm
Width	1904mm
Depth	910mm

Product Code: SHV3G*
Description: 90° Back, External Bench

	£	€
Group 3	2,731	3,442
Group 4	2,821	3,555
Group 5	3,001	3,782
Group 6	3,765	4,744

Dimensions

Height	713mm
Width	2692mm
Depth	910mm

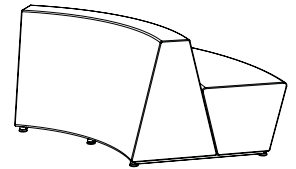

Product Code: SHV2I
Description: 60° Back, External Bench, 1 Screen

	£	€
Group 3	2,636	3,322
Group 4	2,741	3,454
Group 5	2,951	3,719
Group 6	3,844	4,844

Dimensions

Height	1078mm
Width	1904mm
Depth	910mm

Product Code: SHV3I*
Description: 90° Back, External Bench, 1 Screen

	£	€
Group 3	3,312	4,174
Group 4	3,427	4,319
Group 5	3,657	4,608
Group 6	4,633	5,838

Dimensions

Height	1078mm
Width	2692mm
Depth	910mm

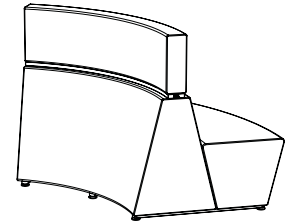

Product Code: SHV2K
Description: 60° Back, External Bench, 2 Screens

	£	€
Group 3	3,090	3,894
Group 4	3,210	4,045
Group 5	3,450	4,347
Group 6	4,471	5,634

Dimensions

Height	1443mm
Width	1904mm
Depth	910mm

Product Code: SHV3K*
Description: 90° Back, External Bench, 2 Screens

	£	€
Group 3	3,893	4,906
Group 4	4,033	5,082
Group 5	4,313	5,435
Group 6	5,501	6,932

Dimensions

Height	1443mm
Width	2692mm
Depth	910mm

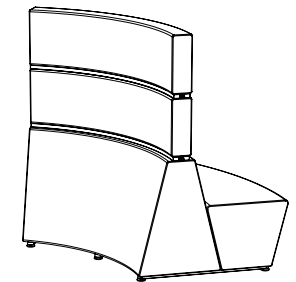

Product Code: SHV2T
Description: 60° Back, External Bench, 3 Screens

	£	€
Group 3	4,808	6,059
Group 4	4,928	6,210
Group 5	5,168	6,512
Group 6	6,188	7,797

Dimensions

Height	1808mm
Width	1904mm
Depth	910mm

Product Code: SHV3T*
Description: 90° Back, External Bench, 3 Screens

	£	€
Group 3	5,272	6,643
Group 4	5,414	6,822
Group 5	5,698	7,180
Group 6	6,905	8,701

Dimensions

Height	1808mm
Width	2692mm
Depth	910mm

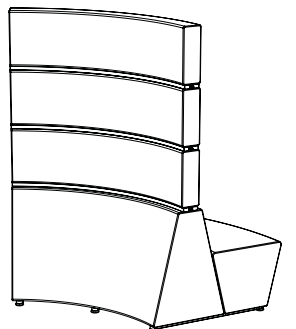

*Please note on all 90° curved modules the external bench is in two pieces.



Hive

Back to Back Curved Modules

Design by Roger Webb Associates

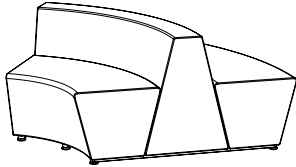

Product Code: SHV2L
Description: 60° Back, 2 Benches

	£	€
Group 3	2,885	3,636
Group 4	2,999	3,779
Group 5	3,227	4,067
Group 6	4,196	5,287

Dimensions

Height	713mm
Width	1904mm
Depth	1316mm

Product Code: SHV3L*
Description: 90° Back, 2 Benches

	£	€
Group 3	3,551	4,475
Group 4	3,671	4,626
Group 5	3,911	4,928
Group 6	4,930	6,212

Dimensions

Height	713mm
Width	2692mm
Depth	1316mm

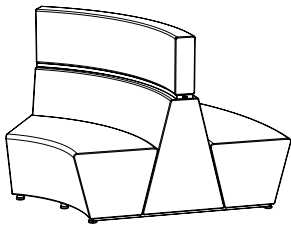

Product Code: SHV2M
Description: 60° Back, 2 Benches, 1 Screen

	£	€
Group 3	3,339	4,208
Group 4	3,468	4,370
Group 5	3,726	4,695
Group 6	4,823	6,077

Dimensions

Height	1078mm
Width	1904mm
Depth	1316mm

Product Code: SHV3M*
Description: 90° Back, 2 Benches, 1 Screen

	£	€
Group 3	4,132	5,207
Group 4	4,277	5,390
Group 5	4,567	5,755
Group 6	5,798	7,306

Dimensions

Height	1078mm
Width	2692mm
Depth	1316mm

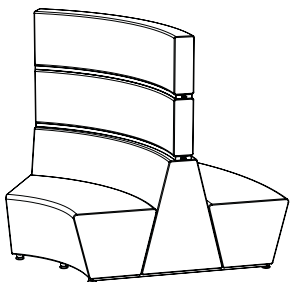

Product Code: SHV2N
Description: 60° Back, 2 Benches, 2 Screens

	£	€
Group 3	3,793	4,780
Group 4	3,937	4,961
Group 5	4,225	5,324
Group 6	5,450	6,867

Dimensions

Height	1443mm
Width	1904mm
Depth	1316mm

Product Code: SHV3N*
Description: 90° Back, 2 Benches, 2 Screens

	£	€
Group 3	4,713	5,939
Group 4	4,883	6,153
Group 5	5,223	6,581
Group 6	6,666	8,400

Dimensions

Height	1443mm
Width	2692mm
Depth	1316mm

Design by Roger Webb Associates

Back to Back Curved Modules

Product Code: SHV2V
Description: 60° Back, 2 Benches, 3 Screens

	£	€
Group 3	5,566	7,014
Group 4	5,706	7,190
Group 5	5,986	7,543
Group 6	7,176	9,042

Dimensions

Height	1808mm
Width	1904mm
Depth	1316mm

Product Code: SHV3V*
Description: 90° Back, 2 Benches, 3 Screens

	£	€
Group 3	6,391	8,053
Group 4	6,576	8,286
Group 5	6,946	8,752
Group 6	8,519	10,734

Dimensions

Height	1808mm
Width	2692mm
Depth	1316mm

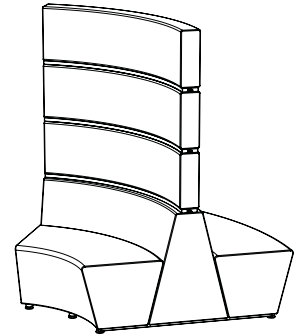

Product Code: SHV8
Description: D End Bench

	£	€
Group 3	986	1,243
Group 4	1,026	1,293
Group 5	1,106	1,394
Group 6	1,446	1,822

Dimensions

Height	433mm
Width	1316mm
Depth	660mm

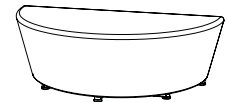

Canopy

Product Code: SHCY2
Description: 90° POD with canopy and 6 LED lights (price includes supporting screens and benches)

	£	€
Group 3	19,160	24,142
Group 4	19,855	25,018
Group 5	21,245	26,769
Group 6	27,153	34,213

Dimensions

Height	2085mm
Diameter	2600mm

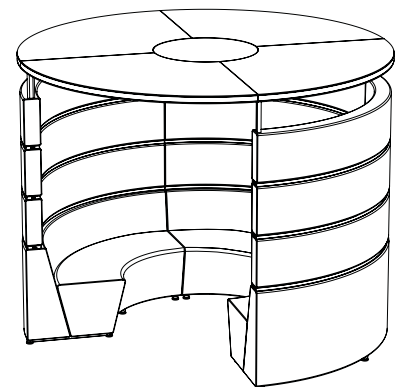

Product information

Support frame, white or natura, matching workrail finish.
 Canopy supplied unassembled, includes all fixings for lights.
 Fabric for the canopy panels to be chosen from the Camira Lucia range.

*Please note on all 90° curved modules the external bench is in two pieces.



Hive

Corner Modules

Design by Roger Webb Associates

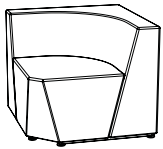

Product Code: SHF4E
Description: Corner Back, Bench

	£	€
Group 3	1,965	2,476
Group 4	2,032	2,561
Group 5	2,166	2,730
Group 6	2,737	3,449

Dimensions

Height	713mm
Width	800mm
Depth	800mm



Product Code: SHF4F
Description: Corner Back, Bench, 1 Corner Screen

	£	€
Group 3	2,441	3,076
Group 4	2,524	3,181
Group 5	2,690	3,390
Group 6	3,396	4,279

Dimensions

Height	1078mm
Width	800mm
Depth	800mm



Product Code: SHF4G
Description: Corner Back, Bench, 2 Corner Screens

	£	€
Group 3	2,918	3,677
Group 4	3,017	3,802
Group 5	3,214	4,050
Group 6	4,054	5,109

Dimensions

Height	1443mm
Width	800mm
Depth	800mm

T Modules

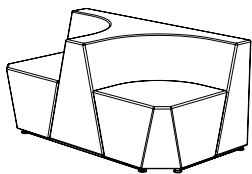

Product Code: SHF6M
Description: T Back, Benches

	£	€
Group 3	2,997	3,777
Group 4	3,163	3,986
Group 5	3,347	4,218
Group 6	4,133	5,208

Dimensions

Height	713mm
Width	1476mm
Depth	800mm



Product Code: SHF6N
Description: T Back, Benches, 1T Screen

	£	€
Group 3	3,809	4,800
Group 4	4,000	5,040
Group 5	4,235	5,337
Group 6	5,235	6,597

Dimensions

Height	1078mm
Width	1476mm
Depth	800mm



Product Code: SHF6O
Description: T Back, Benches, 2 T Screens

	£	€
Group 3	4,621	5,823
Group 4	4,838	6,096
Group 5	5,123	6,455
Group 6	6,337	7,985

Dimensions

Height	1443mm
Width	1476mm
Depth	800mm

Design by Roger Webb Associates

Media Screen Modules

Product Code: SHVIP
Description: 1200 Media Screen

	£	€
Group 3	1,781	2,245
Group 4	1,841	2,320
Group 5	1,961	2,471
Group 6	2,471	3,114

Dimensions

Height	1443mm
Width	1200mm
Depth	500mm



Product Code: SHV6P
Description: 1600 Media Screen

	£	€
Group 3	2,129	2,683
Group 4	2,199	2,771
Group 5	2,339	2,948
Group 6	2,934	3,697

Dimensions

Height	1443mm
Width	1600mm
Depth	500mm



Product options

TV mounting bracket £75

A cantilever work surface can be added to the media screen. Please refer to page 30 for pricing.

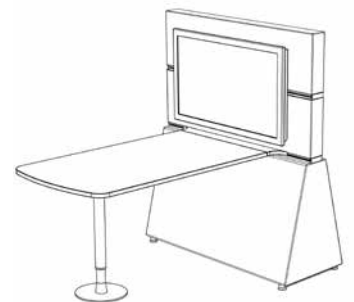

Please note: Media Screen module does not include audio-visual equipment or TV mounting bracket. Locking bar type brackets are unsuitable as when fitted into the Hive module, access to the TV is only possible from the top or bottom.



Hive

Integrated Work Surfaces

Tables

Design by Roger Webb Associates

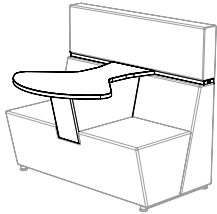

Product Code: THV8
Description: Fan table

	£	€
Group 3	869	1,095
Group 4	879	1,108
Group 5	899	1,133
Group 6	984	1,240

Dimensions

Height	740mm
Width	800mm
Depth	900mm

Power modules are available for each of the work surfaces listed left. For options on power please see page 17. Please contact the Customer Service Team.

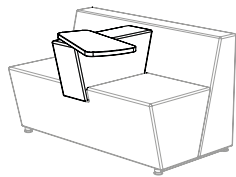

Product Code: THV9
Description: Rotating table

	£	€
Group 3	612	772
Group 4	622	784
Group 5	642	809
Group 6	727	917

Dimensions

Height	740mm
Width	320mm
Depth	570mm

Work Shelves



Product Code: THW1
Description: 800 Straight Unit

	£	€
Group 3	417	526

Product Code: THW2
Description: 1200 Straight Unit

	£	€
Group 3	612	772

Product Code: THW3
Description: 1600 Straight Unit

	£	€
Group 3	577	728



Product Code: THW5
Description: 60 Degree Unit

	£	€
Group 3	607	765

Product Code: THW6
Description: 90 Degree Unit

	£	€
Group 3	828	1,044



Product Code: THW9
Description: Short Corner Unit

	£	€
Group 3	442	557

Design by Roger Webb Associates

Work Surfaces

Product Code: THV3**Description: Cantilever low/high work surface, white or silver column and base (upholstered section not included)**

	£	€
All finishes (table only)	791	997

Dimensions

Height	713mm
Width	750mm
Depth	1500mm

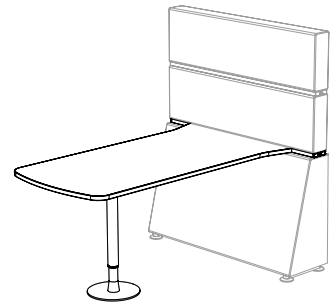
**Product Code: THV11****Description: Cantilever low/high work surface, white or silver column and base (upholstered section not included)**

	£	€
All finishes (table only)	791	997

Dimensions

Height	1073mm
Width	750mm
Depth	1500mm

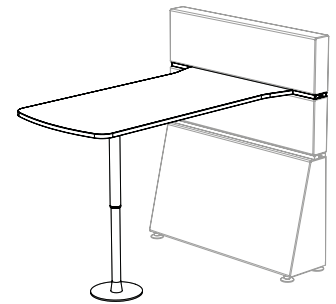
**Product Code: THV12****Description: Pod work surface, white or silver column and base (for 60° or 90° curved modules)**

	£	€
Group 3	1,253	1,579
Group 4	1,263	1,592
Group 5	1,283	1,617
Group 6	1,368	1,724

Dimensions

Height	1073mm
Width	900mm
Depth	1650mm

**Product information**

Work surface top standard finishes, white, oak and walnut, 25mm MFC, for all other finishes please contact Customer Services. Column and base finishes, white or natura. Please note: The position of the integral work surface support is always centred within the bench.

Special options

Reverse chamfered edges POA
Power modules are available for each of the work surfaces listed above
For options on power please see page 17.
Other sizes are available POA.



Hive

Booth Work Surface

Design by Roger Webb Associates

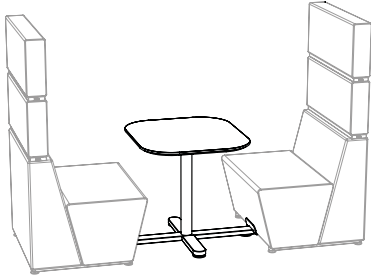

Product Code: THV13
Description: Integrated table for 800 modules, white or natura column and base.

	£	€
All finishes (table only)	624	787

Dimensions

Height	713mm
Width	700mm
Depth	800mm

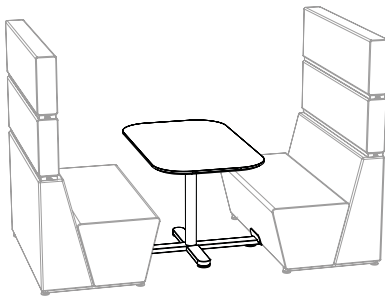

Product Code: THV14
Description: Integrated table for 1200 modules, white or natura column and base.

	£	€
All finishes (table only)	641	808

Dimensions

Height	713mm
Width	700mm
Depth	1200mm

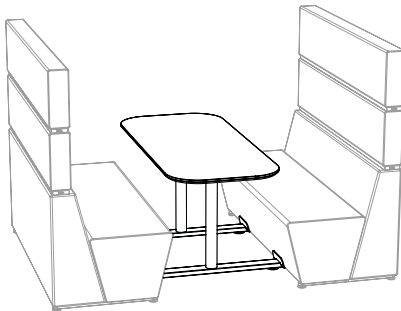

Product Code: THV15
Description: Integrated table for 1600 modules, white or natura column and base.

	£	€
All finishes (table only)	921	1,161

Dimensions

Height	713mm
Width	700mm
Depth	1600mm

Product information

Work surface top standard finishes, white, oak and walnut, 25mm MFC, for all other finishes please contact Customer Services. Column and base finishes, white or natura.

Special options

Table fitted power module available including cable management POA
 For options on power please see page 17
 Reverse chamfered edges POA

Hive with legs

Design by Roger Webb Associates

Example Configurations

C-Shape



Modules

2 X SHL11A

Group 3 £4,138

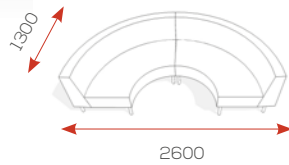

90° POD



Modules

3 X SHL11B, 1 X THL12

Group 3 £9,445

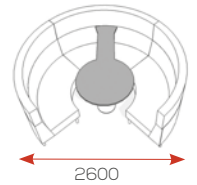

S-Shape



Modules

2 X SHL5A, 2 X SHL14A,

2 X SHL15, 1 X THL9,

2 X THL10

Group 3 £14,813

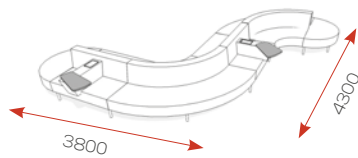

U-Shape



Modules

3 X SHL2C, 2 X SHL11C,

1 X THL9, 1 X THV3

Group 3 £15,378

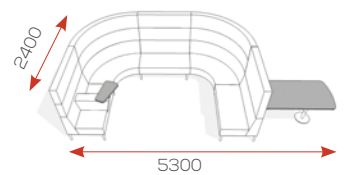

Island Unit



Modules

2 X SHL18, 2 X SHL15

1 X SHL6A

(shown with 1600mm straight unit, available in 800 and 1200mm)

Group 3 £4,328

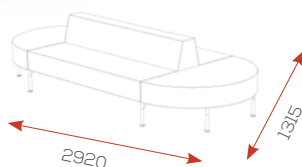

All the above configurations are priced without power, please contact us for prices and specifications. Please note dimensions are approximate.

All configurations are priced with shared leg options. Refer to page 38.



Hive with legs

Straight Modules

Design by Roger Webb Associates

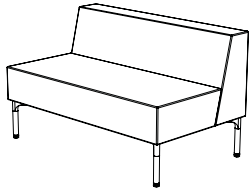

Product Code: SHL1A
Description: 800 Back, Bench

	£	€
Group 3	1,090	1,374
Group 4	1,116	1,407
Group 5	1,166	1,470
Group 6	1,381	1,741

Dimensions

Height	713mm
Width	800mm
Depth	720mm

Product Code: SHL2A
Description: 1200 Back, Bench

	£	€
Group 3	1,435	1,809
Group 4	1,466	1,848
Group 5	1,527	1,925
Group 6	1,789	2,255

Dimensions

Height	713mm
Width	1200mm
Depth	720mm

Product Code: SHL3A
Description: 1600 Back, Bench

	£	€
Group 3	1,554	1,959
Group 4	1,594	2,009
Group 5	1,675	2,111
Group 6	2,016	2,541

Dimensions

Height	713mm
Width	1600mm
Depth	720mm

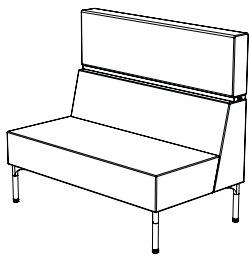

Product Code: SHL1B
Description: 800 Back, Bench, 1 Screen

	£	€
Group 3	1,495	1,884
Group 4	1,531	1,930
Group 5	1,604	2,022
Group 6	1,913	2,411

Dimensions

Height	1078mm
Width	800mm
Depth	720mm

Product Code: SHL2B
Description: 1200 Back, Bench, 1 Screen

	£	€
Group 3	1,865	2,350
Group 4	1,912	2,410
Group 5	2,007	2,529
Group 6	2,409	3,036

Dimensions

Height	1078mm
Width	1200mm
Depth	720mm

Product Code: SHL3B
Description: 1600 Back, Bench, 1 Screen

	£	€
Group 3	2,161	2,723
Group 4	2,223	2,801
Group 5	2,347	2,958
Group 6	2,875	3,623

Dimensions

Height	1078mm
Width	1600mm
Depth	720mm

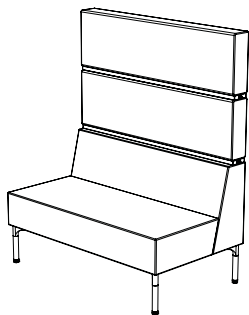

Product Code: SHL1C
Description: 800 Back, Bench, 2 Screens

	£	€
Group 3	2,000	2,520
Group 4	2,047	2,580
Group 5	2,142	2,699
Group 6	2,544	3,206

Dimensions

Height	1443mm
Width	800mm
Depth	720mm

Product Code: SHL2C
Description: 1200 Back, Bench, 2 Screens

	£	€
Group 3	2,295	2,892
Group 4	2,359	2,973
Group 5	2,486	3,133
Group 6	3,030	3,818

Dimensions

Height	1443mm
Width	1200mm
Depth	720mm

Product Code: SHL3C
Description: 1600 Back, Bench, 2 Screens

	£	€
Group 3	2,717	3,424
Group 4	2,802	3,531
Group 5	2,970	3,743
Group 6	3,685	4,644

Dimensions

Height	1443mm
Width	1600mm
Depth	720mm

Hive with legs

Design by Roger Webb Associates

Back to Back Straight Modules

Product Code: SHL4A
Description: 800 Back, 2 Benches

	£	€
Group 3	1,690	2,130
Group 4	1,729	2,179
Group 5	1,807	2,277
Group 6	2,139	2,696

Dimensions

Height	713mm
Width	800mm
Depth	1316mm

Product Code: SHL5A
Description: 1200 Back, 2 Benches

	£	€
Group 3	2,116	2,667
Group 4	2,162	2,725
Group 5	2,253	2,839
Group 6	2,641	3,328

Dimensions

Height	713mm
Width	1200mm
Depth	1316mm

Product Code: SHL6A
Description: 1600 Back, 2 Benches

	£	€
Group 3	2,318	2,921
Group 4	2,378	2,997
Group 5	2,498	3,148
Group 6	3,008	3,791

Dimensions

Height	713mm
Width	1600mm
Depth	1316mm

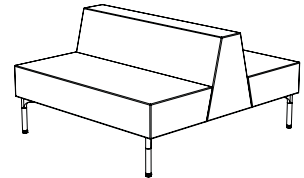

Product Code: SHL4B
Description: 800 Back, 2 Benches, 1 Screen

	£	€
Group 3	2,095	2,640
Group 4	2,145	2,703
Group 5	2,245	2,829
Group 6	2,671	3,366

Dimensions

Height	1078mm
Width	800mm
Depth	1316mm

Product Code: SHL5B
Description: 1200 Back, 2 Benches, 1 Screen

	£	€
Group 3	2,596	3,271
Group 4	2,659	3,351
Group 5	2,783	3,507
Group 6	3,312	4,174

Dimensions

Height	1078mm
Width	1200mm
Depth	1316mm

Product Code: SHL6B
Description: 1600 Back, 2 Benches, 1 Screen

	£	€
Group 3	2,925	3,686
Group 4	3,007	3,789
Group 5	3,171	3,996
Group 6	3,867	4,873

Dimensions

Height	1078mm
Width	1600mm
Depth	1316mm

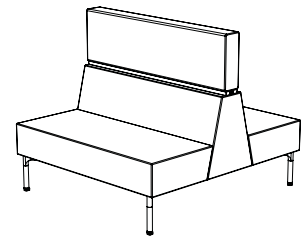

Product Code: SHL4C
Description: 800 Back, 2 Benches, 2 Screens

	£	€
Group 3	2,550	3,213
Group 4	2,611	3,290
Group 5	2,733	3,444
Group 6	3,252	4,098

Dimensions

Height	1443mm
Width	800mm
Depth	1316mm

Product Code: SHL5C
Description: 1200 Back, 2 Benches, 2 Screens

	£	€
Group 3	2,977	3,752
Group 4	3,055	3,850
Group 5	3,212	4,048
Group 6	3,882	4,892

Dimensions

Height	1443mm
Width	1200mm
Depth	1316mm

Product Code: SHL6C
Description: 1600 Back, 2 Benches, 2 Screens

	£	€
Group 3	3,581	4,513
Group 4	3,685	4,644
Group 5	3,893	4,906
Group 6	4,777	6,020

Dimensions

Height	1443mm
Width	1600mm
Depth	1316mm

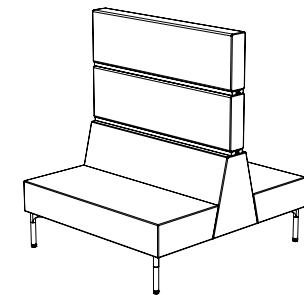

Hive with legs

Curved Modules

Design by Roger Webb Associates

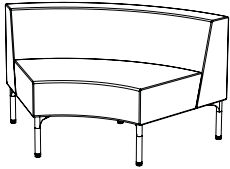

Product Code: SHL10A
Description: 60° Back, Internal Bench

	£	€
Group 3	1,621	2,043
Group 4	1,671	2,106
Group 5	1,771	2,232
Group 6	2,197	2,769

Dimensions

Height	713mm
Width	1305mm
Depth	720mm

Product Code: SHL11A
Description: 90° Back, Internal Bench

	£	€
Group 3	2,001	2,522
Group 4	2,072	2,611
Group 5	2,214	2,790
Group 6	2,817	3,550

Dimensions

Height	713mm
Width	1845mm
Depth	720mm

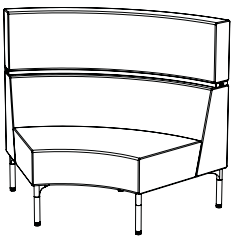

Product Code: SHL10B
Description: 60° Back, Internal Bench, 1 Screen

	£	€
Group 3	2,121	2,673
Group 4	2,187	2,756
Group 5	2,320	2,924
Group 6	2,886	3,637

Dimensions

Height	1078mm
Width	1305mm
Depth	720mm

Product Code: SHL11B
Description: 90° Back, Internal Bench, 1 Screen

	£	€
Group 3	2,640	3,327
Group 4	2,738	3,450
Group 5	2,935	3,699
Group 6	3,772	4,753

Dimensions

Height	1078mm
Width	1845mm
Depth	720mm

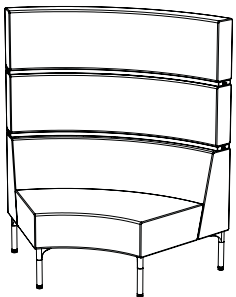

Product Code: SHL10C
Description: 60° Back, Internal Bench, 2 Screens

	£	€
Group 3	2,620	3,302
Group 4	2,703	3,406
Group 5	2,869	3,615
Group 6	3,576	4,506

Dimensions

Height	1443mm
Width	1305mm
Depth	720mm

Product Code: SHL11C
Description: 90° Back, Internal Bench, 2 Screens

	£	€
Group 3	3,279	4,132
Group 4	3,405	4,291
Group 5	3,657	4,608
Group 6	4,726	5,955

Dimensions

Height	1443mm
Width	1845mm
Depth	720mm

Product information
Leg finish, white or natura

Special options
Polished legs POA

Please note: On curved modules, measurements are taken across the widest point.

Hive with legs

Design by Roger Webb Associates

Back to Back Curved Modules

Product Code: SHL13A
Description: 60° Back, 2 Benches

	£	€
Group 3	2,776	3,498
Group 4	2,865	3,610
Group 5	3,042	3,833
Group 6	3,794	4,781

Dimensions

Height	713mm
Width	1904mm
Depth	1316mm

Product Code: SHL14A*
Description: 90° Back, 2 Benches

	£	€
Group 3	3,405	4,291
Group 4	3,521	4,437
Group 5	3,753	4,729
Group 6	4,740	5,973

Dimensions

Height	713mm
Width	2650mm
Depth	1316mm

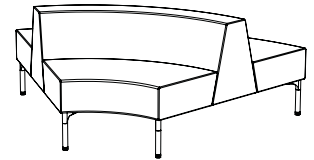

Product Code: SHL13B
Description: 60° Back, 2 Benches, 1 Screen

	£	€
Group 3	3,325	4,190
Group 4	3,431	4,324
Group 5	3,641	4,588
Group 6	4,534	5,713

Dimensions

Height	1078mm
Width	1904mm
Depth	1316mm

Product Code: SHL14B*
Description: 90° Back, 2 Benches, 1 Screen

	£	€
Group 3	4,044	5,096
Group 4	4,188	5,277
Group 5	4,475	5,639
Group 6	5,694	7,175

Dimensions

Height	1078mm
Width	2650mm
Depth	1316mm

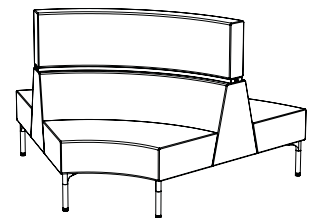

Product Code: SHL13C
Description: 60° Back, 2 Benches, 2 Screens

	£	€
Group 3	3,875	4,883
Group 4	3,996	5,035
Group 5	4,240	5,343
Group 6	5,274	6,646

Dimensions

Height	1443mm
Width	1904mm
Depth	1316mm

Product Code: SHL14C*
Description: 90° Back, 2 Benches, 2 Screens

	£	€
Group 3	4,683	5,901
Group 4	4,854	6,117
Group 5	5,196	6,547
Group 6	6,649	8,378

Dimensions

Height	1443mm
Width	2650mm
Depth	1316mm

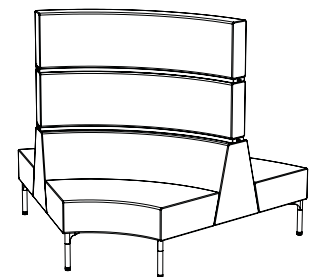

Product information
Support frame, white or natura, matching workrail finish.

Please note: On curved modules, measurements are taken across the widest point.

*Please note on all 90° curved modules the external bench is in two pieces.



Hive with legs

Corner Modules

Design by Roger Webb Associates

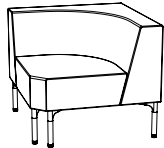

Product Code: SHL7A
Description: Corner Back, Bench

	£	€
Group 3	1,539	1,940
Group 4	1,605	2,023
Group 5	1,737	2,189
Group 6	2,298	2,896

Dimensions

Height	713mm
Width	800mm
Depth	800mm



Product Code: SHL7B
Description: Corner Back, Bench, 1 Corner Screen

	£	€
Group 3	2,099	2,645
Group 4	2,177	2,744
Group 5	2,333	2,940
Group 6	2,996	3,775

Dimensions

Height	1078mm
Width	800mm
Depth	800mm



Product Code: SHL7C
Description: Corner Back, Bench, 2 Corner Screens

	£	€
Group 3	2,659	3,351
Group 4	2,749	3,464
Group 5	2,929	3,691
Group 6	3,694	4,655

Dimensions

Height	1443mm
Width	800mm
Depth	800mm

Standard modules are supplied with 5 legs

T Modules

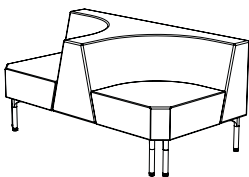

Product Code: SHL8A
Description: T Back, Benches

	£	€
Group 3	2,614	3,294
Group 4	2,735	3,447
Group 5	2,977	3,752
Group 6	4,005	5,047

Dimensions

Height	713mm
Width	1475mm
Depth	800mm



Product Code: SHL8B
Description: T Back, Benches, 1T Screen

	£	€
Group 3	3,415	4,303
Group 4	3,562	4,489
Group 5	3,857	4,860
Group 6	5,110	6,439

Dimensions

Height	1078mm
Width	1475mm
Depth	800mm



Product Code: SHL8C
Description: T Back, Benches, 2 T Screens

	£	€
Group 3	4,266	5,376
Group 4	4,440	5,595
Group 5	4,788	6,033
Group 6	6,265	7,894

Dimensions

Height	1443mm
Width	1475mm
Depth	800mm

Shared leg options are available to reduce the number of visible legs. See page 38

Hive with legs

Design by Roger Webb Associates

Corner Modules

Product Code: SHL15
Description: D End Bench

	£	€
Group 3	841	1,060
Group 4	863	1,088
Group 5	906	1,142
Group 6	1,088	1,371

Dimensions

Height	433mm
Width	1315mm
Depth	660mm

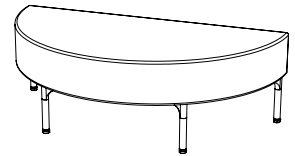

Product Code: SHL16
Description: Quadrant Bench

	£	€
Group 3	721	909
Group 4	741	934
Group 5	781	985
Group 6	951	1,199

Dimensions

Height	433mm
Width	720mm
Depth	720mm

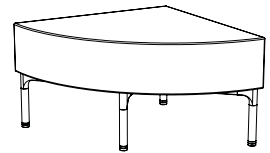

Leg Options

Configurations are supplied with legs specific to the module

To reduce the number of visible legs, when joining modules, there is an option to purchase a shared single /double leg kit as an extra.

Product Code: SHL17
Description: Single sided shared leg*

	£	€
	136	172

Dimensions

Height	433mm
Width	1315mm
Depth	660mm

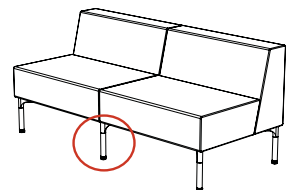

Product Code: SHL18
Description: Back to back module shared leg

	£	€
	164	207

Dimensions

Height	433mm
Width	1315mm
Depth	720mm

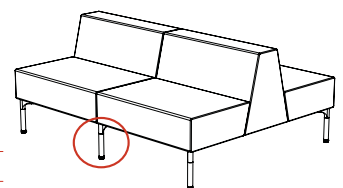

Hive with legs

Integrated Work Surfaces

Tables

Design by Roger Webb Associates

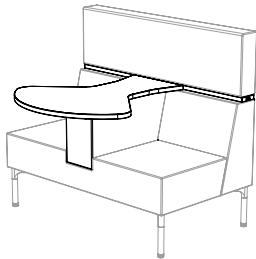

Product Code: THL8
Description: Fan table

	£	€
Group 3	869	1,095
Group 4	879	1,108
Group 5	899	1,133
Group 6	984	1,240

Dimensions

Height	740mm
Width	800mm
Depth	900mm

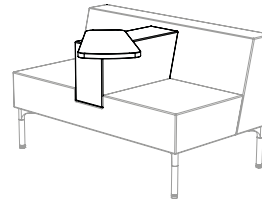

Product Code: THL9
Description: Rotating table

	£	€
Group 3	612	772
Group 4	622	784
Group 5	642	809
Group 6	727	917

Dimensions

Height	740mm
Width	320mm
Depth	570mm

Work Shelves

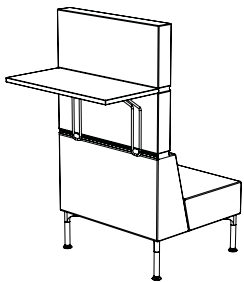

Product Code: THW1
Description: 800 Straight Unit

	£	€
Group 3	417	526

Product Code: THW2
Description: 1200 Straight Unit

	£	€
Group 3	612	772

Product Code: THW3
Description: 1600 Straight Unit

	£	€
Group 3	577	728

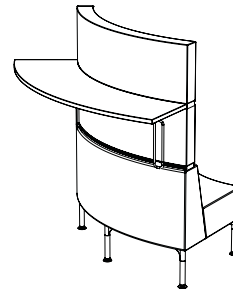

Product Code: THW5
Description: 60 Degree Unit

	£	€
Group 3	607	765

Product Code: THW6
Description: 90 Degree Unit

	£	€
Group 3	828	1,044

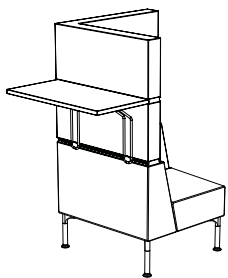

Product Code: THW9
Description: Short Corner Unit

	£	€
Group 3	442	557

Dimensions (all shelves)

Depth	390mm
-------	-------

Hive with legs

Design by Roger Webb Associates

Work Surfaces

Product Code: THV3

Description: Cantilever low/high work surface, white or silver column and base (upholstered section not included)

	£	€
All finishes (table only)	791	997

Dimensions

Height	713mm
Width	750mm
Depth	1500mm

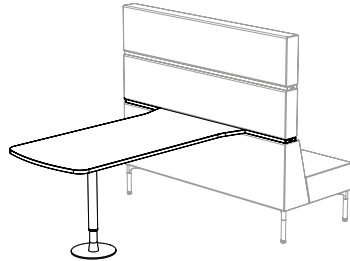

Product Code: THV11

Description: Cantilever low/high work surface, white or silver column and base (upholstered section not included)

	£	€
All finishes (table only)	791	997

Dimensions

Height	1073mm
Width	750mm
Depth	1500mm

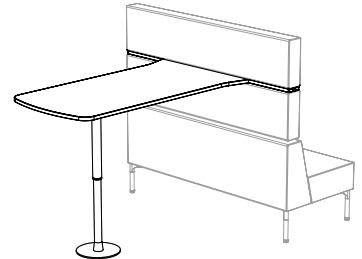

Product Code: THV12

Description: Pod work surface, white or silver column and base (for 60° or 90° curved modules)

	£	€
Group 3	1,253	1,579
Group 4	1,263	1,592
Group 5	1,283	1,617
Group 6	1,368	1,724

Dimensions

Height	720mm
Width	900mm
Depth	1650mm

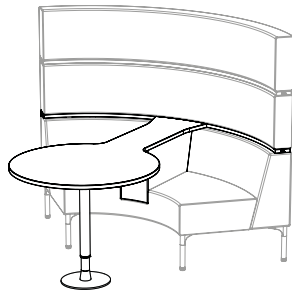

Product information

Work surface top standard finishes, white, oak and walnut, 25mm MFC, for all other finishes please contact Customer Services. Reverse chamfered edges available, prices on application. Please note: The position of the integral work surface support is always centred within the bench. All brackets are available in white or natura.

*Work surfaces need to be specified with a screen

Product options

Power modules are available for each of the work surfaces listed above. For options on power please see page 17 Please contact the Customer Service Team.

Design by Roger Webb Associates

Media Screen Modules

Product Code: SHL2D
Description: 1200 Media Screen

	£	€
Group 3	2,265	2,854
Group 4	2,329	2,935
Group 5	2,457	3,096
Group 6	2,999	3,779

Dimensions

Height	1443mm
Width	1200mm
Depth	730mm



Product Code: SHL3D
Description: 1600 Media Screen

	£	€
Group 3	2,545	3,207
Group 4	2,618	3,299
Group 5	2,764	3,483
Group 6	3,386	4,267

Dimensions

Height	1443mm
Width	1600mm
Depth	730mm



Hive with legs

Media Screen Modules

Design by Roger Webb Associates



Product Code: SHL5D
Description: 1200 back to back Media Screen

	£	€
Group 3	2,797	3,525
Group 4	2,876	3,624
Group 5	3,033	3,822
Group 6	3,702	4,665

Dimensions

Height	1443mm
Width	1200mm
Depth	1330mm

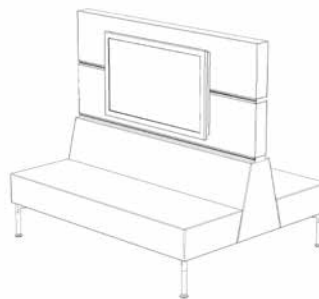

Product Code: SHL6D
Description: 1600 back to back Media Screen

	£	€
Group 3	3,159	3,981
Group 4	3,252	4,098
Group 5	3,438	4,332
Group 6	4,228	5,328

Dimensions

Height	1443mm
Width	1600mm
Depth	1330mm

Please note: Media Screen module does not include audio-visual equipment or TV mounting bracket. Locking bar type brackets are unsuitable as when fitted into the Hive module, access to the TV is only possible from the top or bottom.

Product options

TV mounting bracket	£75
---------------------	-----

Freestanding Tables



Product Code: THV4
Description: Upholstered elliptical coffee table

	£	€
Group 3	880	1,109
Group 4	920	1,160
Group 5	1,000	1,260
Group 6	1,340	1,689

Dimensions

Height	560mm
Width	1260mm
Depth	680mm
Weight	28kg



Product Code: THV5
Description: Upholstered round coffee table

	£	€
Group 3	660	832
Group 4	690	870
Group 5	750	945
Group 6	1,005	1,267

Dimensions

Height	560mm
Diameter	750mm
Weight	19kg

Product information

Wood structure
CMHR foam
Fabric covered base
Tables supplied assembled

Product Code: THV6
Description: Upholstered round coffee table

	£	€
Group 3	710	895
Group 4	740	933
Group 5	800	1,008
Group 6	1,055	1,330

Dimensions

Height	560mm
Diameter	900mm
Weight	25kg

Product options

Table top standard finishes:
white, oak or walnut MFC
Other finishes available POA
For options on power please see page 17.

Steps

Product Code: SSE1**Description: Modular curved upholstered auditorium, seats up to 19 students**

	£	€
Group 0	13,250	15,900
Group 1	14,250	17,100

Dimensions

Height	2050mm
Width	2950mm
Depth	1470mm
Seat height	450mm
Seat depth	450mm
Rail Height	400mm

**Product Code: SSE2****Description: Modular straight upholstered auditorium, seats up to 18 students**

	£	€
Group 0	12,375	14,850
Group 1	13,000	15,600

Dimensions

Height	2050mm
Width	2100mm
Depth	1470mm
Seat height	450mm
Seat depth	450mm
Rail Height	400mm

**Product information**

Steel sub-frame
 CMHR foam seats
 Steel back rails (supplied in EPC colour of choice)
 Replaceable seat cushions
 Integral hydraulic transit device
 enabling movement of modules

Installation information

Prices quoted are for supply only. Installation is needed to be done by Connection's engineers. Prior to acceptance of an order, a Connection engineer will visit the site and confirm delivery and installation requirements free of charge. Once the survey is complete, an installation charge will be advised. Due to the nature and use of this product, Connection will not accept supply only orders.

Cubbi

Design by Roger Webb Associates



Product Code: SCEIA1* (Left - pictured) SCEIA4* (Right)
Description: 800 single acoustic enclosure

	£	€	Dimensions	
Group 3	3,400	4,080	Height	1443mm
Group 4	3,489	4,187	Width	1600mm
Group 5	3,601	4,321	Depth	900mm
Group 6	4,077	4,892		



Product Code: SCEIA2
Description: 800 side-by-side double acoustic enclosure

	£	€	Dimensions	
Group 3	6,533	7,840	Height	1443mm
Group 4	6,659	7,991	Width	1600mm
Group 5	6,911	8,294	Depth	1700mm
Group 6	7,982	9,579		



Product Code: SCEIA3
Description: 800 back-to-back double acoustic enclosure

	£	€	Dimensions	
Group 3	7,453	8,944	Height	1443mm
Group 4	7,600	9,120	Width	3200mm
Group 5	7,894	9,473	Depth	900mm
Group 6	9,144	10,972		



Product Code: SCEIA5
Description: 800 quad acoustic enclosure

	£	€	Dimensions	
Group 3	11,962	14,354	Height	1443mm
Group 4	12,152	14,582	Diameter	3200mm
Group 5	12,532	15,038	Weight	1700mm
Group 6	14,147	16,976		

Product information

Work surface top standard finishes, white, oak and walnut, 25mm MFC, for all other finishes please contact Customer Services.
 Workrail colour finishes white and natura only.
 Power modules not standard.

Special options

Power modules are available in various positions.
 Please contact the Customer Service Team for pricing and further information.

*price does not include task chairs

Design by Roger Webb Associates

Product Code: SCEIB1 (Left) SCEIB4 (Right - pictured)
Description: 800 single acoustic enclosure with bench

	£	€	Dimensions	
Group 3	4,350	5,220	Height	1443mm
Group 4	4,430	5,316	Width	1350mm
Group 5	4,610	5,532	Depth	900mm
Group 6	5,325	6,390	Seat height	433mm



Product Code: SCEIB2
Description: 800 side-by-side double acoustic enclosure with bench

	£	€	Dimensions	
Group 3	7,921	9,505	Height	1443mm
Group 4	8,055	9,666	Width	1350mm
Group 5	8,324	9,989	Depth	1700mm
Group 6	9,467	11,360	Seat height	433mm



Product Code: SCEIB3
Description: 800 back-to-back double acoustic enclosure with bench

	£	€	Dimensions	
Group 3	8,220	9,864	Height	1443mm
Group 4	8,371	10,045	Width	2700mm
Group 5	8,673	10,408	Depth	900mm
Group 6	9,958	11,950	Seat height	433mm



Product Code: SCEIB5
Description: 800 quad acoustic enclosure with bench

	£	€	Dimensions	
Group 3	13,540	16,248	Height	1443mm
Group 4	13,730	16,476	Diameter	2700mm
Group 5	14,110	16,932	Weight	1700mm
Group 6	15,725	18,870	Seat height	433mm

**Product information**

Work surface top standard finishes, white, oak and walnut, 25mm MFC, for all other finishes please contact Customer Services.
 Power modules not as standard

Special options

Power modules are available in various positions.
 Please contact the Customer Service Team for pricing and further information.

Cubbi

Design by Roger Webb Associates



Product Code: SCE2A1 (Left), SCE2A4 (Right - pictured)
Description: 1200 single acoustic enclosure

	£	€	Dimensions	
Group 3	4,195	5,034	Height	1443mm
Group 4	4,250	5,100	Width	1600mm
Group 5	4,440	5,328	Depth	1300mm
Group 6	5,135	6,162		



Product Code: SCE2A2
Description: 1200 side-by-side double acoustic enclosure

	£	€	Dimensions	
Group 3	7,158	8,590	Height	1443mm
Group 4	7,310	8,772	Width	1600mm
Group 5	7,612	9,134	Depth	2500mm
Group 6	8,897	10,677		



Product Code: SCE2A3*
Description: 1200 back-to-back double acoustic enclosure

	£	€	Dimensions	
Group 3	8,498	10,197	Height	1443mm
Group 4	8,649	10,378	Width	3200mm
Group 5	8,951	10,741	Depth	1300mm
Group 6	10,236	12,284		



Product Code: SCE2A5*
Description: 1200 quad acoustic enclosure

	£	€	Dimensions	
Group 3	12,674	15,209	Height	1443mm
Group 4	12,883	15,460	Diameter	3200mm
Group 5	13,301	15,962	Weight	2500mm
Group 6	15,078	18,093		

Product information

Work surface top standard finishes, white, oak and walnut, 25mm MFC, for all other finishes please contact Customer Services.
 Power modules not as standard

Special options

Power modules are available in various positions. Please contact the Customer Service Team for pricing and further information.

*price does not include task chairs

Design by Roger Webb Associates

Product Code: SCE2B1 (Left - pictured), SCE2B4 (Right)
Description: 1200 single acoustic enclosure with bench

	£	€	Dimensions	
Group 3	5,195	6,234	Height	1443mm
Group 4	5,310	6,372	Width	1350mm
Group 5	5,610	6,732	Depth	1300mm
Group 6	6,792	8,150	Seat height	433mm



Product Code: SCE2B2
Description: 1200 side-by-side double acoustic enclosure with bench

	£	€	Dimensions	
Group 3	8,922	10,706	Height	1443mm
Group 4	9,090	10,908	Width	1350mm
Group 5	9,426	11,311	Depth	2500mm
Group 6	10,854	13,024	Seat height	433mm



Product Code: SCE2B3
Description: 1200 back-to-back double acoustic enclosure with bench

	£	€	Dimensions	
Group 3	9,247	11,096	Height	1443mm
Group 4	9,415	11,298	Width	2700mm
Group 5	9,751	11,701	Depth	1300mm
Group 6	11,179	13,415	Seat height	433mm



Product Code: SCE2B5
Description: 1200 quad acoustic enclosure with bench

	£	€	Dimensions	
Group 3	14,579	17,495	Height	1443mm
Group 4	14,807	17,768	Diameter	2700mm
Group 5	15,263	18,316	Weight	2500mm
Group 6	17,201	20,641	Seat height	433mm

**Product information**

Work surface top standard finishes, white, oak and walnut, 25mm MFC, for all other finishes please contact Customer Services.
 Power modules not as standard

Special options

Power modules are available in various positions.
 Please contact the Customer Service Team for pricing and further information.

Tryst

Design by Roger Webb Associates



Product Code: STK1

Description: Armchair with black or polished aluminium legs

	£	€	Dimensions	
Group 3	1,205	1,446	Height	763mm
Group 4	1,235	1,482	Width	980mm
Group 5	1,268	1,522	Depth	810mm
Group 6	1,290	1,548	Seat height	480mm
Leather 1	1,605	1,926	Weight	63kg
Leather 2	1,730	2,076		



Product Code: STK3

Description: Two seater sofa with black or polished aluminium legs

	£	€	Dimensions	
Group 3	2,022	2,427	Height	763mm
Group 4	2,084	2,501	Width	1620mm
Group 5	2,125	2,550	Depth	810mm
Group 6	2,174	2,609	Seat height	480mm
Leather 1	3,112	3,735	Weight	78kg
Leather 2	3,310	3,972		



Product Code: STK5

Description: Armchair with black or polished aluminium legs

	£	€	Dimensions	
Group 3	2,165	2,598	Height	763mm
Group 4	2,221	2,666	Width	2270mm
Group 5	2,280	2,736	Depth	810mm
Group 6	2,328	2,794	Seat height	480mm
Leather 1	3,380	4,056	Weight	106kg
Leather 2	3,580	4,296		



Product information

Supplied unassembled
Steel underframe
Polished cast aluminium legs
Black glides
Hardwood subframe
CMHR foam
Unparalleled comfort due to spring construction

Special options

Dual upholstery POA
Oak legs £232
Power modules* POA
TV bracket up to 40" and 80kg £75

* Power supplied on right hand side of sofa for each module

Design by Roger Webb Associates

Product Code: STK2

Description: High back armchair with black or polished aluminium legs

	£	€	Dimensions	
Group 3	2,690	3,228	Height	1335mm
Group 4	2,762	3,315	Width	980mm
Group 5	2,843	3,412	Depth	810mm
Group 6	2,912	3,495	Seat height	480mm
Leather 1	3,846	4,616	Weight	70kg
Leather 2	4,052	4,863		



Product Code: STK4

Description: High back two seater sofa with black or polished aluminium legs

	£	€	Dimensions	
Group 3	3,408	4,090	Height	1335mm
Group 4	3,516	4,220	Width	1620mm
Group 5	3,604	4,325	Depth	810mm
Group 6	3,705	4,446	Seat height	480mm
Leather 1	5,370	6,444	Weight	85kg
Leather 2	5,708	6,850		



Product Code: STK6

Description: High back three seater sofa with black or polished aluminium legs

	£	€	Dimensions	
Group 3	3,820	4,584	Height	1335mm
Group 4	4,050	4,860	Width	2270mm
Group 5	4,062	4,875	Depth	810mm
Group 6	4,160	4,992	Seat height	480mm
Leather 1	5,910	7,092	Weight	137kg
Leather 2	6,305	7,566		



Product information

Supplied unassembled
 Steel underframe
 Polished cast aluminium legs
 Black glides
 Hardwood subframe
 CMHR foam

Special options

Dual upholstery POA
 Oak legs £232
 Power modules POA



Tryst

Design by Roger Webb Associates



Product Code: STK7
Description: Tryst 2 seater booth with black or polished aluminium legs and integrated work surface

	£	€
Group 3	6,378	7,654
Group 4	6,591	7,909
Group 5	6,875	8,250
Group 6	8,009	9,611

Product Code: STK17
Description: Tryst 2 seater booth without integrated work surface

	£	€
Group 3	5,779	6,935
Group 4	5,992	7,190
Group 5	6,276	7,531
Group 6	7,410	8,892

Dimensions

Height	1335mm
Width	2430mm
Depth	995mm
Seat height	480mm
Weight	90kg



Product Code: STK8
Description: Tryst 4 seater booth with black or polished aluminium legs and integrated work surface

	£	€
Group 3	7,739	9,287
Group 4	8,114	9,737
Group 5	8,607	10,329
Group 6	10,414	12,497

Product Code: STK18
Description: Tryst 4 seater booth without integrated work surface

	£	€
Group 3	7,095	8,514
Group 4	7,470	8,964
Group 5	7,963	9,556
Group 6	9,770	11,724

Dimensions

Height	1335mm
Width	2430mm
Depth	1640mm
Seat height	480mm
Weight	115kg



Product Code: STK9
Description: Tryst 6 seater booth with black or polished aluminium legs and integrated work surface

	£	€
Group 3	8,800	10,559
Group 4	9,233	11,080
Group 5	9,791	11,749
Group 6	12,056	14,468

Product Code: STK19
Description: Tryst 6 seater booth without integrated work surface

	£	€
Group 3	8,043	9,651
Group 4	8,476	10,172
Group 5	9,034	10,841
Group 6	11,299	13,560

Dimensions

Height	1335mm
Width	2430mm
Depth	2290mm
Seat height	480mm
Weight	145kg

Product information

Supplied unassembled
 Steel underframe
 Black or polished aluminium legs
 Black glides
 Hardwood subframe
 CMHR foam
 Unparalleled confort due to spring construction

Work surface top standard finishes, white, oak and walnut, 25mm MFC. Other finishes please contact Customer Services.

Special options

Dual upholstery POA
 Oak legs £464
 Power modules POA
 TV Bracket up to 40" and 80 Kg £75

Reverse chamfered edges:
 STK7 £150
 STK8 £185
 STK9 £210

*Media screen not included in pricing
 *Images above with oak legs, refer to special options for additional pricing

Tryst

Design by Roger Webb Associates

Product Code: STK10

Description: Tryst 2 seater low-back console unit with black or polished aluminium legs

	£	€	Dimensions	
Group 3	3,708	4,450	Height	763mm
Group 4	3,838	4,605	Width	2286mm
Group 5	4,009	4,810	Depth	810mm
Group 6	4,762	5,714	Seat height	480mm
			Weight	125kg



Product Code: STK11

Description: Tryst 2 seater high-back console unit with black or polished aluminium legs

	£	€	Dimensions	
Group 3	4,187	5,024	Height	1135mm
Group 4	4,351	5,221	Width	2286mm
Group 5	4,611	5,534	Depth	810mm
Group 6	5,654	6,785	Seat height	480mm
			Weight	134kg



Product information

Supplied unassembled
 Steel underframe
 Black or polished aluminium legs
 Black glides
 Hardwood subframe
 CMHR foam
 Oak veneer console table

Special options

Dual upholstery POA
 Oak legs £232
 Lamp POA
 Power modules POA
 Other console table finishes POA

*Images above with oak legs, refer to special options for additional pricing



Tryst

Design by Roger Webb Associates

Product Code: STK20
Description: Tryst 2 Seater Booth Low Back With Table



	£	€	Dimensions	
Group 3	3,259	3,911	Height	763mm
Group 4	3,329	3,995	Width	2430mm
Group 5	3,405	4,086	Depth	995mm
Group 6	3,459	4,151	Seat height	480mm

Product Code: STK21
Description: Tryst 4 Seater Booth Low Back With Table



	£	€	Dimensions	
Group 3	4,893	5,872	Height	763mm
Group 4	5,027	6,033	Width	2430mm
Group 5	5,119	6,143	Depth	1640mm
Group 6	5,227	6,273	Seat height	480mm

Product Code: STK22
Description: Tryst 6 Seater Booth Low Back With Table



	£	€	Dimensions	
Group 3	5,179	6,215	Height	763mm
Group 4	5,301	6,362	Width	2430mm
Group 5	5,429	6,515	Depth	2290mm
Group 6	5,535	6,642	Seat height	480mm

Product information

- Supplied unassembled
- Steel underframe
- Black or polished aluminium legs
- Black glides
- Hardwood subframe
- CMHR foam

Special options

- Dual upholstery POA
- Oak legs £464
- Lamp POA
- Power modules POA
- Other console table finishes POA

Design by Roger Webb Associates

Product Code: STK23
Description: Tryst 2 Seater Booth Low Back No Table

	£	€	Dimensions	
Group 3	2,660	3,192	Height	763mm
Group 4	2,730	3,276	Width	2430mm
Group 5	2,806	3,368	Depth	995mm
Group 6	2,860	3,432	Seat height	480mm



Product Code: STK24
Description: Tryst 4 Seater Booth Low Back No Table

	£	€	Dimensions	
Group 3	4,294	5,153	Height	763mm
Group 4	4,428	5,314	Width	2430mm
Group 5	4,520	5,424	Depth	995mm
Group 6	4,628	5,554	Seat height	480mm



Product Code: STK25
Description: Tryst 6 Seater Booth Low Back No Table

	£	€	Dimensions	
Group 3	4,580	5,496	Height	763mm
Group 4	4,702	5,643	Width	2430mm
Group 5	4,830	5,796	Depth	2290mm
Group 6	4,936	5,924	Seat height	480mm

**Product information**

Supplied unassembled
 Steel underframe
 Black or polished aluminium legs
 Black glides
 Hardwood subframe
 CMHR foam
 Oak veneer console table

Special options

Dual upholstery POA
 Oak legs £464
 Lamp POA
 Power modules POA
 Other console table finishes POA

*Images above with oak legs, refer to special options for additional pricing



Tryst

Design by Roger Webb Associates



Product Code: STK26
Description: Tryst 2 Seater Booth High Back With Integrated Work Surface

	£	€	Dimensions	
Group 3	6,278	7,534	Height	1335mm
Group 4	6,491	7,790	Width	2430mm
Group 5	6,775	8,130	Depth	995mm
Group 6	7,909	9,491	Seat height	480mm



Product Code: STK27
Description: Tryst 4 Seater Booth High Back With Integrated Work Surface

	£	€	Dimensions	
Group 3	7,639	9,167	Height	1335mm
Group 4	8,014	9,617	Width	2430mm
Group 5	8,507	10,209	Depth	1640mm
Group 6	10,314	12,377	Seat height	480mm



Product Code: STK28
Description: Tryst 6 Seater Booth High Back With Integrated Work Surface

	£	€	Dimensions	
Group 3	8,700	10,440	Height	1335mm
Group 4	9,133	10,960	Width	2430mm
Group 5	9,691	11,630	Depth	2290mm
Group 6	11,956	14,348	Seat height	480mm

Product information

Supplied unassembled
 Steel underframe
 Black or polished aluminium legs
 Black glides
 Hardwood subframe
 CMHR foam

Special options

Dual upholstery POA
 Lamp POA
 Power modules POA
 Other console table finishes POA

Design by Roger Webb Associates

Product Code: STK29
Description: Tryst 2 Seater Booth High Back No Integrated Work Surface

	£	€	Dimensions	
Group 3	5,679	6,815	Height	1335mm
Group 4	5,892	7,071	Width	2430mm
Group 5	6,176	7,412	Depth	995mm
Group 6	7,310	8,772	Seat height	480mm



Product Code: STK30
Description: Tryst 4 Seater Booth High Back No Integrated Work Surface

	£	€	Dimensions	
Group 3	6,995	8,394	Height	1335mm
Group 4	7,370	8,844	Width	2430mm
Group 5	7,863	9,436	Depth	1640mm
Group 6	9,670	11,604	Seat height	480mm



Product Code: STK31
Description: Tryst 6 Seater Booth High Back No Integrated Work Surface

	£	€	Dimensions	
Group 3	7,943	9,532	Height	1335mm
Group 4	8,376	10,052	Width	2430mm
Group 5	8,934	10,721	Depth	2290mm
Group 6	11,199	13,439	Seat height	480mm

**Product information**

Supplied unassembled
 Steel underframe
 Black or polished aluminium legs
 Black glides
 Hardwood subframe
 CMHR foam
 Oak veneer console table

Special options

Dual upholstery POA
 Oak legs £464
 Lamp POA
 Power modules POA
 Other console table finishes POA

*Images above with oak legs, refer to special options for additional pricing



Tryst

Design by Roger Webb Associates



Product Code: STK32
Description: Low Back Tryst Assymetrical L Shape - Left Handed

	£	€
Group 3	4,012	4,815
Group 4	4,130	4,956
Group 5	4,230	5,076
Group 6	4,327	5,193

Product Code: STK33
Description: Low Back Tryst Assymetrical L Shape - Right Handed

	£	€
Group 3	4,012	4,815
Group 4	4,130	4,956
Group 5	4,230	5,076
Group 6	4,327	5,193

Dimensions	
Height	763mm
Width	2447mm
Depth	1635mm
Seat height	480mm



Product Code: STK34
Description: Low Back Tryst Assymetrical L Shape - Left Handed with Corner Table

	£	€
Group 3	4,512	5,415
Group 4	4,613	5,536
Group 5	4,730	5,676
Group 6	4,827	5,793

Product Code: STK35
Description: Low Back Tryst Assymetrical L Shape - Right Handed with Corner Table

	£	€
Group 3	4,512	5,415
Group 4	4,613	5,536
Group 5	4,730	5,676
Group 6	4,827	5,793

Dimensions	
Height	763mm
Width	2447mm
Depth	1635mm
Seat height	480mm



Product Code: STK36
Description: High Back Tryst Assymetrical L Shape - Left Handed

	£	€
Group 3	6,978	8,374
Group 4	7,316	8,780
Group 5	7,416	8,900
Group 6	7,615	9,138

Product Code: STK37
Description: High Back Tryst Assymetrical L Shape - Right Handed

	£	€
Group 3	6,978	8,374
Group 4	7,316	8,780
Group 5	7,416	8,900
Group 6	7,615	9,138

Dimensions	
Height	1335mm
Width	2447mm
Depth	1635mm
Seat height	480mm



Product Code: STK38
Description: High Back Tryst Assymetrical L Shape - Left Handed with Corner Table

	£	€
Group 3	7,478	8,974
Group 4	7,816	9,380
Group 5	7,916	9,500
Group 6	8,115	9,738

Product Code: STK39
Description: High Back Tryst Assymetrical L Shape - Right Handed with Corner Table

	£	€
Group 3	7,478	8,974
Group 4	7,816	9,380
Group 5	7,916	9,500
Group 6	8,115	9,738

Dimensions	
Height	1335mm
Width	2447mm
Depth	1635mm
Seat height	480mm

Product information
Supplied unassembled
Steel underframe
Black or polished aluminium legs
Black glides
Hardwood subframe
CMHR foam

Special options
Dual upholstery POA
Lamp POA
Power modules POA
Other console table finishes POA

Design by Roger Webb Associates

Product Code: STK40
Description: Low Back Tryst Symmetrical L Shape

	£	€	Dimensions	
Group 3	4,080	4,896	Height	763mm
Group 4	4,192	5,031	Width	2447mm
Group 5	4,310	5,172	Depth	2447mm
Group 6	4,406	5,288	Seat height	480mm



Product Code: STK41
Description: Low Back Tryst Symmetrical L Shape with Corner Table

	£	€	Dimensions	
Group 3	4,580	5,496	Height	763mm
Group 4	4,692	5,631	Width	2447mm
Group 5	4,810	5,772	Depth	2447mm
Group 6	4,906	5,888	Seat height	480mm

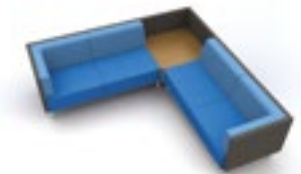

Product Code: STK42
Description: High Back Tryst Symmetrical L Shape

	£	€	Dimensions	
Group 3	7,028	8,434	Height	1335mm
Group 4	7,366	8,840	Width	2447mm
Group 5	7,466	8,960	Depth	2447mm
Group 6	7,665	9,198	Seat height	480mm



Product Code: STK43
Description: High Back Tryst Symmetrical L Shape with Corner Table

	£	€	Dimensions	
Group 3	7,428	8,914	Height	1335mm
Group 4	7,766	9,320	Width	2447mm
Group 5	7,866	9,440	Depth	2447mm
Group 6	8,065	9,678	Seat height	480mm

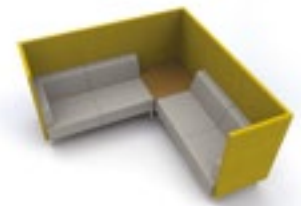
**Product information**

Supplied unassembled
 Steel underframe
 Black or polished aluminium legs
 Black glides
 Hardwood subframe
 CMHR foam

Special options

Dual upholstery POA
 Lamp POA
 Power modules POA
 Other console table finishes POA

Tryst

Design by Roger Webb Associates

Product Code: STK44
Description: Low Back Tryst U Shape



	£	€	Dimensions	
Group 3	5,902	7,083	Height	763mm
Group 4	6,076	7,292	Width	2447mm
Group 5	6,235	7,482	Depth	3272mm
Group 6	6,380	7,656	Seat height	480mm

Product Code: STK45
Description: Low Back Tryst U Shape with Corner Tables



	£	€	Dimensions	
Group 3	6,402	7,683	Height	763mm
Group 4	6,576	7,892	Width	2447mm
Group 5	6,753	8,104	Depth	3272mm
Group 6	6,880	8,256	Seat height	480mm

Product Code: STK46
Description: High Back Tryst U Shape



	£	€	Dimensions	
Group 3	10,548	12,658	Height	1335mm
Group 4	11,116	13,340	Width	2447mm
Group 5	11,228	13,474	Depth	3272mm
Group 6	11,525	13,830	Seat height	480mm

Product Code: STK47
Description: High Back Tryst U Shape with Corner Tables



	£	€	Dimensions	
Group 3	11,048	13,258	Height	1335mm
Group 4	11,616	13,940	Width	2447mm
Group 5	11,728	14,074	Depth	3272mm
Group 6	12,025	14,430	Seat height	480mm

Product information

Supplied unassembled
 Steel underframe
 Black or polished aluminium legs
 Black glides
 Hardwood subframe
 CMHR foam

Special options

Dual upholstery POA
 Lamp POA
 Power modules POA
 Other console table finishes POA

Design by Roger Webb Associates

Product Code: STK48
Description: Low Back Tryst 4 Seater

	£	€	Dimensions
Group 3	3,844	4,613	Height 763mm
Group 4	3,968	4,762	Width 2447mm
Group 5	3,940	4,728	Depth 810mm
Group 6	4,148	4,978	Seat height 480mm



Product Code: STK49
Description: High Back Tryst 4 Seater

	£	€	Dimensions
Group 3	6,416	7,700	Height 1335mm
Group 4	6,632	7,959	Width 2447mm
Group 5	6,808	8,170	Depth 810mm
Group 6	7,010	8,412	Seat height 480mm



Product Code: TSTC/RECXXXOAK/OA4L
Description: Coffee table with oak frame and oak veneer top

	£	€	Dimensions
Price	620	744	Height 450mm
			Width 700mm
			Length 1360mm



Product Code: TSTK/RND0420WHM/BLK
Description: Beam Writing Table with black tubular steel frame

	£	€	Dimensions
Price	356	428	Height 710mm
			Diameter 420mm

**Product information**

Supplied unassembled
 Steel underframe
 Black or polished aluminium legs
 Black glides
 Hardwood subframe
 CMHR foam
 Oak veneer console table

Special options

Dual upholstery POA
 Lamp POA
 Power modules POA
 Other console table finishes POA

*Images above with oak legs, refer to special options for additional pricing







Soft Seating



Austen

Design by Roger Webb Associates



Product Code: MAUID
Description: Chair with silver or white 4 leg base

	£	€	Dimensions	
Group 0	523	628	Height	770mm
Group 1	550	660	Width	760mm
Group 2	576	692	Depth	600mm
Group 3	627	753	Seat height	420mm
Group 4	650	780	Weight	9kg
Group 5	793	952		
Group 6	922	1,107		



Product Code: MAUIA
Description: Chair with silver or white wire sled base

	£	€	Dimensions	
Group 0	552	663	Height	810mm
Group 1	578	694	Width	760mm
Group 2	604	725	Depth	600mm
Group 3	655	786	Seat height	430mm
Group 4	678	814	Weight	11kg
Group 5	821	986		
Group 6	950	1,140		



Product Code: MAUIC
Description: Chair with white or silver column, white or polished aluminium swivel 4 star base

	£	€	Dimensions	
Group 0	616	740	Height	860mm
Group 1	643	772	Width	760mm
Group 2	669	803	Depth	600mm
Group 3	720	864	Seat height	470mm
Group 4	743	892	Weight	12kg
Group 5	886	1,064		
Group 6	1,015	1,218		



Product Code: TSWC/RND0800GLX/SI4S
Description: Coffee table with silver column, or polished aluminium 4 star base*

	£	€	Dimensions	
Frosted Glass	406	488	Height	400mm
			Diameter	800mm
			Weight	17kg

Product information

Cold cured moulded foam
MAUIA silver /white painted steel wire base
MAUIC white or silver steel column and 4 star base
MAUID white or silver steel legs, black nylon feet

Special options

	£	€
Dual upholstery, add (per unit)	42	51
5 or more	FOC	
MAUID/MAUIA chrome base	POA	

Product information

Tables supplied unassembled
10mm frosted safety glass
White or silver steel 4 star base

*See page 144 for more complementary table options

Austen

Design by Roger Webb Associates

Product Code: MAU1G
Description: Chair with beech 4 leg base

	£	€	Dimensions	
Group 0	511	614	Height	820mm
Group 1	538	646	Width	760mm
Group 2	564	677	Depth	600mm
Group 3	615	738	Seat height	470mm
Group 4	638	766	Weight	9kg
Group 5	781	938		
Group 6	910	1,092		



Product Code: TAUC/SQLO650FGL/BH4L
Description: Coffee table with square frosted glass top, beech 4 leg base

	£	€	Dimensions	
Frosted Glass	280	336	Height	480mm
			Width	650mm
			Depth	650mm
			Weight	13kg



Product Code: TAUC/RND0800FGL/BH4L
Description: Coffee table with round frosted glass top, beech 4 leg base

	£	€	Dimensions	
Frosted Glass	393	475	Height	480mm
			Diameter	800mm
			Weight	15kg



Product Code: TAUC/RND0660FGL/BH4L
Description: Coffee table with round frosted glass top, beech 4 leg base

	£	€	Dimensions	
Frosted Glass	285	342	Height	480mm
			Diameter	660mm
			Weight	11kg

**Product information**

Seat: Cold cured moulded foam
 Beech veneer plywood legs

Table: Tables supplied unassembled
 10mm frosted safety glass
 Beech veneer plywood legs

Special options

	£	€
Dual upholstery, add (per unit)	42	51
5 or more (chairs)	FOC	
For other chair leg finishes	POA	
For other table leg finishes	POA	



Blok

Design by Roger Webb Associates



Product Code: SBX1
Description: Armchair

	£	€		£	€	Dimensions	
Group 0	771	926	Group 6	1,336	1,604	Height	710mm
Group 1	797	957	Group 7	1,621	1,946	Width	860mm
Group 2	840	1,008	Leather 1	1,269	1,523	Depth	745mm
Group 3	949	1,139	Leather 2	1,481	1,778	Seat height	435mm
Group 4	985	1,182	Leather 3	1,696	2,036	Weight	40kg
Group 5	1,076	1,292					



Product Code: SBX2
Description: Two seat sofa

	£	€		£	€	Dimensions	
Group 0	1,118	1,342	Group 6	1,924	2,309	Height	710mm
Group 1	1,157	1,389	Group 7	2,326	2,792	Width	1400mm
Group 2	1,220	1,464	Leather 1	1,775	2,130	Depth	745mm
Group 3	1,363	1,636	Leather 2	2,069	2,483	Seat height	435mm
Group 4	1,417	1,701	Leather 3	2,362	2,835	Weight	48kg
Group 5	1,551	1,862					



Product Code: SBX3
Description: Three seat sofa

	£	€		£	€	Dimensions	
Group 0	1,561	1,874	Group 6	2,774	3,329	Height	710mm
Group 1	1,614	1,937	Group 7	3,372	4,047	Width	1910mm
Group 2	1,712	2,055	Leather 1	2,534	3,041	Depth	745mm
Group 3	1,929	2,315	Leather 2	2,945	3,534	Seat height	435mm
Group 4	2,011	2,414	Leather 3	3,423	4,108	Weight	47kg
Group 5	2,213	2,656					

Product information

Silver legs with black feet
 Hardwood frames, web sprung seat
 CMHR foam

Certification

BS EN 15373: 2007

Special options

	£	€
Dual upholstery, add (per unit)	42	51
Over 4 units	FOC	

Bubble

Design by Roger Webb Associates

Product Code: SBB1/A1**Description: Stool, silver wire frame**

	£	€
Group 0	294	353
Group 1	304	365
Group 2	317	381
Group 3	334	401
Group 4	344	413
Group 5	364	437
Group 6	449	539
Group 7	484	581

Dimensions

Height	400mm
Width	527mm
Depth	660mm
Weight	10kg

**Product Code: SBB1/C1****Description: Stool, silver pedestal base**

	£	€
Group 0	390	468
Group 1	400	480
Group 2	412	495
Group 3	430	516
Group 4	440	528
Group 5	460	552
Group 6	545	654
Group 7	580	696

Dimensions

Height	400mm
Width	527mm
Depth	660mm
Weight	25kg

**Product Code: TBBC/OVLXXXXWHM/SIWI****Description: Table, silver wire frame**

	£	€
White	207	249

Dimensions

Height	318mm
Width	527mm
Depth	660mm
Weight	6kg

**Product information**

Seats: Silver wire or pedestal base
CMHR foam
Not suitable for vinyl or leather
upholstery

Table: 18mm MFC top
Silver wire frame

Special options

Chrome steel wire frame

POA

Certification

BS EN 15373: 2007
BS EN 1022: 2005



Bud

Design by Roger Webb Associates



Product Code: SBD1
Description: Bud Chair Wire Frame

	£	€		£	€	Dimensions	
Group 0	508	610	Group 6	818	982	Height	805mm
Group 1	528	634	Group 7	888	1,066	Width	670mm
Group 2	553	664	Leather 1	748	898	Depth	570mm
Group 3	588	706	Leather 2	871	1,046	Seat height	460mm
Group 4	608	730	Leather 3	995	1,194		
Group 5	648	778					



Product Code: SBD2
Description: Bud Chair 4 leg Oak Wood Frame

	£	€		£	€	Dimensions	
Group 0	560	672	Group 6	870	1,044	Height	805mm
Group 1	580	696	Group 7	940	1,128	Width	670mm
Group 2	605	726	Leather 1	800	960	Depth	570mm
Group 3	640	768	Leather 2	923	1,108	Seat height	460mm
Group 4	660	792	Leather 3	1,047	1,257		
Group 5	700	840					



Product Code: SBD3
Description: Bud Chair 4 Star Fixed

	£	€		£	€	Dimensions	
Group 0	549	659	Group 6	859	1,031	Height	805mm
Group 1	569	683	Group 7	929	1,115	Width	670mm
Group 2	594	713	Leather 1	789	947	Depth	570mm
Group 3	629	755	Leather 2	912	1,095	Seat height	460mm
Group 4	649	779	Leather 3	1,036	1,244		
Group 5	689	827					



Product Code: SBD4
Description: Bud Chair 4 Star Swivel

	£	€		£	€	Dimensions	
Group 0	608	730	Group 6	918	1,102	Height	805mm
Group 1	628	754	Group 7	988	1,186	Width	670mm
Group 2	653	784	Leather 1	848	1,018	Depth	570mm
Group 3	688	826	Leather 2	971	1,166	Seat height	460mm
Group 4	708	850	Leather 3	1,095	1,314		
Group 5	748	898					

Design by Roger Webb Associates

Product Code: GBD2

Description: Bud Stool 4 leg Oak Wood Frame

	£	€		£	€
Group 0	350	420	Group 6	459	551
Group 1	357	429	Group 7	483	580
Group 2	366	440	Leather 1	434	521
Group 3	378	454	Leather 2	477	573
Group 4	385	462	Leather 3	521	626
Group 5	399	479			

Dimensions

Height	460mm
Width	445mm
Depth	445mm
Seat height	460mm



Product Code: TBDC/RND0660GLX/OA4L

Description: Bud Table 660 Glass Oak Wooden Frame

	£	€
Price	335	402

Dimensions

Height	475mm
Width	660mm
Depth	660mm



Product Code: TBDC/RND0800GLX/OA4L

Description: Bud Table 800 Glass Oak Wooden Frame

	£	€
Price	367	441

Dimensions

Height	475mm
Width	800mm
Depth	800mm



Check

Design by High Design



Product Code: SCK1A
Description: Armchair

	£	€		£	€	Dimensions	
Group 0	1,290	1,548	Group 6	1,912	2,294	Height	758mm
Group 1	1,329	1,595	Group 7	2,238	2,685	Width	940mm
Group 2	1,389	1,666	Leather 1	1,856	2,227	Depth	900mm
Group 3	1,487	1,785	Leather 2	2,474	2,968	Seat height	420mm
Group 4	1,547	1,856	Leather 3	2,642	3,170	Weight	30kg
Group 5	1,645	1,974					



Product Code: SCK2A
Description: Two seat sofa

	£	€		£	€	Dimensions	
Group 0	1,732	2,079	Group 6	2,618	3,142	Height	758mm
Group 1	1,788	2,146	Group 7	3,083	3,699	Width	1620mm
Group 2	1,873	2,247	Leather 1	2,481	2,977	Depth	900mm
Group 3	2,013	2,416	Leather 2	3,308	3,970	Seat height	420mm
Group 4	2,098	2,517	Leather 3	3,529	4,235	Weight	55kg
Group 5	2,239	2,686					



Product Code: SCK3A
Description: Three seat sofa

	£	€		£	€	Dimensions	
Group 0	2,297	2,756	Group 6	3,420	4,104	Height	758mm
Group 1	2,368	2,842	Group 7	4,009	4,810	Width	2300mm
Group 2	2,477	2,973	Leather 1	3,111	3,734	Depth	900mm
Group 3	2,652	3,182	Leather 2	4,229	5,074	Seat height	420mm
Group 4	2,759	3,311	Leather 3	4,581	5,498	Weight	68kg
Group 5	2,980	3,576					



Product Code: TCKC/RECXXXOAV/CH4L
Description: Coffee table with oak veneer

	£	€	Dimensions	
Oak	539	647	Height	305mm
			Width	600mm
			Depth	1200mm
			Weight	20kg

Product information
 Chromed steel underframe,
 grey nylon glides
 Hardwood subframe
 CMHR Foam

Columbus

Design by Jones & Partners

Product Code: SCL1**Description: High back armchair with white or silver wire base**

	£	€		£	€	Dimensions	
Group 1	964	1,157	Group 6	1,428	1,714	Height	1090mm
Group 2	1,004	1,205	Group 7	1,540	1,848	Width	740mm
Group 3	1,060	1,272	Leather 1	1,316	1,580	Depth	800mm
Group 4	1,092	1,311	Leather 2	1,513	1,816	Seat height	440mm
Group 5	1,156	1,388	Leather 3	1,711	2,054	Weight	18kg

**Product Code: SCL2****Description: High back armchair with fixed white or silver trumpet base**

	£	€		£	€	Dimensions	
Group 1	1,065	1,278	Group 6	1,529	1,835	Height	1060mm
Group 2	1,105	1,326	Group 7	1,641	1,970	Width	740mm
Group 3	1,161	1,394	Leather 1	1,417	1,701	Depth	800mm
Group 4	1,193	1,432	Leather 2	1,615	1,938	Seat height	410mm
Group 5	1,257	1,509	Leather 3	1,813	2,176	Weight	21kg

**Product Code: SCL3****Description: High back armchair with swivel white or silver trumpet base**

	£	€		£	€	Dimensions	
Group 1	1,110	1,332	Group 6	1,574	1,889	Height	1060mm
Group 2	1,150	1,380	Group 7	1,686	2,024	Width	740mm
Group 3	1,206	1,448	Leather 1	1,462	1,755	Depth	800mm
Group 4	1,238	1,486	Leather 2	1,660	1,992	Seat height	410mm
Group 5	1,302	1,563	Leather 3	1,858	2,230	Weight	21kg

**Product information**

Cold cured moulded foam
Steel underframes
SCL1 Steel wire frame
SCL2/SCL3 Aluminium spun base

Product information

Chrome base POA



Crown

Design by Roger Webb Associates



Product Code: SCW1
Description: Wire frame

	£	€
Group 0	638	766
Group 1	658	790
Group 2	683	820
Group 3	718	862
Group 4	738	886
Group 5	778	934

	£	€
Group 6	948	1,138
Group 7	1,018	1,222
Leather 1	878	1,054
Leather 2	1,001	1,202
Leather 3	1,125	1,350

Dimensions	
Height	770mm
Width	635mm
Depth	580mm
Seat height	450mm



Product Code: SCW2
Description: 4 Leg oak wood frame

	£	€
Group 0	666	800
Group 1	686	824
Group 2	711	854
Group 3	746	896
Group 4	766	920
Group 5	806	968

	£	€
Group 6	976	1,172
Group 7	1,046	1,256
Leather 1	906	1,088
Leather 2	1,030	1,236
Leather 3	1,154	1,385

Dimensions	
Height	770mm
Width	635mm
Depth	580mm
Seat height	450mm



Product Code: SCW3
Description: 4 Star fixed

	£	€
Group 0	666	800
Group 1	686	824
Group 2	711	854
Group 3	746	896
Group 4	766	920
Group 5	806	968

	£	€
Group 6	976	1,172
Group 7	1,046	1,256
Leather 1	906	1,088
Leather 2	1,029	1,235
Leather 3	1,153	1,384

Dimensions	
Height	770mm
Width	635mm
Depth	580mm
Seat height	450mm



Product Code: SCW4
Description: 4 Star swivel

	£	€
Group 0	717	861
Group 1	737	885
Group 2	762	915
Group 3	797	957
Group 4	817	981
Group 5	857	1,029

	£	€
Group 6	1,027	1,233
Group 7	1,097	1,317
Leather 1	957	1,149
Leather 2	1,080	1,296
Leather 3	1,204	1,445

Dimensions	
Height	770mm
Width	635mm
Depth	580mm
Seat height	450mm

Cubix

Design by Roger Webb Associates

Product Code: SCU1A**Description: Upholstered square stool with glides**

	£	€		£	€
Group 0	250	300	Group 6	456	548
Group 1	271	326	Group 7	500	600
Group 2	289	347	Leather 1	403	484
Group 3	311	374	Leather 2	480	576
Group 4	325	390	Leather 3	559	671
Group 5	350	420			

Dimensions

Height	450mm
Width	450mm
Depth	450mm
Weight	11kg

**Product Code: SCU1B****Description: Upholstered circular stool with glides**

	£	€		£	€
Group 1	269	323	Group 6	554	665
Group 2	284	341	Group 7	619	743
Group 3	311	374	Leather 1	476	572
Group 4	343	412	Leather 2	590	708
Group 5	362	435	Leather 3	703	844
	398	478			

Dimensions

Height	450mm
Diameter	460mm
Weight	7kg

**Product information**

Black nylon glides
CMHR foam
Wooden subframe

Product information

	£	\$
SCUIA/SCUIB castors, add	34	41
Dual upholstery, add (per unit)	42	51
5 or more units	FOC	

Dixi

Design by Ratio Design Associates

Product Code: SDX1**Description: Fixed base tub chair with glides**

	£	€
Group 3	1,141	1,370
Group 4	1,186	1,424
Group 5	1,276	1,532
Group 6	1,658	1,990
Group 7	1,816	2,180

Product Code: SDX2**Description: Swivel base tub chair**

	£	€
Group 3	1,380	1,656
Group 4	1,425	1,710
Group 5	1,515	1,818
Group 6	1,898	2,278
Group 7	2,055	2,466

Dimensions

Height	1100mm
Width	830mm
Depth	770mm
Seat height	440mm
Weight	33kg/48kg

**Product information**

Cold cured moulded foam
Steel and wood subframe

Special options

Dual upholstery

POA

Certification

BS EN 16139: 2013 Level 1



Gloss

Design by David Fox Design



Product Code: MGL1D
Description: Chair, 4 leg chrome frame

	£	€		£	€	Dimensions	
Group 0	424	509	Group 6	763	916	Height	800mm
Group 1	432	519	Group 7	838	1,006	Width	700mm
Group 2	482	579	Leather 1	674	809	Depth	670mm
Group 3	519	623	Leather 2	804	965	Seat height	475mm
Group 4	540	648	Leather 3	937	1,125	Weight	8kg
Group 5	583	700					



Product Code: MGL1B
Description: Chair, chrome sled frame

	£	€		£	€	Dimensions	
Group 0	501	602	Group 6	844	1,013	Height	800mm
Group 1	509	611	Group 7	919	1,103	Width	700mm
Group 2	561	674	Leather 1	753	904	Depth	670mm
Group 3	599	719	Leather 2	885	1,062	Seat height	475mm
Group 4	620	744	Leather 3	1,017	1,221	Weight	10kg
Group 5	662	795					



Product Code: MGL1E
Description: Chair, fixed 4 star raised polished aluminium base, silver column

	£	€		£	€	Dimensions	
Group 0	543	652	Group 6	761	914	Height	800mm
Group 1	550	660	Group 7	812	975	Width	700mm
Group 2	573	688	Leather 1	701	842	Depth	670mm
Group 3	598	718	Leather 2	789	947	Seat height	475mm
Group 4	611	734	Leather 3	876	1,052	Weight	13kg
Group 5	640	768					



Product Code: TGLC/RND0660WHM/SI4S (White), TGLC/RND0660WAM/SI4S (Walnut), TGLC/RND0660GLX/SI4S (Frosted glass)
Description: Coffee table, round top, 4 star raised polished aluminium base, silver column

	£	€	Dimensions	
White/Walnut	266	320	Height	400mm
Frosted Glass	445	534	Width	660mm
			Weight	10kg (white/walnut) 12kg (glass)

Product information

Chairs: White recyclable ABS shell
 CMHR foam
 Chromed steel frame
 Grey nylon feet

Table: Tables supplied unassembled
 18mm MFC top, ABS edging 10mm
 frosted safety glass. Whilst every effort
 is made to ensure parity of colour on
 our table top finishes, the company
 cannot guarantee an exact match on
 any timber product.

Special options

	£	\$
Chair:		
MGL1E swivel base, add	45	54
Dual upholstery, add (per unit)	42	51
5 or more	FOC	
MGL1E chrome column	POA	
MGL1D/ MGL1B white frame	FOC	
Table:		
Beech veneer, add	104	125
Oak veneer, add	67	81
Other table top finishes	POA	
Chrome column	POA	

Certification

BS EN 15373: 2007
 Coffee table (wood top)
 BS EN 15372: 2008

Halo

Design by David Fox Design

Product Code: MHA3C

Description: Chair, silver wire frame, beech shell

	£	€		£	€	Dimensions	
Group 0	658	790	Group 6	842	1,011	Height	755mm
Group 1	667	801	Group 7	883	1,060	Width	650mm
Group 2	685	822	Leather 1	791	950	Depth	600mm
Group 3	707	849	Leather 2	864	1,037	Seat height	450mm
Group 4	717	861	Leather 3	936	1,124	Weight	14kg
Group 5	741	890					

**Product Code: MHA3G**

Description: Chair, fixed silver column, 4 star polished aluminium raised base, beech shell

	£	€		£	€	Dimensions	
Group 0	758	910	Group 6	930	1,116	Height	755mm
Group 1	767	921	Group 7	968	1,162	Width	650mm
Group 2	783	940	Leather 1	883	1,060	Depth	600mm
Group 3	803	964	Leather 2	950	1,140	Seat height	450mm
Group 4	813	976	Leather 3	1,020	1,224	Weight	14kg
Group 5	835	1,002					

**Product Code: MHC3A**

Description: Compact dining chair, silver 4 leg frame, fully upholstered inner and outer shell

	£	€		£	€	Dimensions	
Group 0	508	610	Group 6	802	963	Height	780mm
Group 1	515	618	Group 7	868	1,042	Width	588mm
Group 2	543	652	Leather 1	717	861	Depth	600mm
Group 3	579	695	Leather 2	839	1,007	Seat height	480mm
Group 4	597	717	Leather 3	958	1,150	Weight	12kg
Group 5	636	764					

**Product Code: MHC1A**

Description: Compact dining chair, silver 4 leg frame, beech shell

	£	€		£	€	Dimensions	
Group 0	558	670	Group 6	768	922	Height	780mm
Group 1	565	678	Group 7	814	977	Width	588mm
Group 2	586	704	Leather 1	710	852	Depth	600mm
Group 3	611	734	Leather 2	793	952	Seat height	480mm
Group 4	624	749	Leather 3	878	1,054	Weight	11kg
Group 5	650	780					



Halo

Design by David Fox Design



Product Code: MHC1C

Description: Compact dining chair, fixed silver column, 4 star polished aluminium raised base, beech shell

	£	€		£	€	Dimensions	
Group 0	736	884	Group 6	878	1,054	Height	755mm
Group 1	743	892	Group 7	910	1,092	Width	588mm
Group 2	756	908	Leather 1	839	1,007	Depth	600mm
Group 3	772	927	Leather 2	897	1,077	Seat height	450mm
Group 4	782	939	Leather 3	954	1,145	Weight	13kg
Group 5	801	962					



Product Code: MHC3C

Description: Compact chair, fixed silver column, 4 star polished aluminium raised base, fully upholstered shell

	£	€		£	€	Dimensions	
Group 0	611	734	Group 6	893	1,072	Height	755mm
Group 1	625	750	Group 7	957	1,149	Width	588mm
Group 2	651	782	Leather 1	815	978	Depth	600mm
Group 3	684	821	Leather 2	928	1,114	Seat height	450mm
Group 4	702	843	Leather 3	1,041	1,250	Weight	13kg
Group 5	738	886					



Product Code: GHA3B

Description: Bar stool with silver wire frame, beech shell

	£	€		£	€	Dimensions	
Group 0	685	822	Group 6	864	1,037	Height	1043mm
Group 1	691	830	Group 7	904	1,085	Width	650mm
Group 2	708	850	Leather 1	812	975	Depth	600mm
Group 3	728	874	Leather 2	886	1,064	Seat height	750mm
Group 4	741	890	Leather 3	959	1,151	Weight	16kg
Group 5	766	920					

Product information

Show-wood beech shell as standard
 Upholstered inner
 CMHR foam
 Seat and back veneer formed ply
 outers or double upholstery
 Tubular steel frame

Certification

Wire frame chair BS EN 15373: 2007

Special options

	£	€
Walnut veneer show-wood shell, add	104	125
Oak veneer show-wood shell, add	67	81
Other show-wood	POA	
Swivel base (MHA3G, MHC1C, MHC3C)	45	54
Chrome frame/column/base	POA	
MHA3C, MHC3A, MHC1A		
white frame	FOC	

Finishes

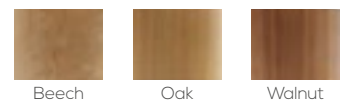

Design by David Fox Design

Product Code: TGLC/SQLO700**Description: Coffee table, squarial veneer top, silver column, 4 star polished aluminium raised base**

	£	€	Dimensions	
Price	449	539	Height	400mm
			Width	700mm
			Depth	700mm
			Weight	10kg

**Product Code: TGLD/SQLO700****Description: Dining table, squarial veneer top, silver column, 4 star polished aluminium raised base**

	£	€	Dimensions	
Price	453	544	Height	720mm
			Width	700mm
			Depth	700mm
			Weight	11kg

**Product Code: TGLP/SQLO700****Description: Poser table, squarial veneer top, silver column, 4 star polished aluminium raised base**

	£	€	Dimensions	
Price	458	550	Height	1060mm
			Width	700mm
			Depth	700mm
			Weight	13kg

**Product information**

Tables supplied unassembled
 25mm veneer top in beech,
 walnut or oak finishes
 Reverse chamfered edge

Product Code: SXL1
Description: Bench



	£	€
Group 0	830	996
Group 1	847	1,017
Group 2	885	1,062
Group 3	940	1,128
Group 4	956	1,148
Group 5	1,007	1,209
Group 6	1,166	1,400
Group 7	1,326	1,592

Dimensions

Height	800mm
Width	700mm
Depth	670mm
Seat height	475mm
Weight	8kg

Product Code: SXL2
Description: Sofa



	£	€
Group 0	1,326	1,592
Group 1	1,360	1,632
Group 2	1,439	1,727
Group 3	1,586	1,904
Group 4	1,645	1,974
Group 5	1,750	2,100
Group 6	2,124	2,549
Group 7	2,515	3,018

Dimensions

Height	800mm
Width	700mm
Depth	670mm
Seat height	475mm
Weight	10kg

Product Code: TXL1
Description: Integral table



	£	€
Group 0	539	647
Group 1	548	658
Group 2	564	677
Group 3	590	708
Group 4	602	723
Group 5	623	748
Group 6	699	839
Group 7	779	935

Dimensions

Height	800mm
Width	700mm
Depth	670mm
Seat height	475mm
Weight	13kg

Product Code: SXL3
Description: Stool



	£	€
Group 0	259	311
Group 1	267	321
Group 2	289	347
Group 3	312	375
Group 4	324	389
Group 5	345	414
Group 6	419	503
Group 7	500	600

Dimensions

Height	800mm
Width	700mm
Depth	670mm
Seat height	475mm
Weight	13kg

Product information

CMHR foam
 Hardwood substructure
 Silver mild steel tubular frame

Special options

Chrome frame POA
 Dual upholstery POA
 White frame FOC



Horizon Fabric Matrix

Design by Roger Webb Associates

Fabric Options

Choosing your fabric for Horizon

To ensure optimum quality of your finished product, see the list of our recommended fabrics below.

When we receive your order we will check with our suppliers that the chosen fabric is in stock, then advise you of a suitable delivery time.

Please note: Not all of our standard fabrics, vinyls and leather are suitable for all of our products.

Quality and colour finishes on fabric are as per the fabric supplier's standards, therefore any issues relating to this fall outside of Connection's warranty and quality measurements.

Where a customer is supplying their own fabric, and the fabric does not appear in the above list, the following shall apply:

- £150 patterning charge to cover creating templates.
- A quantity of fabric must be supplied to Connection to facilitate creating new templates - 5m per soft seating product, 2m per task/meeting product. For larger sofas a greater quantity may be required. This fabric will be used in the templating/design process.
- Once the fabric is approved, the order will be processed on standard lead time (starting from the date of approval).
- In the event that the fabric is deemed unsuitable for the requested product, the patterning charge will be refundable.

Group 3	
Supplier	Range
Abbotsford	Feast
Camira	Blazer
Camira	Halcyon
Camira	High-Tech
Camira	Intervene
Camira	Marvel
Camira	24/7+
Connection	Syntec V
Gabriel	Europost
Gabriel	Gaja
Moon	Earth
Moon	Spectrum
Spectrum	Colour Palette Vinyl V
Vescom	Furka Plus V

Group 4	
Supplier	Range
Camira	Blazer Check
Camira	Monroe
Camira	Timeline
Vescom	Keri V
Vescom	Cyprus V
Vescom	Leone Plus V
Vescom	Malta V
Vescom	Dodan V
Vescom	Sanak V
Vescom	Brant V

Group 5	
Supplier	Range
Camira	Adrenaline
Camira	Monochrome Stripe Plus
Camira	Pinstripe Plus
Camira	Smarty Plus
Camira	Sting Plus
Camira	Stripes 2 Plus
Chieftain	Multi Stretch V
Gabriel	Code
Kvadrat	Messenger V
Kvadrat	Scuba V
Yarwood Synthetic	Batani V
Yarwood Synthetic	Natur V
Vescom	Ambu
Vescom	Lindau
Vescom	Hestan
Vescom	Ponza

Group 6	
Supplier	Range
Bute	Elgin
Bute	Kames
Bute	Tiree
Bute	Troon
Bute	Turnberry
Gabriel	Arlanda
Gabriel	Blake
Gabriel	Comfort 8580
Gabriel	Luna
Kvadrat	Divina 3
Kvadrat	Divina Melange 2
Kvadrat	Flora 2
Kvadrat	Hallingdal 65
Kvadrat	Steelcut
Kvadrat	Willow
Vescom	Yuma
Vescom	Bowen
Vescom	Lani
Vescom	Keros

V indicates vinyl



Horizon

Design by Roger Webb Associates



Product Code: SHZ1
Description: Right-hand wave bench

	£	€	Dimensions	
Group 3	1,521	1,826	Height	730mm
Group 4	1,588	1,906	Width	1200mm
Group 5	1,721	2,066	Depth	980mm
Group 6	2,289	2,747	Seat height	400mm
Group 7	2,523	3,028	Weight	44kg



Product Code: SHZ2
Description: Left-hand wave bench

	£	€	Dimensions	
Group 3	1,521	1,826	Height	730mm
Group 4	1,588	1,906	Width	1200mm
Group 5	1,721	2,066	Depth	980mm
Group 6	2,289	2,747	Seat height	400mm
Group 7	2,523	3,028	Weight	44kg

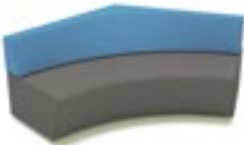

Product Code: SHZ5
Description: 120° 1200 bench

	£	€	Dimensions	
Group 3	2,412	2,895	Height	730mm
Group 4	2,511	3,014	Width	2075mm
Group 5	2,688	3,226	Depth	1182mm
Group 6	3,328	3,994	Seat height	400mm
Group 7	4,021	4,826	Weight	55kg

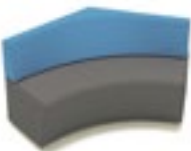

Product Code: SHZ6
Description: 120° 900 bench

	£	€	Dimensions	
Group 3	1,888	2,266	Height	730mm
Group 4	1,971	2,366	Width	1560mm
Group 5	2,120	2,544	Depth	1040mm
Group 6	2,659	3,191	Seat height	400mm
Group 7	3,600	4,320	Weight	46kg

Product information
Plywood frame
CMHR foam
Modular system linked in situ with fixing clips

Please note
Please supply layout drawings with your order

Horizon

Design by Roger Webb Associates

Product Code: SHZ11
Description: 90° bench

	£	€
Group 3	1,818	2,182
Group 4	1,901	2,282
Group 5	2,050	2,460
Group 6	2,589	3,107
Group 7	3,530	4,236

Dimensions

Height	730mm
Width	1200mm
Depth	1200mm
Seat height	400mm
Weight	47kg

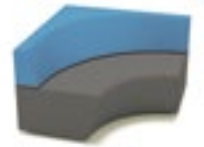

Product Code: SHZ10
Description: Large D-end bench

	£	€
Group 3	2,128	2,554
Group 4	2,222	2,667
Group 5	2,393	2,872
Group 6	3,011	3,614
Group 7	3,671	4,406

Dimensions

Height	730mm
Width	1900mm
Depth	980mm
Seat height	400mm
Weight	45kg



Product Code: SHZ9
Description: Small D-end bench

	£	€
Group 3	1,149	1,379
Group 4	1,194	1,433
Group 5	1,284	1,541
Group 6	1,662	1,995
Group 7	1,817	2,181

Dimensions

Height	730mm
Width	1360mm
Depth	680mm
Seat height	400mm
Weight	38kg

**Product information**

Plywood frame
 CMHR foam
 Modular system linked in situ with
 fixing clips

Please note

Please supply layout drawings with
 your order



Horizon

Example Configurations

Design by Roger Webb Associates

Triform



Modules

3 x SHZ10, 3 x SHZ5.

3 x SHZ1, 3 x SHZ2

Group 3 £22,746

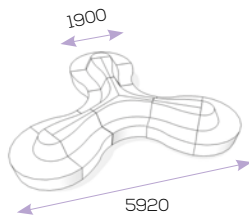

Island



Modules

1 x SHZ1, 1 x SHZ2,

1 x SHZ10, 1 x SHZ9

Group 3 £6,319

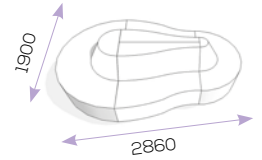

Wave



Modules

2 x SHZ11, 2 x SHZ1,

2 x SHZ2

Group 3 £9,720

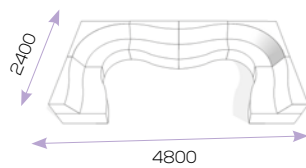

Quadrant



Modules

4 x SHZ10, 4 x SHZ11,

4 x SHZ1, 4 x SHZ2

Group 3 £27,952

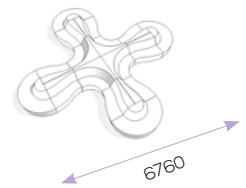

L-shape



Modules

1 x SHZ1, 1 x SHZ2, 1 x SHZ11

Group 3 £4,860

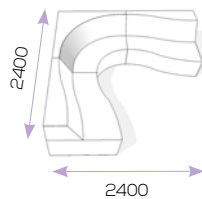

Circle



Modules

2 x SHZ9

Group 3 £2,298

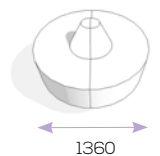

Design by David Fox Design

Product Code: SKL1A**Description: High back armchair with silver wire frame**

	£	€		£	€	Dimensions	
Group 0	838	1,006	Group 6	1,357	1,629	Height	898mm
Group 1	863	1,036	Group 7	1,474	1,769	Width	729mm
Group 2	912	1,095	Leather 1	1,213	1,456	Depth	780mm
Group 3	972	1,167	Leather 2	1,421	1,706	Seat height	400mm
Group 4	1,005	1,206	Leather 3	1,629	1,955	Weight	17kg
Group 5	1,071	1,286					

**Product Code: SKL1C****Description: High back armchair with silver 4 star swivel base**

	£	€		£	€	Dimensions	
Group 0	957	1,149	Group 6	1,468	1,762	Height	898mm
Group 1	981	1,178	Group 7	1,583	1,900	Width	729mm
Group 2	1,032	1,239	Leather 1	1,328	1,594	Depth	780mm
Group 3	1,088	1,306	Leather 2	1,531	1,838	Seat height	400mm
Group 4	1,122	1,347	Leather 3	1,734	2,081	Weight	20kg
Group 5	1,187	1,425					

**Product Code: SKL2A****Description: Armchair with silver wire frame**

	£	€		£	€	Dimensions	
Group 0	785	942	Group 6	1,175	1,410	Height	740mm
Group 1	810	972	Group 7	1,264	1,517	Width	751mm
Group 2	842	1,011	Leather 1	1,087	1,305	Depth	695mm
Group 3	886	1,064	Leather 2	1,243	1,492	Seat height	400mm
Group 4	911	1,094	Leather 3	1,399	1,679	Weight	17kg
Group 5	961	1,154					

**Product Code: SKL2C****Description: Armchair with swivel 4 star silver base**

	£	€		£	€	Dimensions	
Group 0	929	1,115	Group 6	1,320	1,584	Height	740mm
Group 1	954	1,145	Group 7	1,408	1,690	Width	751mm
Group 2	986	1,184	Leather 1	1,232	1,479	Depth	695mm
Group 3	1,030	1,236	Leather 2	1,387	1,665	Seat height	400mm
Group 4	1,055	1,266	Leather 3	1,543	1,852	Weight	20kg
Group 5	1,106	1,328					

**Product information**

Cold cured moulded foam
Steel wire frame
SKL1c, skl2c 4 star silver steel base

Certification

BS4875: 2001
BS EN 1022: 2005

Special options

Dual upholstery, add (per unit)
5 or more
Chrome steel base/wire frame
White frame/base

	£	€
Dual upholstery, add (per unit)	42	51
5 or more	FOC	
Chrome steel base/wire frame	POA	
White frame/base	FOC	



Kala

Design by David Fox Design

**Product Code: SKL1G****Description: High back armchair with solid oak base (for complementary tables see p 143)**

	£	€		£	€	Dimensions	
Group 0	1,055	1,266	Group 6	1,574	1,889	Height	898mm
Group 1	1,088	1,306	Group 7	1,691	2,030	Width	729mm
Group 2	1,130	1,356	Leather 1	1,457	1,749	Depth	780mm
Group 3	1,189	1,427	Leather 2	1,664	1,997	Seat height	400mm
Group 4	1,222	1,467	Leather 3	1,871	2,246	Weight	16kg
Group 5	1,289	1,547					

**Product Code: SKL2G****Description: Armchair with solid oak base (for complementary tables see p 143)**

	£	€		£	€	Dimensions	
Group 0	969	1,163	Group 6	1,489	1,787	Height	740mm
Group 1	1,003	1,204	Group 7	1,606	1,928	Width	751mm
Group 2	1,045	1,254	Leather 1	1,371	1,646	Depth	695mm
Group 3	1,103	1,324	Leather 2	1,578	1,894	Seat height	400mm
Group 4	1,137	1,365	Leather 3	1,785	2,142	Weight	14kg
Group 5	1,204	1,445					

**Product Code: TKAC/SQL0750WHM/SIWI (White), TKAC/SQL0750WAM/SIWI (Walnut)****Description: Squarial top coffee table, silver wire frame**

	£	€	Dimensions	
White/ walnut	249	299	Height	400mm
			Width	750mm
			Depth	750mm
			Weight	10/15kg

**Product Code: TKAC/SQL0750WHM/SI4S (White), TKAC/SQL0750WAM/SI4S (Walnut)****Description: Squarial top coffee table, 4 star base**

	£	€	Dimensions	
White/ walnut	326	392	Height	400mm
			Width	750mm
			Depth	750mm
			Weight	15/19kg

Product informationCold cured moulded foam
Solid oak base**Special options**Dual upholstery, add (per unit) £ 42 € 51
5 or more FOC
Other wood finishes available POA**Table information**Tables supplied unassembled
18mm MFC top ABS edging
Other table top finishes available subject to minimum quantity POA**Special options**Chrome base POA
TKAC white frame FOC

Design by David Fox Design

Product Code: SKO1E**Description: Armchair with silver 4 leg frame**

	£	€		£	€	Dimensions	
Group 0	639	767	Group 6	986	1,184	Height	840mm
Group 1	652	783	Group 7	1,064	1,277	Width	634mm
Group 2	686	824	Leather 1	888	1,066	Depth	661mm
Group 3	726	872	Leather 2	1,028	1,234	Seat height	460mm
Group 4	748	898	Leather 3	1,166	1,400	Weight	11kg
Group 5	793	952					

**Product Code: SKO1H****Description: Armchair with silver wire frame**

	£	€		£	€	Dimensions	
Group 0	675	810	Group 6	1,017	1,221	Height	840mm
Group 1	687	825	Group 7	1,095	1,314	Width	634mm
Group 2	725	870	Leather 1	922	1,107	Depth	640mm
Group 3	763	916	Leather 2	1,059	1,271	Seat height	460mm
Group 4	785	942	Leather 3	1,195	1,434	Weight	12kg
Group 5	830	996					

**Product Code: SKO1I****Description: Armchair with silver cantilever frame**

	£	€		£	€	Dimensions	
Group 0	547	657	Group 6	840	1,008	Height	810mm
Group 1	558	670	Group 7	906	1,088	Width	634mm
Group 2	586	704	Leather 1	758	910	Depth	634mm
Group 3	619	743	Leather 2	877	1,053	Seat height	460mm
Group 4	638	766	Leather 3	995	1,194	Weight	13kg
Group 5	677	813					

**Product Code: SKO1K****Description: Armchair with fixed silver column, 4 star polished aluminium raised base**

	£	€		£	€	Dimensions	
Group 0	751	902	Group 6	1,082	1,299	Height	864mm
Group 1	767	921	Group 7	1,156	1,388	Width	634mm
Group 2	800	960	Leather 1	990	1,188	Depth	634mm
Group 3	836	1,004	Leather 2	1,122	1,347	Seat height	460mm
Group 4	858	1,030	Leather 3	1,255	1,506	Weight	12kg
Group 5	900	1,080					

**Product information**

Cold cured moulded foam
Steel underframes
SKO1K fixed polished aluminium
4 star base

Special options

Dual upholstery, add (per unit)	42	51
5 or more	FOC	
SKO1K swivel base	45	54
Chrome base	POA	
White frame	FOC	

Certification

SKO1E BS EN 1573: 2007



Korus

Design by David Fox Design



Product Code: SKOIO
Description: Armchair with oak base

	£	€		£	€	Dimensions	
Group 0	875	1,050	Group 6	1,147	1,377	Height	840mm
Group 1	893	1,072	Group 7	1,208	1,450	Width	634mm
Group 2	915	1,098	Leather 1	1,085	1,302	Depth	661mm
Group 3	945	1,134	Leather 2	1,194	1,433	Seat height	460mm
Group 4	963	1,156	Leather 3	1,302	1,563	Weight	15kg
Group 5	998	1,198					



Product Code: TKAC/SQL0750WHM/SIWI (White), TKAC/SQL0750WAM/SIWI (Walnut)
Description: Squarial top coffee table, silver wire frame

	£	€	Dimensions	
White/ walnut	249	299	Height	400mm
			Width	750mm
			Depth	750mm
			Weight	10/15kg



Product Code: TKAC/SQL0750WHM/SI4S (White), TKAC/SQL0750WAM/SI4S (Walnut)
Description: Squarial top coffee table, 4 star base

	£	€	Dimensions	
White/ walnut	326	392	Height	400mm
			Width	750mm
			Depth	750mm
			Weight	15/19kg

Product information

Cold cured moulded foam
 Steel underframes
 Solid wood base

Special options

	£	€
Dual upholstery, add (per unit)	42	51
5 or more	FOC	
Other wood finishes available	POA	

Table information

Tables supplied unassembled
 18mm MFC top ABS edging
 Other table top finishes available subject to minimum quantity POA

Table special options

Chrome base	POA
TKAC white frame	FOC

Product Code: SME1A

Description: High back armchair with silver 4 star swivel base

	£	€
Group 3	1,253	1,504
Group 4	1,282	1,539
Group 5	1,341	1,610
Group 6	1,591	1,910
Group 7	1,695	2,034

Dimensions

Height	1160mm
Width	770mm
Depth	740mm
Seat height	430mm
Weight	26kg

**Product Code: SME2A**

Description: Medium back armchair with silver 4 star swivel base

	£	€		£	€
Group 3	1,085	1,302	Leather 1	1,292	1,551
Group 4	1,111	1,334	Leather 2	1,451	1,742
Group 5	1,163	1,396	Leather 3	1,610	1,932
Group 6	1,382	1,659			
Group 7	1,472	1,767			

Dimensions

Height	910mm
Width	770mm
Depth	740mm
Seat height	430mm
Weight	24kg

**Product Code: SME1D**

Description: High back armchair with silver 4 star fixed base

	£	€
Group 3	1,196	1,436
Group 4	1,226	1,472
Group 5	1,284	1,541
Group 6	1,535	1,842
Group 7	1,638	1,966

Dimensions

Height	1160mm
Width	770mm
Depth	740mm
Seat height	430mm
Weight	26kg

**Product Code: SME2D**

Description: Medium back armchair with silver 4 star fixed base

	£	€		£	€
Group 3	1,029	1,235	Leather 1	1,235	1,482
Group 4	1,054	1,265	Leather 2	1,394	1,673
Group 5	1,106	1,328	Leather 3	1,553	1,864
Group 6	1,325	1,590			
Group 7	1,415	1,698			

Dimensions

Height	910mm
Width	770mm
Depth	740mm
Seat height	430mm
Weight	24kg

**Product information**

Steel framework, moulded with cold cured polyurethane
Moulded cold cured polyurethane seat cushion
Silver 4 star swivel or fixed base

Please note: SME1A/SME1D/SME1G high back chairs are not suitable for upholstery in vinyl or leather.

Certification

BS EN 16139: 2013 Level 1

Special options

Dual upholstery, add (per unit)
5 or more
Chrome steel base
White base
Other wood leg finishes are available

	£	€
Dual upholstery, add (per unit)	42	51
5 or more	FOC	
Chrome steel base	POA	
White base	FOC	
Other wood leg finishes are available	POA	



Mae

Product Code: SME1G

Description: High back armchair with oak base

	£	€	Dimensions	
Group 3	1,212	1,455	Height	1160mm
Group 4	1,242	1,490	Width	770mm
Group 5	1,301	1,561	Depth	740mm
Group 6	1,551	1,861	Seat height	430mm
Group 7	1,654	1,985	Weight	26kg



Product Code: SME2G

Description: Medium back armchair with oak base

	£	€		£	€	Dimensions	
Group 3	1,045	1,254	Leather 1	1,251	1,501	Height	910mm
Group 4	1,1071	1,285	Leather 2	1,410	1,692	Width	770mm
Group 5	1,122	1,346	Leather 3	1,569	1,883	Depth	740mm
Group 6	1,341	1,609				Seat height	430mm
Group 7	1,431	1,717				Weight	24kg



Smith

Design by David Fox

Product Code: SM11A

Description: Chair with chrome 4 star swivel base

	£	€		£	€	Dimensions	
Group 0	913	1,096	Group 6	1,341	1,610	Height	800mm
Group 1	941	1,130	Group 7	1,438	1,726	Width	760mm
Group 2	975	1,170	Leather 1	1,274	1,529	Depth	620mm
Group 3	1,024	1,229	Leather 2	1,459	1,751	Seat height	480mm
Group 4	1,051	1,262	Leather 3	1,644	1,973	Weight	16kg
Group 5	1,106	1,328					



Product information

Steel frame with moulded
cold-cure polyurethane shell
Polished chrome 4 star swivel base

Certification

BS EN 16139: 2013 Level 1

Special options

Dual upholstery,
add (per unit)
5 or more units

£	€
42	51
FOC	

Mortimer

Design by Jones & Partners

Product Code: SMO1I**Description: Armchair with oak base**

	£	€
Group 3	994	1,193
Group 4	1,020	1,224
Group 5	1,072	1,287
Group 6	1,293	1,552
Group 7	1,384	1,661

	£	€
Leather 1	1,110	1,332
Leather 2	1,271	1,526
Leather 3	1,431	1,718

Dimensions

Height	845mm
Width	680mm
Depth	700mm
Weight	14kg

**Product Code: SMO1B****Description: Armchair with silver wire 4 leg base**

	£	€
Group 3	884	1,061
Group 4	910	1,092
Group 5	962	1,155
Group 6	1,183	1,420
Group 7	1,274	1,529

	£	€
Leather 1	990	1,188
Leather 2	1,151	1,382
Leather 3	1,311	1,574

Dimensions

Height	845mm
Width	680mm
Depth	700mm
Weight	17kg

**Product Code: SMO1H****Description: Armchair with silver fixed column base**

	£	€
Group 3	804	965
Group 4	830	996
Group 5	882	1,059
Group 6	1,103	1,324
Group 7	1,194	1,433

	£	€
Leather 1	990	1,128
Leather 2	1,151	1,322
Leather 3	1,311	1,514

Dimensions

Height	845mm
Width	680mm
Depth	700mm
Weight	15kg

**Product Code: SMO1J****Description: Armchair with silver swivel column base**

	£	€
Group 3	844	1,013
Group 4	870	1,044
Group 5	922	1,107
Group 6	1,143	1,372
Group 7	1,234	1,481

	£	€
Leather 1	990	1,188
Leather 2	1,151	1,382
Leather 3	1,311	1,574

Dimensions

Height	845mm
Width	680mm
Depth	700mm
Weight	17kg

**Product information**

Injection moulded CMHR foam
 Fixed steel sub frame
 SMO1I solid oak legs
 SMO1B silver painted wire 4 leg base
 SMO1H silver painted fixed column 4 star base
 SMO1J silver painted swivel column 4 star base

Special options

Dual upholstery, add (per unit)
 5 or more units
 SMO1I Other wood finishes available
 SMO1B /H /J White base

£	€
42	51
FOC	
POA	
FOC	

Certification

SMO1I BS EN 15373: 2007
 BS EN 1022: 2005



Mortimer

Design by Jones & Partners

Product Code: SMO2
Description: Sofa with solid oak legs



	£	€	Dimensions	
Group 3	1,877	2,253	Height	920mm
Group 4	1,978	2,374	Width	2020mm
Group 5	2,155	2,586	Depth	875mm
Group 6	2,789	3,347	Weight	72kg
Group 7	3,465	4,158		

Product Code: TMOC/RECXXGLXX/OA4L
Description: Coffee table with oak frame and oak veneer top with inset clear glass



	£	€	Dimensions	
Price	781	938	Height	385mm
			Width	1200mm
			Depth	600mm
			Weight	17kg

Product Code: TMOC/TRIXXXXXX/OA3L
Description: Triangular coffee table with oak veneer top and oak legs



	£	€	Dimensions	
Price	536	644	Height	385mm
			Width	790mm
			Depth	790mm
			Weight	11kg

Product information
 CMHR foam
 Hardwood subframe
 Solid oak legs

Special options
 Dual upholstery, add (per unit) £ 42 € 51
 5 or more units FOC
 SMO11 Other wood finishes available POA

Product information
 Tables supplied unassembled
 Oak veneer top
 Solid oak legs

Special options
 Other table top and leg finishes subject to minimum quantity POA

Mortimer

Design by Jones & Partners

Product Code: TMOC/RECXXXXXX/OA4L**Description: Coffee table with oak frame and oak veneer top**

	£	€	Dimensions	
Price	570	684	Height	385mm
			Width	1200mm
			Depth	600mm
			Weight	13kg

**Product Code: TMOC/TRISTXXWHM (White), TMOC/TRISTXXBEM (Beech), TMOC/TRISTXXWAM (Walnut)****Description: Triangular coffee table with silver wire legs**

	£	€	Dimensions	
Price	490	588	Height	425mm
			Width	790mm
			Depth	790mm
			Weight	20kg

**Product Code: TMOC/RND0660WHM (White), TMOC/RND0660BEM (Beech), TMOC/RND0660WAM (Walnut)****Description: Round coffee table with silver 4 star base**

	£	€	Dimensions	
Price	320	384	Height	440mm
			Diameter	660mm
			Weight	12kg

**Table information**

Tables supplied unassembled
 18mm MFC top ABS edging
 TMOC/REC Solid oak legs, oak veneer top
 TMOC/TRIST Silver painted wire 3 leg base,
 white, beech or walnut top
 TMOC/RND Silver painted 4 star base,
 white, beech or walnut top

Table information

TMOC/TRIST Chrome base	POA
TMOC/RND Chrome base	POA
TMOC/TRIST White base	FOC
TMOC/RND White column and base	FOC
Other table top finishes subject to minimum quantity	POA



Orbis

Design by Wolfgang C R Mezger



Product Code: SOR1
Description: Armchair

	£	€		£	€	Dimensions	
Group 0	1,028	1,234	Group 6	1,699	2,039	Height	760mm
Group 1	1,054	1,265	Group 7	1,835	2,202	Width	805mm
Group 2	1,119	1,343	Leather 1	1,748	2,098	Depth	800mm
Group 3	1,162	1,395	Leather 2	2,079	2,495	Seat height	430mm
Group 4	1,225	1,470	Leather 3	2,286	2,744	Weight	32kg
Group 5	1,333	1,600					



Product Code: SOR2
Description: 2 seat sofa

	£	€		£	€	Dimensions	
Group 0	1,495	1,794	Group 6	2,425	2,910	Height	760mm
Group 1	1,536	1,844	Group 7	2,618	3,142	Width	1510mm
Group 2	1,624	1,949	Leather 1	2,494	2,993	Depth	800mm
Group 3	1,683	2,020	Leather 2	2,993	3,592	Seat height	430mm
Group 4	1,772	2,127	Leather 3	3,290	3,948	Weight	42kg
Group 5	1,920	2,304					



Product Code: SOR3
Description: 2.5 seat sofa

	£	€		£	€	Dimensions	
Group 0	1,622	1,947	Group 6	2,729	3,275	Height	760mm
Group 1	1,668	2,002	Group 7	2,948	3,538	Width	1800mm
Group 2	1,775	2,130	Leather 1	2,808	3,370	Depth	800mm
Group 3	1,846	2,216	Leather 2	3,398	4,078	Seat height	430mm
Group 4	1,951	2,342	Leather 3	3,738	4,486	Weight	48kg
Group 5	2,127	2,553					



Product Code: SOR4
Description: 3 seat sofa

	£	€		£	€	Dimensions	
Group 0	1,711	2,054	Group 6	2,831	3,398	Height	760mm
Group 1	1,770	2,124	Group 7	3,057	3,669	Width	2100mm
Group 2	1,877	2,253	Leather 1	2,912	3,495	Depth	800mm
Group 3	1,947	2,337	Leather 2	3,552	4,263	Seat height	430mm
Group 4	2,052	2,463	Leather 3	3,906	4,688	Weight	54kg
Group 5	2,230	2,676					

Product information
Hardwood frames
Web sprung seat
CMHR foam
Chrome steel legs

Certification
BS4875 Part 1: 2001
BS EN 1022: 2005

Special options

	£	€
Dual upholstery, add (per unit)	42	51
5 or more	FOC	

Ortega

Design by David Fox Design

Product Code: SOT1
Description: Armchair

	£	€
Group 0	1,142	1,371
Group 1	1,153	1,384
Group 2	1,229	1,475
Group 3	1,315	1,578
Group 4	1,365	1,638
Group 5	1,468	1,762

	£	€
Group 6	1,896	2,276
Group 7	2,071	2,486
Leather 1	1,679	2,015
Leather 2	1,991	2,390
Leather 3	2,302	2,763

Dimensions

Height	763mm
Width	798mm
Depth	860mm
Seat height	405mm
Weight	39kg



Product Code: SOT2
Description: 2 seat sofa

	£	€
Group 0	1,640	1,968
Group 1	1,687	2,025
Group 2	1,810	2,172
Group 3	1,955	2,346
Group 4	2,165	2,598
Group 5	2,340	2,808

	£	€
Group 6	2,893	3,472
Group 7	3,181	3,818
Leather 1	2,546	3,056
Leather 2	3,050	3,660
Leather 3	3,557	4,269

Dimensions

Height	763mm
Width	2000mm
Depth	880mm
Seat height	405mm
Weight	72kg



Product Code: SOT3
Description: 2.5 seat sofa

	£	€
Group 0	1,948	2,338
Group 1	2,003	2,404
Group 2	2,146	2,576
Group 3	2,310	2,772
Group 4	2,404	2,885
Group 5	2,592	3,111

	£	€
Group 6	3,394	4,073
Group 7	3,725	4,470
Leather 1	2,993	3,592
Leather 2	3,576	4,292
Leather 3	4,158	4,990

Dimensions

Height	763mm
Width	2500mm
Depth	880mm
Seat height	405mm
Weight	90kg



Product Code: TORC/RECXXXXOAV/CHWI (Oak), TORC/RECXXXXWEV/CHWI (Wenge)
Description: Veneer coffee table

	£	€
Oak	696	836
Wenge	774	929

Dimensions

Height	300mm
Width	1200mm
Depth	600mm
Weight	25kg

**Product information**

Silver frame rail
 Hardwood frames
 Zig zag sprung seat
 CMHR foam

Table information

Chromed steel wire frame
 Other top finishes available

Special options

Chrome EPC rail POA



Swoosh

Design by Roger Webb Associates

**Product Code: MSW1A****Description: Low back meeting chair, white or silver wire base**

	£	€		£	€	Dimensions	
Group 0	397	477	Group 6	742	890	Height	835mm
Group 1	411	493	Group 7	801	962	Width	500mm
Group 2	429	515	Leather 1	601	721	Depth	630mm
Group 3	454	544	Leather 2	706	847	Seat height	455mm
Group 4	468	561	Leather 3	811	973	Weight	11kg
Group 5	597	717					

**Product Code: MSW2A****Description: High back meeting chair, white or silver wire base**

	£	€		£	€	Dimensions	
Group 0	408	490	Group 6	755	906	Height	950mm
Group 1	422	507	Group 7	815	978	Width	500mm
Group 2	440	528	Leather 1	612	734	Depth	660mm
Group 3	464	557	Leather 2	717	861	Seat height	455mm
Group 4	479	574	Leather 3	822	987	Weight	11kg
Group 5	611	733					

**Product Code: SSW1A****Description: Low back reception chair, white or silver wire base**

	£	€		£	€	Dimensions	
Group 0	443	531	Group 6	843	1,012	Height	795mm
Group 1	459	551	Group 7	913	1,096	Width	640mm
Group 2	480	576	Leather 1	683	819	Depth	690mm
Group 3	509	611	Leather 2	806	968	Seat height	420mm
Group 4	526	631	Leather 3	930	1,116	Weight	13kg
Group 5	673	808					

**Product Code: SSW2A****Description: High back reception chair, white or silver wire base**

	£	€		£	€	Dimensions	
Group 0	453	544	Group 6	856	1,027	Height	945mm
Group 1	470	564	Group 7	926	1,111	Width	640mm
Group 2	491	589	Leather 1	693	832	Depth	730mm
Group 3	520	624	Leather 2	817	980	Seat height	420mm
Group 4	536	644	Leather 3	940	1,129	Weight	15kg
Group 5	686	823					

Product information

Moulded foam over preformed plywood shell
Steel rod sled frame

Special options

Chrome frame POA

Certification

BS EN 16139:2013 Level 1

Swoosh

Design by Roger Webb Associates

Product Code: SSW3A

Description: 2 seater low back sofa, white or silver wire base

	£	€		£	€	Dimensions	
Group 0	1,102	1,322	Group 6	1,792	2,151	Height	800mm
Group 1	1,126	1,352	Group 7	1,897	2,277	Width	1410mm
Group 2	1,158	1,389	Leather 1	1,462	1,754	Depth	680mm
Group 3	1,201	1,441	Leather 2	1,647	1,976	Seat height	410mm
Group 4	1,226	1,471	Leather 3	1,832	2,199	Weight	33kg
Group 5	1,537	1,845					

**Product Code: SSW1B**

Description: Low back reception chair, white or silver column, white or polished aluminium 4 star swivel base

	£	€		£	€	Dimensions	
Group 0	455	547	Group 6	742	891	Height	795mm
Group 1	466	559	Group 7	786	943	Width	640mm
Group 2	479	575	Leather 1	605	727	Depth	690mm
Group 3	497	596	Leather 2	683	819	Seat height	420mm
Group 4	507	609	Leather 3	760	912	Weight	19kg
Group 5	636	763					

**Product Code: SSW2B**

Description: High back reception chair, white or silver column, white or polished aluminium 4 star swivel base

	£	€		£	€	Dimensions	
Group 0	472	567	Group 6	801	962	Height	945mm
Group 1	485	582	Group 7	854	1,025	Width	640mm
Group 2	500	600	Leather 1	652	783	Depth	730mm
Group 3	522	626	Leather 2	745	894	Seat height	420mm
Group 4	534	641	Leather 3	838	1,005	Weight	20kg
Group 5	674	809					

**Product information**

Silver or white 4 star swivel base



Swoosh

Design by Roger Webb Associates



Product Code: GSW1X
Description: Bar stool, white or silver wire frame base

	£	€		£	€	Dimensions	
Group 0	346	415	Group 6	587	705	Height	910mm
Group 1	355	426	Group 7	626	751	Width	460mm
Group 2	366	440	Leather 1	478	573	Depth	540mm
Group 3	382	459	Leather 2	546	655	Seat height	750mm
Group 4	391	470	Leather 3	614	737	Weight	10kg
Group 5	494	592					



Product Code: GSW2C
Description: High stool, white or silver wire frame base

	£	€		£	€	Dimensions	
Group 0	265	318	Group 6	474	569	Height	750mm
Group 1	273	328	Group 7	509	611	Width	460mm
Group 2	284	341	Leather 1	385	462	Depth	350mm
Group 3	298	358	Leather 2	447	536	Weight	8kg
Group 4	307	368	Leather 3	509	610		
Group 5	389	467					



Product Code: GSW2B
Description: Medium stool, white or silver wire frame base

	£	€		£	€	Dimensions	
Group 0	252	303	Group 6	459	551	Height	680mm
Group 1	260	313	Group 7	494	593	Width	460mm
Group 2	271	325	Leather 1	372	447	Depth	350mm
Group 3	285	342	Leather 2	434	521	Weight	8kg
Group 4	294	352	Leather 3	496	595		
Group 5	374	449					



Product Code: GSW2A
Description: Low stool, white or silver wire frame base

	£	€		£	€	Dimensions	
Group 0	244	293	Group 6	449	539	Height	500mm
Group 1	252	303	Group 7	484	581	Width	460mm
Group 2	263	315	Leather 1	364	437	Depth	350mm
Group 3	277	333	Leather 2	426	511	Weight	6kg
Group 4	285	342	Leather 3	487	585		
Group 5	364	437					

Product information
Moulded foam over preformed plywood shell
Steel rod sled frame

Special options
Chrome frame POA

Swoosh

Design by Roger Webb Associates

Product Code: TSWC/RND0660WHM/SIWI (White), TSWC/RND0660WAM/SIWI (Walnut), TSWC/RND0660GLX/SIWI (Frosted glass)
 Description: Coffee table, round top, white or silver wire base

	£	€	Dimensions	
White/walnut	259	311	Height	400mm
Frosted glass	367	441	Width	660mm
			Weight	8kg (white/walnut) 13kg (glass)



Product Code: TSWC/RND0660WHM/SI4S (White), TSWC/RND0660WAM/SI4S (Walnut), TSWC/RND0660GLX/SI4S (Frosted glass)
 Description: Coffee table, round top, white or silver column, white or polished aluminium 4 star base

	£	€	Dimensions	
White/walnut	275	330	Height	400mm
Frosted glass	362	435	Width	660mm
			Weight	11kg (white/walnut) 13kg (glass)



Product Code: TSWD/SQU0750WHM/SI4S (White), TSWD/SQU0750WAM/SI4S (Walnut)
 Description: Dining table, squaral top, white or silver column, white or polished aluminium 4 star base

	£	€	Dimensions	
White/walnut	285	342	Height	720mm
Frosted glass	-	-	Width	750mm
			Depth	750mm
			Weight	14kg



Product Code: TSWP/SQU0750WHM/SI4S (White), TSWP/SQU0750WAM/SI4S (Walnut), TSWP/SQU0650GLX/SI4S (Frosted glass)
 Description: Poser table, squaral top, white or silver column, white or polished aluminium 4 star base

	£	€	Dimensions	
White/walnut	293	352	Height	1060mm
Frosted glass	371	446	Width	750mm (glass 650)
			Depth	750mm (glass 650)
			Weight	14kg (white/walnut) 16kg (glass)

**Product information**

Tables supplied unassembled
 18mm MFC top, ABS edging
 10mm frosted safety glass
 Whilst every effort is made to ensure parity of colour on our table top finishes, the company cannot guarantee an exact match on any timber product.

Special options

Chrome frame POA

For the full selection of Swoosh tables, please see pages 130-132



Zeus

Design by David Fox Design



Product Code: SZS3A
Description: Left hand modular sofa

	£	€		£	€	Dimensions	
Group 0	1,569	1,883	Group 6	2,454	2,945	Height	760mm
Group 1	1,632	1,959	Group 7	2,881	3,458	Width	1230mm
Group 2	1,697	2,037	Leather 1	2,278	2,734	Depth	900mm
Group 3	1,867	2,241	Leather 2	2,597	3,117	Seat height	410mm
Group 4	1,926	2,312	Leather 3	2,918	3,502	Seat width	1000mm
Group 5	2,058	2,470				Weight	35kg



Product Code: SZS5A
Description: Modular sofa

	£	€		£	€	Dimensions	
Group 0	1,280	1,536	Group 6	1,916	2,300	Height	760mm
Group 1	1,323	1,588	Group 7	2,224	2,669	Width	1000mm
Group 2	1,371	1,646	Leather 1	1,781	2,138	Depth	900mm
Group 3	1,495	1,794	Leather 2	2,006	2,408	Seat height	410mm
Group 4	1,537	1,845	Leather 3	2,235	2,682	Seat width	1000mm
Group 5	1,632	1,959				Weight	27kg



Product Code: SZS4A
Description: Right hand modular sofa

	£	€		£	€	Dimensions	
Group 0	1,569	1,883	Group 6	2,454	2,945	Height	760mm
Group 1	1,632	1,959	Group 7	2,881	3,458	Width	1230mm
Group 2	1,697	2,037	Leather 1	2,278	2,734	Depth	900mm
Group 3	1,867	2,241	Leather 2	2,597	3,117	Seat height	410mm
Group 4	1,926	2,312	Leather 3	2,918	3,502	Seat width	1000mm
Group 5	2,058	2,470				Weight	35kg



Product Code: SZS1A
Description: Armchair

	£	€		£	€	Dimensions	
Group 0	1,229	1,475	Group 6	2,108	2,530	Height	760mm
Group 1	1,287	1,545	Group 7	2,534	3,041	Width	850mm
Group 2	1,350	1,620	Leather 1	1,872	2,247	Depth	870mm
Group 3	1,520	1,824	Leather 2	2,160	2,592	Seat height	410mm
Group 4	1,580	1,896	Leather 3	2,460	2,952	Seat width	600mm
Group 5	1,713	2,056				Weight	41kg

Product information
 Chrome underframe, grey nylon glides
 Hardwood subframe
 CMHR foam

Product information (opposite page)
 18mm MFC top with matching ABS edging

Special options (opposite page)
 Table:
 Chrome column POA
 White column, chrome collar,
 silver oval pedestal base POA
 Other table top and
 column finishes available POA

Zeus

Design by David Fox Design

Product Code: SZS2A
Description: Large sofa

	£	€		£	€	Dimensions	
Group 0	2,325	2,790	Group 6	4,091	4,910	Height	760mm
Group 1	2,448	2,938	Group 7	4,939	5,927	Width	2500mm
Group 2	2,576	3,092	Leather 1	3,552	4,263	Depth	900mm
Group 3	2,918	3,502	Leather 2	4,139	4,967	Seat height	410mm
Group 4	3,035	3,642	Leather 3	4,724	5,669	Seat width	1960mm
Group 5	3,301	3,962				Weight	94kg



Product Code: TZEC/OVLXXXXWHM/SIPE (Coffee table), TZED/OVLXXXXWHM/SIPE (Dining table)
Description: Oval table

	£	€	Dimensions	
Coffee table	250	300	Height	520mm (dining table 700mm)
Dining table	305	366	Width	350mm
			Depth	570mm
			Weight	13kg



Vision

Design by Roger Webb Associates

Product Code: SV11
Description: Tub chair, silver 4 leg frame

	£	€		£	€	Dimensions	
Group 0	299	359	Group 6	578	694	Height	810mm
Group 1	339	407	Group 7	631	758	Width	600mm
Group 2	368	442	Leather 1	515	618	Depth	600mm
Group 3	392	471	Leather 2	608	730	Seat height	410mm
Group 4	423	508	Leather 3	698	838	Seat width	410mm
Group 5	454	545				Weight	12kg



Product information

CMHR foam
Steel subframe

Certification

BS EN 1573: 2007

Special options

Chrome glides, add
Chrome steel base options
White frame

£	€
12	15
POA	
FOC	





Task & Meeting





Product Code: O2ISAA1

Description: Upholstered back task chair with black height adjustable back and arms, black nylon base, 60mm seat slide, standard synchronised mechanism

	£	€		£	€	Dimensions	
Group 0	401	482	Group 6	493	592	Height	1000-1120mm
Group 1	407	489	Group 7	513	616	Width	545mm
Group 2	415	498	Leather 1	472	567	Depth	Depth 400-450mm
Group 3	425	510	Leather 2	508	610	Seat height	420-540mm
Group 4	431	518	Leather 3	545	654	Weight	19kg
Group 5	443	532					



Product Code: O2ISAC1

Description: Upholstered back task chair with black height adjustable back and arms, black nylon base, 60mm seat slide, self-adjusting synchronised dual lever mechanism

	£	€		£	€	Dimensions	
Group 0	403	484	Group 6	495	594	Height	1000-1120mm
Group 1	409	491	Group 7	515	618	Width	545mm
Group 2	417	501	Leather 1	474	569	Depth	400-450mm
Group 3	427	513	Leather 2	510	612	Seat height	420-540mm
Group 4	433	520	Leather 3	547	657	Weight	19kg
Group 5	445	534					



Product Code: O2ISEE1

Description: Upholstered back draughtsman chair with black nylon draughtsman base and glides, PCB mechanism

	£	€		£	€	Dimensions	
Group 0	365	438	Group 6	456	548	Height	1270-1520mm
Group 1	371	446	Group 7	476	572	Width	600mm
Group 2	378	454	Leather 1	435	522	Depth	650mm
Group 3	388	466	Leather 2	472	567	Weight	22kg
Group 4	394	473	Leather 3	508	610		
Group 5	406	488					

Product information

Black 60mm hard wheeled castors
 Black nylon flat ergonomic base
 60mm seat slide
 Replaceable upholstered seat pad
 Ratchet back height/lumbar adjustment
 Upholstered back with black moulded plastic outer shell
 Black height adjustable arms
 Soft PU arm pads
 Gas lift tested for 24 hour use for people weighing up to 150kg (25 stone).

Certification

BS 5459 Part 2: 2000
 BS EN 1335: Part 1,2 &3

Special options

	£	€
Replacement seat cushion	92	111
Silver coloured 60mm soft wheeled castors	23	28
Polished aluminium base, polished chrome gas lift	54	65
Polished aluminium multi-adjustable arms	65	78
Head rest	96	116
Coccyx cushion	68	82
No arms	-61	-74

Draughtsman chair:

Product information

Black glides
 Black nylon flat ergonomic base
 Fixed seat
 Replaceable upholstered seat pad
 Ratchet back height/lumbar adjustment
 Upholstered back with black moulded outer shell
 Gas lift tested for 24 hour use for people weighing up to 150kg (25 stone)

Draughtsman chair:

Special options

	£	€
Chrome coloured glide	15	18
Polished aluminium base, polished chrome gas lift	68	82

Design by Roger Webb Associates

Product Code: O2ISAA2**Description: Black mesh back task chair with black height adjustable back and arms, black nylon base, 60mm seat slide, standard synchronised mechanism**

	£	€		£	€	Dimensions	
Group 0	443	532	Group 6	521	626	Height	1000-1120mm
Group 1	448	538	Group 7	538	646	Width	545mm
Group 2	454	545	Leather 1	503	604	Depth	400-450mm
Group 3	463	556	Leather 2	534	641	Seat height	420-540mm
Group 4	468	562	Leather 3	565	678	Weight	17kg
Group 5	478	574					

**Product Code: O2ISAC2****Description: Black mesh back task chair with black height adjustable back and arms, black nylon base, 60mm seat slide, self-adjusting synchronised dual lever mechanism**

	£	€		£	€	Dimensions	
Group 0	445	534	Group 6	523	628	Height	1000-1120mm
Group 1	450	540	Group 7	540	648	Width	545mm
Group 2	456	548	Leather 1	505	606	Depth	400-450mm
Group 3	465	558	Leather 2	536	644	Seat height	420-540mm
Group 4	470	564	Leather 3	567	681	Weight	17kg
Group 5	480	576					

**Product Code: O2ISEE2****Description: Black mesh back draughtsman chair with black nylon draughtsman base and glides, PCB mechanism**

	£	€		£	€	Dimensions	
Group 0	388	466	Group 6	467	561	Height	1270-1520mm
Group 1	393	472	Group 7	484	581	Width	600mm
Group 2	400	480	Leather 1	449	539	Depth	650mm
Group 3	409	491	Leather 2	480	576	Seat height	670-940mm
Group 4	414	497	Leather 3	511	614	Weight	20kg
Group 5	424	509					

**Task chair:****Product information**

Black 60mm hard wheeled castors
 Black nylon flat ergonomic base
 60mm seat slide
 Replaceable upholstered seat pad
 Ratchet back height/lumbar adjustment
 Black mesh back with black moulded plastic yoke
 Black height adjustable arms
 Soft PU arm pads
 Gas lift tested for 24 hour use for people weighing up to 150kg (25 stone)

Certification

BS 5459 Part 2: 2000
 BS EN 1335: Part 1,2 &3

Special options

Special options	£	€
Replacement seat cushion	92	111
Silver coloured 60mm soft wheeled castors	23	28
Polished aluminium base, polished chrome gas lift	54	65
Polished aluminium multi-adjustable arms	65	78
Coccyx cushion	68	82
No arms	-61	-74
Alternative mesh colours	POA	

Draughtsman chair:**Product information**

Black glides
 Black nylon flat ergonomic base
 Fixed seat
 Replaceable upholstered seat pad
 Ratchet back height/lumbar adjustment
 Black mesh back with black moulded plastic yoke
 Gas lift tested for 24 hour use for people weighing up to 150kg (25 stone)

Draughtsman chair:

Special options	£	€
Chrome coloured glide	15	18
Polished aluminium base, polished chrome gas lift	68	82
Alternative mesh colours	POA	



**Product Code: MIS2I****Description: 4 leg stacking chair, moulded backrest, silver frame**

	£	€
Group 0	214	257
Group 1	218	262
Group 2	239	287
Group 3	252	303
Group 4	260	312
Group 5	276	332

	£	€
Group 6	348	418
Group 7	376	452
Leather 1	299	359

Dimensions

Height	820mm
Width	505mm
Depth	535mm
Seat height	480mm
Weight	9kg

**Product Code: MIS5I****Description: 4 leg stacking chair, fully upholstered, silver frame**

	£	€
Group 0	259	311
Group 1	268	322
Group 2	296	356
Group 3	315	378
Group 4	330	396
Group 5	352	423

	£	€
Group 6	432	519
Group 7	469	563
Leather 1	387	465

Dimensions

Height	820mm
Width	505mm
Depth	535mm
Seat height	480mm
Weight	9kg

**Product Code: MIS2A****Description: 4 leg stacking armchair, moulded backrest, silver frame**

	£	€
Group 0	236	284
Group 1	240	288
Group 2	260	312
Group 3	275	330
Group 4	282	339
Group 5	299	359

	£	€
Group 6	370	444
Group 7	399	479
Leather 1	320	384

Dimensions

Height	820mm
Width	590mm
Depth	535mm
Seat height	480mm
Weight	10kg

Product information

Graphite back insert detail
 Black Feet
 Black arm inserts (no arms)
 Visible body components – outer seat
 back and arms black
 Cantilever/4 leg chair stacks to 4 high
 Removable seat cushion

Certification

Meeting chair (4 leg)
 BS EN 15373: 2007

Special options

	£	€
Linking device 4 leg only (specify at time of order), add	23	28
4 leg chair with castors, add	37	45
Chrome steel frame	POA	



Design by Roger Webb Associates

Product Code: MISSA**Description: 4 leg stacking armchair, fully upholstered, silver frame**

	£	€		£	€
Group 0	282	339	Group 6	455	546
Group 1	289	347	Group 7	491	590
Group 2	318	382	Leather 1	411	494
Group 3	339	407			
Group 4	352	423			
Group 5	374	449			

Dimensions

Height	820mm
Width	590mm
Depth	535mm
Seat height	480mm
Weight	10kg

**Product Code: MIS2M****Description: Cantilever stacking chair, moulded backrest, silver frame**

	£	€		£	€
Group 0	270	324	Group 6	406	488
Group 1	275	330	Group 7	434	521
Group 2	297	357	Leather 1	356	428
Group 3	310	372			
Group 4	318	382			
Group 5	332	399			

Dimensions

Height	820mm
Width	505mm
Depth	600mm
Seat height	485mm
Weight	9kg

**Product Code: MIS5M****Description: Cantilever stacking chair, fully upholstered, silver frame**

	£	€		£	€
Group 0	315	378	Group 6	492	591
Group 1	325	390	Group 7	528	634
Group 2	354	425	Leather 1	448	538
Group 3	374	449			
Group 4	388	466			
Group 5	411	494			

Dimensions

Height	820mm
Width	505mm
Depth	600mm
Seat height	485mm
Weight	9kg

**Certification**Meeting chair (cantilever)
BS EN 15373: 2007Is meeting chair (writing tablet)
BS EN 15373: 2007**Writing tablet:****Special options**Each pricing group, add
8mm white laminate top
Left or right hand, please
specify at time of order
Other finishes available
Chair with writing tablet
does not stack

£	€
98	118



Is

Design by Roger Webb Associates



Product Code: MIS2E
Description: Cantilever stacking armchair, moulded back, silver frame

	£	€		£	€
Group 0	289	347	Group 6	430	516
Group 1	294	353	Group 7	457	549
Group 2	318	382	Leather 1	380	456
Group 3	331	398			
Group 4	340	408			
Group 5	355	426			

Dimensions	
Height	820mm
Width	590mm
Depth	600mm
Seat height	485mm
Weight	10kg



Product Code: MIS5E
Description: Cantilever stacking armchair, fully upholstered, silver frame

	£	€		£	€
Group 0	338	406	Group 6	515	618
Group 1	345	414	Group 7	550	660
Group 2	375	450	Leather 1	471	566
Group 3	396	476			
Group 4	411	494			
Group 5	432	519			

Dimensions	
Height	820mm
Width	590mm
Depth	600mm
Seat height	485mm
Weight	10kg



Product Code: WRITING TABLET
Description: Chair with writing tablet (non-stacking)

Refer to information below for pricing

Dimensions	
Width	210-285mm
Depth	310mm

Certification
 Meeting chair (cantilever)
 BS EN 15373: 2007

Is meeting chair (writing tablet)
 BS EN 15373: 2007

Writing tablet:
Special options
 Each pricing group, add
 8mm white laminate top
 Left or right hand, please
 specify at time of order
 Other finishes available
 Chair with writing tablet
 does not stack

£	€
98	118



Design by Roger Webb Associates

Product code: (See below separate product codes for white finish and maple finish)
Description: Folding rectangular top meeting table with silver frame and castors

Dimensions	Product code (White)	Product code (Maple)	£	€
1200 x 600	TISRFC/1200X600WH/SI	TISRFC/1200X600MA/SI	594	713
1400 x 700	TISRFC/1400X700WH/SI	TISRFC/1400X700MA/SI	598	718
1500 x 750	TISRFC/1500X750WH/SI	TISRFC/1500X750MA/SI	598	718
1600 x 800	TISRFC/1600X800WH/SI	TISRFC/1600X800MA/SI	603	724
1800 x 900	TISRFC/1800X900WH/SI	TISRFC/1800X900MA/SI	611	734



Product code: (See below separate product codes for white finish and maple finish)
Description: Folding D-end meeting table with silver frame and castors

Dimensions	Product code (White)	Product code (Maple)	£	€
1200 x 600	-	-		
1400 x 700	TISDFC/1400X700WH/SI	TISDFC/1400X700MA/SI	598	718
1500 x 750	-	-		
1600 x 800	TISDFC/1600X800WH/SI	TISDFC/1600X800MA/SI	633	760
1800 x 900	-	-		



Product code: (See below separate product codes for white finish and maple finish)
Description: Fixed top rectangular meeting table with silver frame and glides

Dimensions	Product code (White)	Product code (Maple)	£	€
1200 x 600	-	-		
1400 x 700	-	-		
1500 x 750	-	-		
1600 x 800	TISRXC/1600X800WH/SI	TISRXC/1600X800MA/SI	473	568
1800 x 900	-	-		



Product information

Tables supplied unassembled
 Chrome cross rail as standard
 25mm MFC top, ABS edging
 Silver frame, black glides
 Folding tables are supplied without connectors

Whilst every effort is made to ensure parity of colour on our table top finishes, we cannot guarantee an exact match on any timber product

Please note

Is meeting tables can be linked together. Please add a Connector kit to your order.

Writing tablet:

Special options

Connector kit, add	£	€
Chrome frame (suffix code CH)	34	41
Integrated power module	POA	
Glides/castors (specify on order)	POA	
Other sizes and shapes/finishes available, contact Customer Service for further information	FOC	

Certification

Folding table BS EN 15372: 2008

Is Exec.

Design by Roger Webb Associates

**Product Code: MIE1****Description: Cantilever armchair, non stacking, silver frame**

	£	€		£	€	Dimensions	
Group 0	394	473	Group 6	636	764	Height	960mm
Group 1	402	483	Group 7	678	814	Width	560mm
Group 2	435	522	Leather 1	584	701	Depth	600mm
Group 3	471	566	Leather 2	659	791	Seat height	470mm
Group 4	499	599	Leather 3	733	880	Weight	14kg
Group 5	532	639					

**Product Code: OIE1AA****Description: Armchair with silver arms, black gas lift with seat tilt, swivel 4 star aluminium polished base with nylon glides**

	£	€		£	€	Dimensions	
Group 0	517	621	Group 6	766	920	Height	900-1030mm
Group 1	525	630	Group 7	808	970	Width	560mm
Group 2	554	665	Leather 1	713	856	Depth	600mm
Group 3	593	712	Leather 2	789	947	Seat height	430-560mm
Group 4	626	752	Leather 3	864	1,037	Weight	16kg
Group 5	662	795					

**Product Code: OIE1AC****Description: Armchair with silver arms, black gas lift, tension control mechanism with seat tilt, 5 star polished aluminium base and castors**

	£	€		£	€	Dimensions	
Group 0	551	662	Group 6	769	923	Height	900-1030mm
Group 1	561	674	Group 7	811	974	Width	560mm
Group 2	586	704	Leather 1	717	861	Depth	600mm
Group 3	618	742	Leather 2	792	951	Seat height	450-590mm
Group 4	641	770	Leather 3	867	1,041	Weight	18kg
Group 5	665	798					

Product information

Steel frame
 Upholstered seat and back
 on cold cured moulded foam

Certification

ME11 BS EN 15373:2007
 BS EN 1022:2005

Special options

	£	€
Chrome cantilever frame, add	56	68
OIE1AA/OIE1AC - chrome arm, add	34	41
OIE1AA/OIE1AC - polished aluminium glides, add	24	29

Design by Roger Webb Associates

Product Code: O2MYAA1**Description: Upholstered back task chair with 60mm seat slide, standard synchronised mechanism**

	£	€		£	€	Dimensions	
Group 0	338	406	Group 6	467	561	Height	1000-1200mm
Group 1	342	411	Group 7	488	586	Width	630mm
Group 2	353	424	Leather 1	439	527	Depth	530mm
Group 3	356	428	Leather 2	482	579	Seat height	470-600mm
Group 4	378	454	Leather 3	492	591	Weight	18kg
Group 5	388	466					

**Product Code: O2MYAB1****Description: Upholstered back task chair with 60mm seat slide, self-adjusting synchronised single lever mechanism**

	£	€		£	€	Dimensions	
Group 0	326	392	Group 6	410	492	Height	1000-1200mm
Group 1	331	398	Group 7	430	516	Width	630mm
Group 2	338	406	Leather 1	391	470	Depth	530mm
Group 3	348	418	Leather 2	425	510	Seat height	470-600mm
Group 4	353	424	Leather 3	459	551	Weight	18kg
Group 5	364	437					

**Product Code: O2MYBA1****Description: Upholstered back task chair with fixed seat, standard synchronised mechanism**

	£	€		£	€	Dimensions	
Group 0	310	372	Group 6	437	525	Height	1000-1200mm
Group 1	314	377	Group 7	460	552	Width	630mm
Group 2	326	392	Leather 1	410	492	Depth	530mm
Group 3	329	395	Leather 2	453	544	Seat height	470-600mm
Group 4	348	418	Leather 3	483	580	Weight	18kg
Group 5	359	431					

**Product information**

Upholstered back and seat
 Black 50mm hard wheeled castors
 Black nylon base
 Ratchet back height/lumbar adjustment.
 Black height adjustable arms
 Soft PU arm pads
 Gas lift tested for 24 hour use for people weighing up to 150kg (25 stone)

Certification

BS 5459 Part 2: 2000
 BS EN 1335: Part 1,2 & 3

Writing tablet:

Special options	£	€
Silver coloured 60mm soft wheeled castors	23	28
Polished aluminium base, polished chrome gas lift	54	65
Width adjustable arms, black levers (seat slide versions only)	11	14
Polished aluminium multi-adjustable arms (seat slide versions only)	65	78
Coccyx cushion (seat slide versions only)	68	82
No arms	-61	-74

**Product Code: O2MYBB1****Description: Upholstered back task chair with fixed seat, self-adjusting synchronised single lever mechanism**

	£	€		£	€	Dimensions	
Group 0	302	363	Group 6	386	464	Height	1000-1200mm
Group 1	307	369	Group 7	405	486	Width	630mm
Group 2	314	377	Leather 1	372	447	Depth	530mm
Group 3	324	389	Leather 2	409	491	Seat height	470-600mm
Group 4	329	395	Leather 3	445	534	Weight	18kg
Group 5	340	408					

**Product Code: O2MYBD1****Description: Upholstered back task chair with fixed seat, black nylon base, PCB mechanism**

	£	€		£	€	Dimensions	
Group 0	254	305	Group 6	380	456	Height	1000-1200mm
Group 1	258	310	Group 7	404	485	Width	630mm
Group 2	276	332	Leather 1	353	424	Depth	530mm
Group 3	286	344	Leather 2	396	476	Seat height	470-600mm
Group 4	302	363	Leather 3	410	492	Weight	19kg
Group 5	313	376					

**Product Code: O2MYEE1****Description: Upholstered back draughtsman chair with fixed seat, black nylon base and glides, PCB mechanism**

	£	€		£	€	Dimensions	
Group 0	288	346	Group 6	379	455	Height	1270-1520mm
Group 1	294	353	Group 7	400	480	Width	600mm
Group 2	301	362	Leather 1	359	431	Depth	650mm
Group 3	312	375	Leather 2	395	474	Seat height	670-940mm
Group 4	318	382	Leather 3	431	518	Weight	22kg
Group 5	329	395					

**Task chair:****Product information**

Upholstered back and seat
 Black 50mm hard wheeled castors
 Black nylon base
 Ratchet back height/lumbar adjustment.
 Black height adjustable arms
 Soft PU arm pads
 Gas lift tested for 24 hour use for people weighing up to 150kg (25 stone)

Special options	£	€
Silver coloured 60mm soft wheeled castors	23	28
Polished aluminium base, polished chrome gas lift	54	65
No arms	-61	-74

Draughtsman chair:**Product information**

Upholstered back and seat with black moulded outer
 Black glides
 Black nylon raised base
 Fixed seat
 Ratchet back height/lumbar adjustment
 Gas lift tested for 24 hour use for people weighing up to 150kg (25 stone)

Special options	£	€
Chrome coloured glide	15	18
Polished aluminium base, polished chrome gas lift	68	82

Design by Roger Webb Associates

Product Code: OMEIAAC**Description: Swivel chair, upholstered back, silver frame, black nylon base, height adjustable**

	£	€		£	€	Dimensions	
Group 0	290	348	Group 6	399	479	Height	840-960mm
Group 1	294	353	Group 7	424	509	Width	670mm
Group 2	306	368	Leather 1	371	446	Depth	570mm
Group 3	319	383	Leather 2	446	536	Seat height	440-580mm
Group 4	325	390	Leather 3	-	-	Weight	15kg
Group 5	340	408					

**Product Code: MMY1A****Description: Cantilever stacking meeting chair, upholstered back, silver frame, stackable to 4 high**

	£	€		£	€	Dimensions	
Group 0	223	268	Group 6	374	449	Height	840mm
Group 1	240	288	Group 7	398	478	Width	560mm
Group 2	263	316	Leather 1	303	364	Depth	580mm
Group 3	281	338	Leather 2	328	394	Seat height	460mm
Group 4	292	351	Leather 3	-	-	Weight	10kg
Group 5	313	376					

**Meeting chair:****Product information**Cantilever silver frame,
stackable to 4 high**Special options**

	£	€
OMEI polished base, add	45	54
Swivel armchair, chrome steel frame	POA	
Cantilever chrome steel frame	POA	
MMY1 white frame	FOC	

CertificationBS 5459 Part 2: 2000
BS EN 1335: Part 1,2 & 3
Cantilever chair BS EN 15373: 2007



Product Code: O2MYAA2

Description: Black mesh back task chair with 60mm seat slide, standard synchronised mechanism

	£	€		£	€	Dimensions	
Group 0	401	482	Group 6	479	575	Height	1000-1140mm
Group 1	405	486	Group 7	496	596	Width	630mm
Group 2	413	496	Leather 1	458	550	Depth	660mm
Group 3	423	508	Leather 2	488	586	Seat height	470-600mm
Group 4	427	513	Leather 3	503	604	Weight	15kg
Group 5	437	525					



Product Code: O2MYAB2

Description: Black mesh back task chair with 60mm seat slide, self-adjusting synchronised single lever mechanism

	£	€		£	€	Dimensions	
Group 0	400	480	Group 6	463	556	Height	1000-1140mm
Group 1	404	485	Group 7	478	574	Width	630mm
Group 2	409	491	Leather 1	449	539	Depth	660mm
Group 3	416	500	Leather 2	474	569	Seat height	470-600mm
Group 4	420	504	Leather 3	500	600	Weight	15kg
Group 5	428	514					



Product Code: O2MYBA2

Description: Black mesh back task chair with fixed seat, standard synchronised mechanism

	£	€		£	€	Dimensions	
Group 0	373	448	Group 6	452	543	Height	1000-1140mm
Group 1	377	453	Group 7	469	563	Width	630mm
Group 2	386	464	Leather 1	431	518	Depth	660mm
Group 3	395	474	Leather 2	460	552	Seat height	470-600mm
Group 4	399	479	Leather 3	475	570	Weight	15kg
Group 5	410	492					



Product Code: O2MYBB2

Description: Black mesh back task chair with fixed seat, self-adjusting synchronised single lever mechanism

	£	€		£	€	Dimensions	
Group 0	364	437	Group 6	427	513	Height	1000-1140mm
Group 1	368	442	Group 7	442	531	Width	630mm
Group 2	373	448	Leather 1	386	464	Depth	660mm
Group 3	380	456	Leather 2	401	482	Seat height	470-600mm
Group 4	384	461	Leather 3	415	498	Weight	15kg
Group 5	393	472					

Product information

Black single skin fabric mesh back
 Upholstered seat
 Black 50mm hard wheeled castors
 Black nylon base
 Black height adjustable arms
 Soft PU arm pads
 Gas lift tested for 24 hour use for people weighing up to 150kg (25 stone)

Certification

BS 5459 Part 2: 2000
 BS EN 1335: Part 1,2 &3

Special options

	£	€
Silver coloured 60mm soft wheeled castors	23	28
Polished aluminium base, polished chrome gas lift	54	65
Width adjustable arms, black levers (seat slide versions only)	11	14
Polished aluminium multi-adjustable arms (seat slide versions only)	65	78
Coccyx cushion (seat slide versions only)	68	82
No arms	-61	-74

Design by Roger Webb Associates

Product Code: O2MYEE2**Description: Black mesh back draughtsman chair with fixed seat, black nylon base and glides, PCB mechanism**

	£	€		£	€	Dimensions	
Group 0	366	440	Group 6	431	518	Height	1270-1520mm
Group 1	370	444	Group 7	446	536	Width	600mm
Group 2	375	450	Leather 1	416	500	Depth	650mm
Group 3	383	460	Leather 2	442	531	Seat height	670-940mm
Group 4	387	465	Leather 3	468	562	Weight	18kg
Group 5	395	474					

**Product Code: OME2AAC****Description: Height adjustable swivel chair with mesh back, silver frame, black nylon base**

	£	€		£	€	Dimensions	
Group 0	377	453	Group 6	488	586	Height	950-1080mm
Group 1	383	460	Group 7	512	615	Width	670mm
Group 2	394	473	Leather 1	416	500	Depth	570mm
Group 3	406	488	Leather 2	441	530	Seat height	440-580mm
Group 4	413	496	Leather 3	-	-	Weight	17kg
Group 5	427	513					

**Product Code: MMY3A****Description: Mesh back stacking meeting chair with silver cantilever frame**

	£	€		£	€	Dimensions	
Group 0	351	422	Group 6	461	554	Height	960mm
Group 1	357	429	Group 7	487	585	Width	560mm
Group 2	368	442	Leather 1	390	468	Depth	580mm
Group 3	381	458	Leather 2	416	500	Seat height	450mm
Group 4	387	465	Leather 3	-	-	Weight	12kg
Group 5	402	483					

**Draughtsman chair:****Product information**

Black single skin fabric mesh back
 Upholstered seat
 Black glides
 Black nylon raised base
 Fixed seat
 Gas lift tested for 24 hour use for people weighing up to 150kg (25 stone)

Special options	£	€
Chrome coloured glide	15	18
Polished aluminium base, Polished chrome gas lift	68	82

Certification

Mesh cantilever chair
 BS EN 15373: 2007

Meeting chair:**Product information**

Gas lift height adjustment
 Cantilever silver frame, stackable to 4 high
 Black single skin fabric mesh back

Special options	£	€
OME2 polished base, add	45	54
OME2 chrome steel frame	POA	
MMY3 chrome steel frame	POA	
MMY3 white frame	FOC	



Product code: (See below separate product codes for white finish and maple finish)
Description: Folding rectangular meeting table with silver frame and castors

Dimensions	Product code (White)	Product code (Maple)	£	€
1200 x 600	TCORFC/1200X600WH/SI	TCORFC/1200X600MA/SI	384	461
1400 x 700	TCORFC/1400X700WH/SI	TCORFC/1400X700MA/SI	384	461
1500 x 750	TCORFC/1500X750WH/SI	TCORFC/1500X750MA/SI	384	461
1600 x 800	TCORFC/1600X800WH/SI	TCORFC/1600X800MA/SI	387	465



Product code: (See below separate product codes for white finish and maple finish)
Description: Folding semi-circular meeting table with silver frame and castors

Dimensions	Product code (White)	Product code (Maple)	£	€
1200 x 600	-	-		
1400 x 700	-	-		
1500 x 750	-	-		
1600 x 800	TCOSFC/1600X800WH/SI	TCOSFC/1600X800MA/SI	415	498



Product code: (See below separate product codes for white finish and maple finish)
Description: Folding D-end meeting table with silver frame and castors

Dimensions	Product code (White)	Product code (Maple)	£	€
1200 x 600	-	-		
1400 x 700	TCODFC/1400X700WH/SI	TCODFC/1400X700MA/SI	415	498
1500 x 750	-	-		
1600 x 800	TCODFC/1600X800WH/SI	TCODFC/1600X800MA/SI	436	524

Product information

Tables supplied unassembled without connectors
 25mm MFC top, ABS edging
 Silver frame, black castors
 Tables can nest when folded
 Due to the construction of mobile tables, castors offer no height adjustability, on uneven floor surfaces the use of table connector kits is recommended.
 Whilst every effort is made to ensure parity of colour on our table top finishes, we cannot guarantee an exact match on any timber product.

Certification
 BS4875:part 5: 2001

Writing tablet:

Special options	£	€
Connector kit	34	41
Integrated power module	POA	
Chrome frame (suffix code CH instead of SI)	POA	

Other sizes and shapes/finishes available, contact Customer Services for further information

Please note

My meeting tables can be linked together. Please add a Connector kit to your order.

Design by Paul Brooks

Product Code: MONIA**Description: Armchair, 4 legs, silver frame, moulded backrest, upholstered seat, non stacking**

	£	€		£	€	Dimensions	
Group 0	228	274	Group 5	258	310	Height	830mm
Group 1	235	282	Group 6	291	350	Width	560mm
Group 2	240	288	Group 7	305	366	Depth	590mm
Group 3	247	297				Seat height	490mm
Group 4	250	300				Weight	8kg

**Product Code: MONIC****Description: Cantilever stacking armchair, silver frame, moulded backrest, upholstered seat**

	£	€		£	€	Dimensions	
Group 0	210	252	Group 5	240	288	Height	830mm
Group 1	215	258	Group 6	272	327	Width	560mm
Group 2	221	266	Group 7	286	344	Depth	590mm
Group 3	227	273				Seat height	490mm
Group 4	233	280				Weight	8kg

**Product Code: OONIAAA/AAA****Description: Armchair, 5 star black base with castors, silver frame, adjustable seat height, moulded backrest**

	£	€		£	€	Dimensions	
Group 0	245	294	Group 5	293	352	Height	830-960mm
Group 1	251	302	Group 6	327	393	Width	560mm
Group 2	262	315	Group 7	340	408	Depth	590mm
Group 3	273	328				Seat height	490-620mm
Group 4	282	339				Weight	12kg

**Product information**

Plastic body components - black as standard
Cantilever stackable to 5 high
Removable seat cushion

Certification

Meeting chair
BS EN 15373: 2007
Swivel chair
BS EN 1335 Parts 2 & 3

Special options

	£	€
White body components	28	34
OONIAAA polished		
5 star base	45	54
OONIAAA chrome steel frame	35	42
MONIA/MONIC chrome steel frame		
MONIA/MONIC white frame	POA	
OONIAAA/AAA for glides	FOC	
(specify on order (OONIAAA/AAB))		
	FOC	





Product Code: OST2AA

Description: High back office chair, 5 star polished aluminium base, zebrano or walnut plywood shell

	£	€		£	€	Dimensions	
Group 0	632	759	Group 6	1,278	1,534	Height	1190-1320mm
Group 1	664	798	Group 7	1,423	1,708	Width	580mm
Group 2	726	872	Leather 1	1,101	1,322	Depth	600mm
Group 3	799	960	Leather 2	1,358	1,630	Seat height	465-600mm
Group 4	840	1,009	Leather 3	1,614	1,938	Weight	22kg
Group 5	924	1,110					



Product Code: MST2AA

Description: Medium back visitor chair, 5 star polished aluminium base, zebrano or walnut plywood shell

	£	€		£	€	Dimensions	
Group 0	598	718	Group 6	1,081	1,298	Height	930-1060mm
Group 1	621	746	Group 7	1,191	1,430	Width	580mm
Group 2	668	802	Leather 1	948	1,138	Depth	600mm
Group 3	723	868	Leather 2	1,141	1,370	Seat height	465-600mm
Group 4	753	904	Leather 3	1,334	1,602	Weight	21kg
Group 5	816	980					



Product Code: OST8

Description: High back office chair, 5 star polished aluminium base, fully upholstered

	£	€		£	€	Dimensions	
Group 0	1,173	1,408	Group 6	2,103	2,524	Height	1190-1320mm
Group 1	1,233	1,408	Group 7	3,323	3,988	Width	580mm
Group 2	1,308	1,570	Leather 1	1,893	2,272	Depth	600mm
Group 3	1,413	1,696	Leather 2	2,264	2,717	Seat height	465-600mm
Group 4	1,473	1,768	Leather 3	2,634	3,161	Weight	22kg
Group 5	1,593	1,912					

Product information

Polished aluminium base
 CMHR foam
 Upholstered inner shell
 Available with glides or castors
 Gas lift height adjustment
 Knee tilt as standard

Please note

Whilst every effort is made to ensure parity of colour on our wood finishes, we cannot guarantee an exact match on any timber product.
 Please note: Accuracy of printed or on-screen swatches cannot be guaranteed. Please contact Customer Services for wood samples.



Walnut Zebrano

Design by Roger Webb Associates

Product Code: ORWYAA1**Description: R-Type. 60mm seat slide, self-adjusting synchronised single lever mechanism, raised base**

	£	€		£	€	Dimensions
Group 0	332	399	Group 6	397	477	Height 990-1180mm
Group 1	336	404	Group 7	412	495	Width 640mm
Group 2	341	410	Leather 1	382	459	Depth 670mm
Group 3	349	419	Leather 2	408	490	Seat height 460-590mm
Group 4	353	424	Leather 3	434	521	Weight 14kg
Group 5	361	434				

**Product Code: ORWYBA1****Description: R-Type. Fixed seat, self-adjusting synchronised single lever mechanism, raised base**

	£	€		£	€	Dimensions
Group 0	319	383	Group 6	384	461	Height 990-1180mm
Group 1	323	388	Group 7	398	478	Width 640mm
Group 2	328	394	Leather 1	369	443	Depth 670mm
Group 3	335	402	Leather 2	395	474	Seat height 460-590mm
Group 4	340	408	Leather 3	421	506	Weight 14kg
Group 5	348	418				

**Product Code: OSWYAB1****Description: S-Type. 60mm seat slide, self-adjusting synchronised dual lever mechanism, flat base**

	£	€		£	€	Dimensions
Group 0	356	428	Group 6	421	506	Height 990-1180mm
Group 1	360	432	Group 7	436	524	Width 640mm
Group 2	365	438	Leather 1	406	488	Depth 670mm
Group 3	373	448	Leather 2	432	519	Seat height 460-590mm
Group 4	377	453	Leather 3	458	550	Weight 15kg
Group 5	385	462				

**Product Code: OSWYBB1****Description: S-Type. Fixed seat, self-adjusting synchronised dual lever mechanism, flat base**

	£	€		£	€	Dimensions
Group 0	343	412	Group 6	408	490	Height 990-1180mm
Group 1	347	417	Group 7	422	507	Width 640mm
Group 2	352	423	Leather 1	393	472	Depth 670mm
Group 3	359	431	Leather 2	419	503	Seat height 460-590mm
Group 4	364	437	Leather 3	445	534	Weight 15kg
Group 5	372	447				

**R-type:****Product information**

Black 50mm hard wheeled castors
 Black nylon base
 Button operated ratchet back height/
 lumbar adjustment
 Black perforated polymer back
 Black height adjustable arms
 Soft PU arm pads
 Gas lift tested for 24 hour use for
 people weighing up to 150kg (25 stone)

Certification

Why-R BS EN 1335 Parts 2 & 3
 BS 5459
 BIFMA

R-type:**Special options**

	£	€
Replacement seat cushion	92	111
No arms	-61	-74

S-type:**Product information (opposite page)**

Black 60mm hard wheeled castors
 Black nylon base
 Button operated ratchet back height/
 lumbar adjustment
 Perforated polymer back in black,
 white or grey
 Black height adjustable arms
 Soft PU arm pads
 Gas lift tested for 24 hour use for
 people weighing up to 150kg (25 stone)

S-type:**Special options**

	£	€
Silver coloured 60mm soft wheeled castors	23	28
Polished aluminium base, polished chrome gas lift	54	65
Polished aluminium multi- adjustable arms	55	66
Width adjustable arms, black levers (seat slide versions only)	11	14
Coccyx cushion (seat slide versions only)	68	82
Replacement seat cushion	92	111
No arms	-61	-74

Xpresso.one



Product Code: MXP1A/HF
Description: High density stacking chair, upholstered seat and back

	£	€		£	€	Dimensions	
Group 0	181	218	Group 6	352	423	Height	830mm
Group 1	187	225	Group 7	392	471	Width	580mm
Group 2	204	245				Depth	490mm
Group 3	225	270				Seat height	460mm
Group 4	235	282				Seat depth	425mm
Group 5	258	310				Weight	10kg



Product Code: MXP1C/HF
Description: High density stacking chair, black arms, upholstered seat and back

	£	€		£	€	Dimensions	
Group 0	261	314	Group 6	433	520	Height	830mm
Group 1	268	322	Group 7	472	567	Width	595mm
Group 2	284	341				Depth	490mm
Group 3	305	366				Seat height	460mm
Group 4	315	378				Seat depth	425mm
Group 5	338	406				Weight	12kg











Product Code: GXPIA/AA (Black), GXPIA/BB (White), GXPIA/CC (Red), GXPIA/DD (Green), GXPIA/II (Grey), GXPIA/JJ (Light blue), GXPIA/KK (Yellow), GXPIA/LL (Purple), GXPIA/MM (Stone)
Description: Stacking stool, polypropylene seat and back

	£	€	Dimensions		Colours							
All colours	160	192	Height	1070mm								
			Width	600mm								
			Depth	490mm								
			Seat height	720mm								
			Seat depth	425mm								
			Weight	8kg								



Product Code: WRITING TABLET
Description: Writing tablet, available for all chair finishes. (Refer to information below for pricing)

Dimensions		Colours						
Width	100-305mm							
Depth	245-500mm							

Writing tablet:

Special options	£	€
Available in all chair finishes	126	152
Trolley to hold 40 tablets	720	864

Please specify right or left hand
 Other finishes available
 Chair non stacking with writing tablet

Product Code: MXP1A/AA (Black), MXP1A/BB (White), MXP1A/CC (Red), MXP1A/DD (Green), MXP1A/II (Grey), MXP1A/JJ (Light blue), MXP1A/KK (Yellow), MXP1A/LL (Purple), MXP1A/MM (Stone)

Description: High density stacking chair, polypropylene seat and back

	£	€	Dimensions
All colours	124	149	
			Height 830mm
			Width 580mm
			Depth 490mm
			Seat height 460mm
			Seat depth 425mm
			Weight 5kg

Colours



Product Code: MXP1c/AA (Black), MXP1c/BB (White), MXP1c/CC (Red), MXP1c/DD (Green), MXP1c/II (Grey), MXP1c/JJ (Light blue), MXP1c/KK (Yellow), MXP1c/LL (Purple), MXP1c/MM (Stone)

Description: High density stacking chair, black arms, polypropylene seat and back

	£	€	Dimensions
All colours	201	242	
			Height 830mm
			Width 580mm
			Depth 490mm
			Seat height 460mm
			Seat depth 425mm
			Weight 7kg

Colours



Product Code: MXP1A/AF (Black), MXP1A/BF (White), MXP1A/CF (Red), MXP1A/DF (Green), MXP1A/IF (Grey), MXP1A/JF (Light blue), MXP1A/KF (Yellow), MXP1A/LF (Purple), MXP1A/MF (Stone)

Description: High density stacking chair, polypropylene back, upholstered seat

	£	€	Dimensions
Group 0	158	190	
Group 1	161	194	
Group 2	171	206	
Group 3	182	219	
Group 4	187	225	
Group 5	200	240	
Group 6	249	299	
Group 7	270	324	

Colours



Product Code: MXP1c/AF (Black), MXP1c/BF (White), MXP1c/CF (Red), MXP1c/DF (Green), MXP1c/IF (Grey), MXP1c/JF (Light blue), MXP1c/KF (Yellow), MXP1c/LF (Purple), MXP1c/MF (Stone)

Description: High density stacking chair, black arms, polypropylene back, upholstered seat

	£	€	Dimensions
Group 0	238	286	
Group 1	241	290	
Group 2	251	302	
Group 3	262	315	
Group 4	268	322	
Group 5	280	336	
Group 6	329	395	
Group 7	350	420	

Colours



Product information

Polypropylene fibreglass backrest
Tubular chrome steel frame
Nylon glides
Chairs stackable to 10 high, trolley enables stacking to 45 high or 30 high if upholstered
Stool stacks to 5 high
MXP1A/HF, MXP1c/HF, Xpresso cannot be fully upholstered in vinyl fabric

Certification

BS EN 15373: 2007

Special options

	£	€
Linking feet (LXP)	FOC	
Trolley code (MXP)	491	590

Trolley dimensions (mm)

Height 570mm, Width 660mm
Depth 760mm, Height stacked with 45 chairs 2200mm

Please note

Accuracy of printed colours cannot be guaranteed. Please contact Customer Services for colour samples.



Xpresso.three



Product Code: MXP1A/NA (Black), MXP1A/OB (White), MXP1A/PC (Red), MXP1A/QD (Green), MXP1A/SI (Grey), MXP1A/TJ (Light blue), MXP1A/UK (Yellow), MXP1A/VL (Purple), MXP1A/WM (Stone)

Description: High density perforated back stacking chair, polypropylene seat and back

	£	€
All colours	124	129

Dimensions	
Height	830mm
Width	580mm
Depth	490mm
Seat height	460mm
Seat depth	425mm
Weight	5kg

Colours



Product Code: MXP1C/NA (Black), MXP1C/OB (White), MXP1C/PC (Red), MXP1C/QD (Green), MXP1C/SI (Grey), MXP1C/TJ (Light blue), MXP1C/UK (Yellow), MXP1C/VL (Purple), MXP1C/WM (Stone)

Description: High density perforated back stacking chair, black arms, polypropylene seat and back

	£	€
All colours	201	242

Dimensions	
Height	830mm
Width	595mm
Depth	490mm
Seat height	460mm
Seat depth	425mm
Weight	7kg

Colours



Product Code: MXP1A/NF (Black), MXP1A/OF (White), MXP1A/PF (Red), MXP1A/QF (Green), MXP1A/SF (Grey), MXP1A/TF (Light blue), MXP1A/UF (Yellow), MXP1A/VF (Purple), MXP1A/WF (Stone)

Description: High density perforated back stacking chair, upholstered seat, polypropylene back

	£	€
Group 0	158	190
Group 1	161	194
Group 2	171	206
Group 3	182	219
Group 4	187	225
Group 5	200	240
Group 6	249	299
Group 7	270	324

Dimensions	
Height	830mm
Width	580mm
Depth	490mm
Seat height	460mm
Seat depth	425mm
Weight	8kg

Colours



Product Code: MXP1C/NF (Black), MXP1C/OF (White), MXP1C/PF (Red), MXP1C/QF (Green), MXP1C/SF (Grey), MXP1C/TF (Light blue), MXP1C/UF (Yellow), MXP1C/VF (Purple), MXP1C/WF (Stone)

Description: High density perforated back stacking chair, black arms, upholstered seat, polypropylene back

	£	€
Group 0	238	286
Group 1	241	290
Group 2	251	302
Group 3	262	315
Group 4	268	322
Group 5	280	336
Group 6	329	395
Group 7	350	420

Dimensions	
Height	830mm
Width	595mm
Depth	490mm
Seat height	460mm
Seat depth	425mm
Weight	10kg

Colours

Xpresso.three

Product Code: GXPIA/NA (Black), GXPIA/OB (White), GXPIA/PC (Red), GXPIA/QD (Green), GXPIA/SI (Grey), GXPIA/TJ (Light blue), GXPIA/UK (Yellow), GXPIA/VL (Purple), GXPIA/WM (Stone)

Description: High density perforated back stacking stool polypropylene seat and back

	£	€
All colours	160	192

Dimensions	
Height	1070mm
Width	600mm
Depth	490mm
Seat height	720mm
Seat depth	425mm
Weight	8kg

Colours



Product information

Polypropylene fibreglass seat and backrest
Tubular chrome steel frame
Nylon glides
Chairs stackable to 10 high, trolley enables stacking to 45 high. Stool stacks to 5 high

Special options

	£	€
Linking feet (LXP)	FOC	
Trolley code (MXP)	491	590

Please note

Accuracy of printed colours cannot be guaranteed. Please contact Customer Services for colour samples.

Certification

BS EN 15373: 2007

Task & Meeting chairs and tables

Team

Design by Roger Webb Associates

Product Code: MTE1A

Description: Cantilever stacking armchair, silver frame

	£	€
Group 0	244	293
Group 1	252	303
Group 2	263	316
Group 3	276	332
Group 4	284	341

	£	€
Group 5	300	360
Group 6	364	437
Group 7	390	468

Dimensions

Height	890mm
Width	555mm
Depth	540mm
Seat height	460mm
Seat width	470mm
Seat depth	440mm
Weight	8kg



Product information

Stackable to 4 high, tubular steel frame

Special options

	£	€
Chrome steel frame	POA	
Trolley, add	279	335

Certification

BS4875:part 1: 2001
BS7945 1999



Café





Cookie



Product Code: MCK1/A (White), MCK1/B (Red), MCK1/C (Black), MCK1/D (Transparent)
Description: Chair, transparent or solid shell with chrome spider base

Price	£	€	Dimensions	Colours
	370	444		
			Height	830mm
			Width	615mm
			Depth	583mm
			Seat height	440mm
			Weight	11kg

Colours



Product Code: MCK2/A (White), MCK2/B (Red), MCK2/C (Black), MCK2/D (Transparent)
Description: Chair, transparent or solid shell with die-cast polished aluminium swivel base

Price	£	€	Dimensions	Colours
	405	486		
			Height	802mm
			Width	615mm
			Depth	570mm
			Seat height	440mm
			Weight	12kg

Colours



Product Code: MCK3/A (White), MCK3/B (Red), MCK3/C (Black), MCK3/D (Transparent)
Description: Chair, transparent or solid shell with die-cast aluminium self-coloured swivel base

Price	£	€	Dimensions	Colours
	485	582		
			Height	802mm
			Width	615mm
			Depth	570mm
			Seat height	440mm
			Weight	12kg

Colours



Product Code: MCK4/A (White), MCK4/B (Red), MCK4/C (Black), MCK4/D (Transparent)
Description: Chair, transparent or solid shell with solid beech 4 leg base

Price	£	€	Dimensions	Colours
	395	474		
			Height	822mm
			Width	615mm
			Depth	569mm
			Seat height	440mm
			Weight	10kg

Colours



Product information







Chair with injection moulded polycarbonate shell.

4 solid beech legs
4 star swivel base in polished and painted aluminium
Spider base in chromium-plated rod steel – non stackable

Drop



Product Code: MDP1/A (Black), MDP1/B (White), MDP1/C (Orange), MDP1/D (Green), MDP1/E (Sand), MDP1/F (Yellow), MDP1/G (Red)
MDP1/H (Purple), MDP1/I (Blue)

Description: Stacking chair, polypropylene, suitable for outdoor or indoor use. Available in 9 colours

Price	£	€	Dimensions		Colours						
	99	119	Height	780mm							
			Width	525mm	Black	White	Orange	Green	Sand	Yellow	
			Depth	525mm							
			Seat height	455mm	Red	Purple	Blue				
		Weight	4kg								

Product Code: TDP1/A (White), TDP1/B (Light grey), TDP1/C (Sand)



Description: Round stacking dining table, polypropylene, suitable for outdoor or indoor use. Available in white, light grey or sand.

Price	£	€	Dimensions		Colours		
	305	366	Height	718mm			
			Width	826mm	White	Sand	Light Grey
			Depth	826mm			
			Weight	13kg			



Product Code: TDP2/A (White), TDP2/B (Light grey), TDP2/C (Sand)

Description: Square stacking dining table, polypropylene, suitable for outdoor or indoor use. Available in white, light grey or sand.

Price	£	€	Dimensions		Colours		
	325	390	Height	722mm			
			Width	730mm	White	Sand	Light Grey
			Depth	730mm			
			Weight	13kg			



Product information

Chair: Polypropylene. Suitable for outdoor use, with rainwater drain-off
Stacks to 6 high

Accuracy of printed colours cannot be guaranteed. Please contact Customer Services for colour samples.

Table: Tables supplied unassembled
Polypropylene. Rubber feet



Emma



Product Code: MEM1/XXXX (Beech), MEM3/XXXX (Oak)
Description: Dining chair, solid oak or beech legs and plywood shell

	£	€	Dimensions	
Beech	390	468	Height	780mm
Oak	470	564	Width	470mm
			Depth	460mm
			Seat height	450mm
			Weight	4kg





Product Code: GEM1/XXXX (Beech), GEM3/XXXX (Oak)
Description: Bar stool, solid oak or beech legs and plywood shell

	£	€	Dimensions	
Beech	530	636	Height	898mm
Oak	630	756	Width	450mm
			Depth	465mm
			Seat height	746mm
			Weight	4kg





Product Code: TEM1/B (Beech), TEM1/A (Beech/ white top), TEM2/B (Oak), TEM2/A (Oak/ white top)
Description: Medium dining table, solid oak or beech frame with oak, beech or white veneered top

	£	€	Dimensions		Colours	
Beech	1,500	1,800	Height	762mm		
Beech/ white top	1,450	1,740	Width	1150mm	Beech	Oak
Oak	1,760	2,112	Depth	1150mm		
Oak/ white top	1,730	2,076	Weight	26kg		



Product Code: TEM3/B (Beech), TEM3/A (Beech/ white top), TEM4/B (Oak), TEM4/A (Oak/ white top)
Description: Large dining table, solid oak or beech frame with oak, beech or white veneered top

	£	€	Dimensions		Colours	
Beech	1,680	2,016	Height	762mm		
Beech/ white top	1,570	1,884	Width	1400mm	Beech	Oak
Oak	1,950	2,340	Depth	1400mm		
Oak/ white top	1,860	2,232	Weight	31kg		

Product information

Solid beech or oak legs

Table: Table supplied unassembled
Beech, oak or white veneered MDF
top Solid beech or oak legs.

Accuracy of printed colours cannot be guaranteed. Please contact Customer Services for colour samples.

Special options

All available POA, not standard finishes.



Emma

Product Code: MEM1/HXXX (Beech), MEM3/HXXX (Oak)

Description: Beech dining chair with upholstered seat pad, solid oak or beech legs and plywood shell

	£	€		£	€
Beech			Oak		
Group 0	475	570	Group 0	555	666
Group 1	481	578	Group 1	561	674
Group 2	489	587	Group 2	569	683
Group 3	500	600	Group 3	580	696
Group 4	507	609	Group 4	587	705
Group 5	519	623	Group 5	599	719
Group 6	574	689	Group 6	654	785
Group 7	596	716	Group 7	676	812
Leather 1	552	663	Leather 1	632	759
Leather 2	591	710	Leather 2	671	806
Leather 3	631	758	Leather 3	711	854

Dimensions

Height	780mm
Width	470mm
Depth	460mm
Seat height	450kg
Weight	5kg



Product Code: GEM1/HXXX (Beech), GEM3/HXXX (Oak)

Description: Beech bar stool with upholstered seat, solid oak or beech legs and plywood shell

	£	€		£	€
Beech			Oak		
Group 0	655	786	Group 0	755	906
Group 1	661	794	Group 1	761	914
Group 2	669	803	Group 2	769	923
Group 3	680	816	Group 3	780	936
Group 4	687	825	Group 4	787	945
Group 5	699	839	Group 5	799	959
Group 6	754	905	Group 6	854	1,025
Group 7	776	932	Group 7	876	1,052
Leather 1	732	879	Leather 1	832	999
Leather 2	771	926	Leather 2	871	1,046
Leather 3	811	974	Leather 3	911	1,094

Dimensions

Height	898mm
Width	450mm
Depth	465mm
Seat height	746kg
Weight	6kg



Frost



Product Code: MFR1A/AXXX
Description: Chrome 4 leg stacking chair, white

Price	£	€	Dimensions		Colours
	175	210	Height	780mm	 White
		Width	560mm		
		Depth	560mm		
		Seat height	470mm		
		Seat width	500mm		
		Weight	5kg		



Product Code: MFR1A/BXXX
Description: Chrome 4 leg stacking chair, red

Price	£	€	Dimensions		Colours
	175	210	Height	780mm	 Red
		Width	560mm		
		Depth	560mm		
		Seat height	470mm		
		Seat width	500mm		
		Weight	5kg		



Product Code: MFR1A/CXXX
Description: Chrome 4 leg stacking chair, translucent clear

Price	£	€	Dimensions		Colours
	175	210	Height	780mm	 Translucent
		Width	500mm		
		Depth	560mm		
		Seat height	470mm		
		Seat width	500mm		
		Weight	5kg		



Product Code: MFR1A/DXXX
Description: Chrome 4 leg stacking chair, translucent violet

Price	£	€	Dimensions		Colours
	175	210	Height	780mm	 Translucent violet
		Width	500mm		
		Depth	560mm		
		Seat height	470mm		
		Seat width	500mm		
		Weight	5kg		

Product information

Transparent or opaque polycarbonate one-piece shell. Chromium-plated or satin-finish steel frame, with jointed feet – stackable to 8 high.

Product Code: MNO1AA (Red), MNO1AB (Blue), MNO1AC (Green), MNO1AD (Black), MNO1AE (White), MNO1AF (Sand)
MNO1AG (Light grey)

Description: Chrome 4 leg stacking café chair

Price	£	€
	161	194

Dimensions	
Height	870mm
Width	500mm
Depth	560mm
Seat height	470mm
Seat width	430mm
Weight	6kg

Colours



Product Code: GNO1AA (Red), GNO1AB (Blue), GNO1AC (Green), GNO1AD (Black), GNO1AE (White)
GNO1AF (Sand), GNO1AG (Light grey)

Description: Chrome 4 leg bar stool

Price	£	€
	246	296

Dimensions	
Height	1200mm
Width	560mm
Depth	560mm
Seat height	735mm
Seat width	430mm
Weight	7kg

Colours



Product information

One-piece chair made of polypropylene and fibreglass using bi-injection technology.

Four leg frame made of chromium-plated round tube, jointed feet, with arms – stackable
Chair stacks to 6 high

Please note

Accuracy of printed colours cannot be guaranteed. Please contact Customer Services for colour samples.

Ice Seat standard white – colour choice refers to reverse of chair.

Mocha



Product Code: MMO1A
Description: Beech dining/meeting chair, silver frame

Price	£	€	Dimensions	Colours
	144	173	Height 775mm	 Beech
			Width 435mm	
			Depth 490mm	
			Seat height 445mm	
			Seat width 435mm	
			Weight 5kg	



Product Code: GMO1A
Description: Beech bar stool, silver frame

Price	£	€	Dimensions	Colours
	185	222	Height 980mm	 Beech
			Width 435mm	
			Depth 490mm	
			Seat height 720mm	
			Seat width 435mm	
			Weight 6kg	

Product information
 Beech plywood shell. Stool and chair stack to 5 high. Tubular frame

Special options
 Chrome steel frame POA
 Other shell options available subject to minimum order quantities

Certification
 Dining chair: BS EN 15373: 2007

Picapau



Product Code: MPPI/A (White), MPPI/B (Green), MPPI/C (Yellow), MPPI/D (Red), MPPI/E (Grey)
Description: Low stool

Price	£	€	Dimensions	Colours
	210	252	Height 465mm	     White Green Yellow Red Grey
			Width 442mm	
			Depth 442mm	
			Weight 3kg	

Picapau

Product Code: GPP1/A (White), GPP1/B (Green), GPP1/C (Yellow), GPP1/D (Red), GPP1/E (Grey)
Description: High stool

Price £ €

240 288

Dimensions

Height 755mm

Width 474mm

Depth 474mm

Weight 4kg

Colours**Product information**

Polypropylene seat
Solid natural beech legs
Steel footrest (high stool)

Please note

Accuracy of printed colours cannot be guaranteed. Please contact Customer Services for colour samples.

Retro

Product Code: MRT1/A (White), MRT1/B (Red), MRT1/D (Light grey), MRT1/E (Green), MRT1/F (Yellow), MRT1/G (Tobacco)
Description: Wood frame chair

Price £ €

295 354

Dimensions

Height 802mm

Width 401mm

Depth 494mm

Seat height 458mm

Weight 5kg

Colours

Product Code: GRT1/A (White), GRT1/B (Red), GRT1/D (Light grey), GRT1/E (Green), GRT1/F (Yellow), GRT1/G (Tobacco)
Description: Wood frame stool

Price £ €

465 558

Dimensions

Height 1069mm

Width 401mm

Depth 533mm

Seat height 765mm

Weight 7kg

Colours**Product information**

Solid beech frame
Polypropylene seat and backrest

Special options

Other wood colours available:
Wenge-stained beech, POA
natural beech, white laquered

Certification

BS EN 15373: 2007
BS EN 1022: 2005



Retro



Product Code: TRT5/A (Beech/white), TRT5/C (Beech/anthracite)
Description: Square dining table, wood legs, MDF top

	£	€	Dimensions		Colours
Price	895	1,074	Height	740	
			Width	800	
			Depth	800	
			Weight	18kg	



Product Code: TRT3/A (Beech/white), TRT3/B (Beech/sand), TRT3/C (Beech/anthracite)
Description: Round dining table, wood column with star base, polypropylene top

	£	€	Dimensions		Colours
Price	525	630	Height	740mm	
			Diameter	700mm	
			Weight	20kg	



Product Code: TRT1/A (Beech/white), TRT1/B (Beech/sand), TRT1/C (Beech/anthracite)
Description: Square dining table, wood column with star base, polypropylene top

	£	€	Dimensions		Colours
Price	560	672	Height	740mm	
			Width	730mm	
			Depth	730mm	
			Weight	20kg	

Café

Product information

Table supplied unassembled
Solid beech frame
TRT5 MDF top
TRT3/trt1 Polypropylene top
TRT3/trt1 steel 4 star base

Special options

Other wood colours available:
Wenge-stained beech

Certification

BS4875: 2001
BS EN 1022: 2005

Please note

Accuracy of printed colours cannot be guaranteed. Please contact Customer Services for colour samples.



Vent

Product Code: MVN1A/AX (Beech), MVN1A/BX (Oak), MVN1A/CX (Wenge), MVN1A/DX (Black),
Description: Dining/meeting chair, chrome frame

Price	£	€	Dimensions		Finishes			
	223	268	Height	885mm				
			Width	490mm	Beech	Oak	Wenge	Black
			Depth	490mm				
			Seat height	445mm				
		Weight	6kg					







Product Code: MVN2A/AX (Beech), MVN2A/BX (Oak), MVN2A/CX (Wenge), MVN2A/DX (Black)
Description: Dining/meeting armchair, chrome frame, arms

Price	£	€	Dimensions		Finishes			
	271	326	Height	885mm				
			Width	570mm	Beech	Oak	Wenge	Black
			Depth	490mm				
			Seat height	445mm				
		Weight	6kg					



Product Code: GVN1A/AX (Beech), GVN1A/BX (Oak), GVN1A/CX (Wenge), GVN1A/DX (Black)
Description: Bar stool, chrome frame

Price	£	€	Dimensions		Finishes			
	259	311	Height	975				
			Width	490	Beech	Oak	Wenge	Black
			Depth	490				
			Seat height	720				
		Weight	8kg					

**Product information**

Beech multilayer wooden shell
20 x 20mm square tube frame in polished and satin-finish chromium-plated steel
Available as a chair or stool, with or without arms
Black polypropylene arm caps
Chair stacks to 5 high
Stool stacks to 4 high

Special options

Upholstered liner POA

Certification

BS4875:part1:2001
BS7945 1999



Xpresso.three

Product Code: MXP1A/NA (Black), MXP1A/OB (White), MXP1A/PC (Red), MXP1A/QD (Green), MXP1A/SI (Grey), MXP1A/TJ (Light blue), MXP1A/UK (Yellow), MXP1A/VL (Purple), MXP1A/WM (Stone)

Description: Perforated back stacking chair, polypropylene seat and back

	£	€
All colours	124	149

Dimensions

Height	830
Width	580
Depth	490
Seat height	460
Seat depth	425
Weight	5kg

Colours



Product Code: MXP1C/NA (Black), MXP1C/OB (White), MXP1C/PC (Red), MXP1C/QD (Green), MXP1C/SI (Grey), MXP1C/TJ (Light blue), MXP1C/UK (Yellow), MXP1C/VL (Purple), MXP1C/WM (Stone)

Description: Perforated back stacking chair, black arms, polypropylene seat and back

	£	€
All colours	201	242

Dimensions

Height	830mm
Width	595mm
Depth	490mm
Seat height	460mm
Seat depth	425mm
Weight	7kg

Colours



Product Code: MXP1A/NF (Black), MXP1A/OF (White), MXP1A/pF (Red), MXP1A/QF (Green), MXP1A/SF (Grey), MXP1A/TF (Light blue), MXP1A/UF (Yellow), MXP1A/VF (Purple), MXP1A/WF (Stone)

Description: Perforated back stacking chair, upholstered seat, polypropylene back

	£	€
Group 0	158	190
Group 1	161	194
Group 2	171	206
Group 3	182	219
Group 4	187	225
Group 5	200	240
Group 6	249	299
Group 7	270	324

Dimensions

Height	830mm
Width	580mm
Depth	490mm
Seat height	460mm
Seat depth	425mm
Weight	8kg

Colours



Product Code: MXP1C/NF (Black), MXP1C/OF (White), MXP1C/pF (Red), MXP1C/QF (Green), MXP1C/SF (Grey), MXP1C/TF (Light blue), MXP1C/UF (Yellow), MXP1C/VF (Purple), MXP1C/WF (Stone)

Description: Perforated back stacking chair, black arms, upholstered seat, polypropylene back

	£	€
Group 0	238	286
Group 1	241	290
Group 2	251	302
Group 3	262	315
Group 4	268	322
Group 5	280	336
Group 6	329	395
Group 7	350	420

Dimensions

Height	830mm
Width	595mm
Depth	490mm
Seat height	460mm
Seat depth	425mm
Weight	10kg

Colours



Product information

Polypropylene fibreglass seat and backrest
Tubular chrome steel frame
Nylon glides
Chairs stackable to 10 high, trolley enables stacking to 45 high.
Stool stacks to 5 high

Special options

	£	€
Linking feet (LXP)	FOC	
Trolley code (MXP)	491	590

Certification

BS EN 15373: 2007



Xpresso.three



Product Code: GXPIA/NA (Black), GXPIA/OB (White), GXPIA/PC (Red), GXPIA/QD (Green), GXPIA/SI (Grey), GXPIA/TJ (Light blue), GXPIA/UK (Yellow), GXPIA/VL (Purple), GXPIA/WM (Stone)
 Description: Perforated back stacking stool, polypropylene seat and back

	£	€
All colours	160	192

Dimensions	
Height	1070mm
Width	600mm
Depth	490mm
Seat height	720mm
Seat depth	425mm
Weight	8kg



Cafe

Zed



Product Code: MZD1/A (White), MZD1/B (Silver), MZD1/C (Black), MZD1/D (Pistachio), MZD1/E (Purple), MZD1/F (Red)
 Description: Swivel bar stool with gas lift and chrome detail

	£	€
Price	490	588

Dimensions	
Height	689-790mm
Width	408mm
Depth	405mm
Weight	18kg

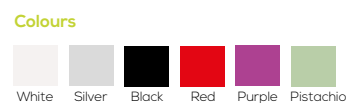

Product information

Polyurethane stool with steel insert and chromium-plated steel footrest
 Chromium plated steel base
 Swivel with gas seat height adjustment

Please note

Accuracy of printed colours cannot be guaranteed. Please contact Customer Services for colour samples.

Design by Paul Brooks

Product Code: MJUIAA

Description: White stacking dining chair, 4 leg silver frame

Price	£	€	Dimensions	Colours
	233	280	Height 885mm Width 612mm Depth 535mm Seat height 480mm Weight 6kg	White

**Product Code: MJUIAC**

Description: White dining chair, silver wire frame

Price	£	€	Dimensions	Colours
	283	340	Height 885mm Width 612mm Depth 535mm Seat height 480mm Weight 6kg	White

**Product Code: MJUIAE**

Description: White dining chair, silver column, 4 star polished aluminium swivel base

Price	£	€	Dimensions	Colours
	347	417	Height 885mm Width 612mm Depth 535mm Weight 480mm 8kg	White

**Product information**

100% moulded polyurethane white shell
4 leg, wire frame, silver painted mild steel
4 star base, polished aluminium

Special options

4 leg, wire frame, chrome steel frame
Cushion

POA
POA



Zest

Design by Paul Brooks



Product Code: MJU2bA (Lime) MJU2cA (Stone), MJU2dA (Graphite)
Description: Dual colour stacking dining chair, 4 leg silver frame

Price	£	€
	236	284

Dimensions	
Height	885mm
Width	612mm
Depth	535mm
Seat height	480mm
Weight	6kg

Colours

Lime Stone Graphite



Product Code: MJU2bc (Lime), MJU2cc (Stone), MJU2dc (Graphite)
Description: Dual colour dining chair, silver wire frame

Price	£	€
	284	341

Dimensions	
Height	885mm
Width	612mm
Depth	535mm
Seat height	480mm
Weight	6kg

Colours

Lime Stone Graphite



Product Code: MJU2bE (Lime), MJU2ce (Stone), MJU2de (Graphite)
Description: Dual colour dining chair silver column, 4 star polished aluminium swivel base

Price	£	€
	368	442

Dimensions	
Height	885mm
Width	612mm
Depth	535mm
Seat height	480mm
Weight	8kg

Colours

Lime Stone Graphite



Product information

100% moulded polyurethane white inner, coloured outer shell
 4 leg, wire frame, silver painted mild steel
 4 star base, polished aluminium

Special options

4 leg, wire frame, chrome steel frame POA
 Cushion POA

Outer shell available in 3 UV resistant colours (shown)

Please note

Accuracy of printed colours cannot be guaranteed.
 Please contact Customer Services for colour samples

Arkura

Product Code: MAK1/A (White), MAK1/B (Yellow), MAK1/C (Red), MAK1/D (Grey), MAK1/E (Sand)
Description: Folding café chair

	£	€
Price	105	126

Dimensions

Height	720mm
Width	460mm
Depth	496mm
Seat height	420mm
Weight	5kg

Colours



Product information

Polypropylene and fibreglass seat and back rest
Embossed painted steel frame



Cafe

Bobo

Product Code: MBO1/A (White), MBO1/B (Red), MBO1/C (Anthracite), MBO1/D (Green), MBO1/E (Yellow), MBO1/F (Sand)
Description: High bar stool, chrome frame

	£	€
Price	168	202

Dimensions

Height	750mm
Width	468mm
Depth	464mm
Weight	8kg

Colours



Product information

Fibreglass filled polypropylene seat
Chrome steel frame



Cafe

Callita

Product Code: MCA1/A (White), MCA1/B (Red), MCA1/C (Black)
Description: Sculptural form chair

	£	€
Price	645	774

Dimensions

Height	810mm
Width	569mm
Depth	532mm
Seat height	459mm
Weight	16kg

Colours



Product information

Painted rigid polyurethane seat
Die-cast aluminium base



Tables





Austen

Design by Roger Webb Associates



Product Code: TAUC/SQL0650FGL/BH4L
Description: Coffee table, square frosted glass top, beech 4 leg base

	£	€	Dimensions	
Price	280	336	Height	480mm
			Width	650mm
			Depth	650mm
			Weight	13kg



Product Code: TAUC/RND0800FGL/BH4L
Description: Coffee table, round frosted glass top, beech 4 leg base

	£	€	Dimensions	
Price	393	472	Height	480mm
			Diameter	800mm
			Weight	15kg



Product Code: TAUC/RND0660FGL/BH4L
Description: Coffee table, round frosted glass top, beech 4 leg base

	£	€	Dimensions	
Price	285	342	Height	480mm
			Diameter	660mm
			Weight	11kg

Product information
 Tables supplied unassembled 10mm
 frosted safety glass, Beech veneer
 plywood legs

Bobbin

Design by Roger Webb Associates

Product Code: TBOC/RND0660WHM/SIPE (White), TBOC/RND0660WAM/SIPE (Walnut),
Description: Coffee table, MFC finish, silver pedestal base

	£	€	Dimensions	
White/walnut	376	452	Height	460mm
Frosted glass	461	554	Diameter	660mm
			Weight	20kg (wood top) 24kg (glass top)



Product Code: TBOD/RND0900WHM/SIPE (White), TBOD/RND0900WAM/SIPE (Walnut)
Description: Dining/meeting table, round top, silver pedestal base

	£	€	Dimensions	
White/walnut	444	533	Height	720mm
			Diameter	900mm
			Weight	25kg



Product Code: TBOP/RND0750WHM/SIPE (White), TBOP/RND0750WAM/SIPE (Walnut)
Description: Poser table, round top, silver column, silver pedestal base

	£	€	Dimensions	
White/walnut	444	533	Height	1060mm
			Diameter	750mm
			Weight	23kg



Product information

Tables supplied unassembled
Laser cut steel base, tubular steel
column with aluminium collar
10mm frosted safety glass
18mm MFC top, ABS edging
Whilst every effort is made to ensure
parity of colour on our table top finishes,
the company cannot guarantee an exact
match on any timber product.

Special options

Other top finishes available
subject to minimum quantity POA



Check

Design by High Design



Product Code: TCKC/RECXXXXOAV/CH4L
Description: Coffee table

	£	€	Dimensions	
Price	539	675	Height	305mm
			Width	600mm
			Depth	1200mm
			Weight	20kg

Emma

Design by Roger Webb Associates



Product Code: TEM1/B (Beech), TEM1/A (Beech/white top), TEM2/B (Oak), TEM2/A (Oak/white top)
Description: Medium dining table, solid oak or beech frame with oak, beech or white veneered top

	£	€	Dimensions	
Beech	1,500	1,800	Height	762mm
Beech/white top	1,450	1,740	Width	1150mm
Oak	1,760	2,112	Depth	1150mm
Oak/white top	1,730	2,076	Weight	26kg



Product Code: TEM3/B (Beech), TEM3/A (Beech/white top), TEM4/B (Oak), TEM4/A (Oak/white top)
Description: Large dining table, solid oak or beech frame with oak, beech or white veneered top

	£	€	Dimensions	
Beech	1,680	2,016	Height	762mm
Beech/white top	1,570	1,884	Width	1400mm
Oak	1,950	2,340	Depth	1400mm
Oak/white top	1,860	2,232	Weight	31kg

Product information

Tables supplied unassembled
Beech or white veneered MDF top
Solid beech or oak legs

Equity

Product Code: TEQC/SQUXXXGLX/CHLE
Description: Coffee table, glass top, square chrome frame

Price	£	€	Dimensions	
	737	885	Height	445mm
		Width	640mm	
		Depth	640mm	
		Weight	13kg	



Product Code: TEQC/RECXXXGLX/CHLE
Description: Coffee table, glass top, rectangular chrome frame

Price	£	€	Dimensions	
	772	927	Height	445mm
		Width	1200mm	
		Depth	640mm	
		Weight	27kg	



Kala

Design by Roger Webb Associates

Product Code: TKAC/SQL0750WHM/SIWI (White), TKAC/SQL0750WAM/SIWI (Walnut)
Description: Squaral top coffee table, silver wire frame

Price	£	€	Dimensions	
	249	299	Height	400mm
		Width	750mm	
		Depth	750mm	
		Weight	10/15kg	



Product Code: TKAC/SQL0750WHM/SI4S (White), TKAC/SQL0750WAM/SI4S (Walnut)
Description: Squaral top coffee table, 4 star base

Price	£	€	Dimensions	
	326	392	Height	400mm
		Width	750mm	
		Depth	750mm	
		Weight	15/19kg	



Equity:
Product information

Tables supplied unassembled
10mm frosted safety glass
Rectangular steel tube

Kala:
Product information

Tables supplied unassembled
18mm MFC top ABS edging

Kala:
Special options

Other table top finishes
available subject to
minimum quantity

POA

Certification

BS EN 7376: 2004



Gloss

Design by David Fox Design



Product Code: TGLC/RND0660WHM/SI4S (White), TGLC/RND0660WAM/SI4S (Walnut), TGLC/RND0660GLX/SI4S (Frosted glass)

Description: Coffee table, round top, 4 star raised polished aluminium base, silver column

	£	€	Dimensions	
White/walnut	266	320	Height	400mm
Frosted glass	445	534	Diameter	660mm
			Weight	10kg (white/walnut) 12kg (glass)



Product Code: TGLC/SQLO750WHM/SI4S (White), TGLC/SQLO750WAM/SI4S (Walnut)

Description: Coffee table, square top, 4 star raised polished aluminium base, silver column

	£	€	Dimensions	
White/walnut	294	353	Height	400mm
			Width	750mm
			Depth	750mm
			Weight	12kg



Product Code: TGLD/RND0900WHM/SI4S (White), TGLD/RND0900WAM/SI4S (Walnut), TGLD/RND0800GLX/SI4S (Frosted glass)

Description: Dining table, round top, 4 star raised polished aluminium base, silver column

	£	€	Dimensions	
White/walnut	287	345	Height	720mm
Frosted glass	497	597	Diameter	900mm (glass 800mm)
			Weight	14kg (white/walnut) 15kg (glass)



Product Code: TGLD/SQLO750WHM/SI4S (White), TGLD/SQLO750WAM/SI4S (Walnut)

Description: Dining table, square top, 4 star raised polished aluminium base, silver column

	£	€	Dimensions	
White/walnut	307	369	Height	720mm
			Width	750mm
			Depth	750mm
			Weight	13kg

Product information

Tables supplied unassembled
18mm MFC top, ABS edging
10mm frosted safety glass
Whilst every effort is made to ensure parity of colour on our table top finishes, the company cannot guarantee an exact match on any timber product.

Special options

	£	€
Beech veneer, add	104	125
Oak veneer, add	67	81
Other show-wood	POA	
Chrome column	POA	

Certification

Glass coffee table (wood top)
BS EN 15372: 2008

Design by David Fox Design

Product Code: TGLP/RND0660GLX/SI4S**Description:** Poser table, round glass top, 4 star raised polished aluminium base, silver column

	£	€	Dimensions	
Frosted glass	455	546	Height	1060mm
			Diameter	660mm
			Weight	14kg

**Product Code:** TGLP/RND0750WHM/SI4S (White), TGLP/RND0750WAM/SI4S (Walnut)**Description:** Poser table, round top, 4 star raised polished aluminium base, silver column

	£	€	Dimensions	
White/walnut	319	383	Height	1060mm
			Diameter	750mm
			Weight	12kg

**Product Code:** TGLP/SQL0750WHM/SI4S (White), TGLP/SQL0750WAm/SI4S (Walnut)**Description:** Poser table, squarial top, 4 star raised polished aluminium base, silver column

	£	€	Dimensions	
White/walnut	326	392	Height	1060mm
			Width	750mm
			Depth	750mm
			Weight	14kg

**Product information**

Tables supplied unassembled
 18mm MFC top, ABS edging
 10mm frosted safety glass
 Whilst every effort is made to ensure parity of colour on our table top finishes, the company cannot guarantee an exact match on any timber product.

Special options

Beech veneer, add	£ 104	€ 125
Oak veneer, add	£ 67	€ 81
Other table top finishes	POA	
Chrome column	POA	

Mortimer

Design by Jones & Partners

Product Code: TMOC/RECXXGLXX/OA4L

Description: Coffee table with oak frame and oak veneer top with inset clear glass



	£	€	Dimensions	
Oak	781	938	Height	385mm
			Width	1200mm
			Depth	600mm
			Weight	17kg

Product Code: TMOC/RECXXXXXX/OA4L

Description: Coffee table with oak frame and oak veneer top



	£	€	Dimensions	
Oak	570	684	Height	385mm
			Width	1200mm
			Depth	600mm
			Weight	13kg

Product Code: TMOC/TRIXXXXXX/OA3L

Description: Triangular coffee table with oak legs



	£	€	Dimensions	
Oak	536	644	Height	385mm
			Width	790mm
			Depth	790mm
			Weight	11kg

Product information

Tables supplied unassembled
 Oak veneer frame
 TMOC/RECXXGLXX/OA4L Inset clear safety glass top

Mortimer

Design by Jones & Partners

Product Code: TMOC/TRISTXXWHM (White), TMOC/TRISTXXBEM (Beech),
TMOC/TRISTXXWAM (Walnut)

Description: Triangular coffee table with silver wire legs

	£	€	Dimensions	
Price	490	588	Height	425mm
			Width	790mm
			Depth	790mm
			Weight	14kg



Product Code: TMOC/RND0660WHM (White), TMOC/RND0660BEM (Beech),
TMOC/RND0660WAM (Walnut)

Description: Round coffee table with silver 4 star base

	£	€	Dimensions	
Price	320	384	Height	440mm
			Diameter	660mm
			Weight	12kg



Product information

Product information
Tables supplied unassembled
Oak veneer frame
Inset clear safety glass top

Special options

TMOC/TRIST Chrome base	POA
TMOC/RND Chrome base	POA
TMOC/TRIST White base	FOC
TMOC/RND White column and base	FOC
Other table top finishes subject to minimum quantity	POA

£ €



Ortega

Design by David Fox



Product Code: TORC/RECXXXOAV/CHWI (Oak), TORC/RECXXXWEV/CHWI (Wenge)
Description: Veneer coffee table, Chromed steel wire frame

	£	€	Dimensions	
Oak	696	836	Height	300mm
Wenge	774	929	Width	1200mm
			Depth	600mm
			Weight	47kg

Retro



Product Code: TRT5/A (Beech/white), TRT5/C (Beech/anthracite)
Description: Square dining table, wood legs, MDF top

	£	€	Dimensions	
Price	895	1,074	Height	740mm
			Width	800mm
			Depth	800mm
			Weight	18kg



Product Code: TRT3/A (Beech/white), TRT3/B (Beech/sand), TRT3/C (Beech/anthracite)
Description: Round dining table, wood column with star base, polypropylene top

	£	€	Dimensions	
Price	525	630	Height	740mm
			Diameter	700mm
			Weight	20kg



Product Code: TRT1/A (Beech/white), TRT1/B (Beech/sand), TRT1/C (Beech/anthracite)
Description: Square dining table, wood column with star base, polypropylene top

	£	€	Dimensions	
Price	560	672	Height	740mm
			Width	730mm
			Depth	730mm
			Weight	20kg

Product information

Tables supplied unassembled
Solid beech frame
TRT5 MDF top
TRT3/TRTL Polypropylene top
TRT3/TRTL steel 4 star base

Special options

Other wood colours available:
Wenge-stained beech

Certification

BS4875: 2001
BS EN 1022: 2005

Please note

Accuracy of printed colours cannot be guaranteed. Please contact Customer Services for colour samples.

Colours



Swoosh

Design by Roger Webb Associates

Product Code: TSWC/RND0660WHM/SIWI (White), TSWC/RND0660WAM/SIWI (Walnut), TSWC/RND0660GLX/SIWI (Frosted glass)

Description: Coffee table, round top, white or silver wire base

	£	€	Dimensions	
White/walnut	259	311	Height	400mm
Frosted glass	367	441	Diameter	660mm
			Weight	8kg (white/walnut) 13kg (glass)



Product Code: TSWC/RND0750WHM/SIWI (White), TSWC/RND0750WAM/SIWI (Walnut)

Description: Coffee table, round top, white or silver wire base

	£	€	Dimensions	
White/walnut	262	315	Height	400
			Diameter	750mm
			Weight	10kg



Product Code: TSWC/SQU0750WHM/SIWI (White), TSWC/SQU0750WAM/SIWI (Walnut)

Description: Coffee table, square top, white or silver wire base

	£	€	Dimensions	
White/walnut	264	317	Height	400mm
			Width	750mm
			Depth	750mm
			Weight	10kg



Product information

Tables supplied unassembled
18mm MFC top, ABS edging
10mm frosted safety glass
Whilst every effort is made to ensure parity of colour on our table top finishes, the company cannot guarantee an exact match on any timber product.

Special options

Chrome frame POA



Swoosh

Design by Roger Webb Associates



Product Code: TSWC/RND0660WHM/SI4S (White), TSWC/RND0660WAM/SI4S (Walnut), TSWC/RND0660GLX/SI4S (Frosted glass)
Description: Coffee table, round top, white or silver column, white or polished aluminium 4 star base

	£	€	Dimensions	
White/walnut	275	330	Height	400mm
Frosted glass	362	435	Diameter	660mm
			Weight	11kg (white/walnut) 13kg (glass)



Product Code: TSWC/RND0750WHM/SI4S (White), TSWC/RND0750WAM/SI4S (Walnut), TSWC/RND0800GLX/SI4S (Frosted glass)
Description: Coffee table, round top, white or silver column, white or polished aluminium 4 star base

	£	€	Dimensions	
White/walnut	279	335	Height	400mm
Frosted glass	406	488	Diameter	750mm (glass 800mm)
			Weight	12kg (white/walnut) 17kg (glass)



Product Code: TSWC/SQU0750WHM/SI4S (White), TSWC/SQU0750WAM/SI4S (Walnut), TSWC/SQU0650GLX/SI4S (Frosted glass)
Description: Coffee table, square top, white or silver column, white or polished aluminium 4 star base

	£	€	Dimensions	
White/walnut	281	338	Height	400mm
Frosted glass	361	434	Width	750mm (glass 650mm)
			Depth	750mm (glass 650mm)
			Weight	13kg (white/walnut) 14kg (glass)

Product information

Tables supplied unassembled
18mm MFC top, ABS edging
10mm frosted safety glass
Whilst every effort is made to ensure parity of colour on our table top finishes, the company cannot guarantee an exact match on any timber product.

Special options

Chrome frame

£ €

POA

Swoosh

Design by Roger Webb Associates

Product Code: TSWD/RND0900WHM/SI4S (White), TSWD/RND0900WAM/SI4S (Walnut), TSWD/RND0800GLX/SI4S (Frosted glass)

Description: Dining table, round top, white or silver column, white or polished aluminium 4 star base

	£	€	Dimensions
White/walnut	289	347	Height 720mm
Frosted glass	406	488	Diameter 900mm (glass 800mm)
			Weight 15kg (white/walnut) 18kg (glass)



Product Code: TGLP/RND0750WHM/SI4S (White), TGLP/RND0750WAM/SI4S (Walnut)

Description: Dining table, squaral top, white or silver column, white or polished aluminium 4 star base

	£	€	Dimensions
White/walnut	285	342	Height 720mm
			Width 750mm
			Depth 750mm
			Weight 14kg



Product Code: TSWD/RND0750WHM/SI4S (White), TSWD/RND0750WAM/SI4S (Walnut), TSWD/RND0660GLX/SI4S (Frosted glass)

Description: Dining table, round top, white or silver column, white or polished aluminium 4 star base

	£	€	Dimensions
White/walnut	283	340	Height 720mm
Frosted glass	369	443	Diameter 750mm (glass 660mm)
			Weight 13kg (white/walnut) 14kg (glass)



Swoosh



Product Code: TSWP/SQU0750WHM/SI4S (White), TSWP/SQU0750WAM/SI4S (Walnut), TSWP/SQU0650GLX/SI4S (frosted glass)
Description: Poser table, squarial top, white or silver column, white or polished aluminium 4 star base

	£	€	Dimensions	
White/walnut	293	352	Height	1060mm
Frosted glass	371	446	Width	750mm (glass 650mm)
			Depth	750mm (glass 650mm)
			Weight	14kg (white/walnut) 16kg (glass)



Product Code: TSWP/RND0750WHM/SI4S (White), TSWP/RND0750WAM/SI4S (Walnut), TSWP/RND0660GLX/SI4S (Frosted glass)
Description: Poser table, round top, white or silver column, white or polished aluminium 4 star base

	£	€	Dimensions	
White/walnut	291	350	Height	1060mm
Frosted glass	372	447	Diameter	750mm (glass 660mm)
			Weight	13kg (white/walnut) 15kg (glass)

Product information

Tables supplied unassembled
 18mm MFC top, ABS edging
 10mm frosted safety glass
 Whilst every effort is made to ensure parity of colour on our table top finishes, the company cannot guarantee an exact match on any timber product.

Special options

Chrome frame

£ €

POA

Product Code: TTEC/SQU0650GLX/SIPE

Description: Coffee table, square glass top, silver column and base

	£	€	Dimensions	
Price	532	639	Height	460mm
			Width	650mm
			Depth	650mm
			Weight	28kg



Product Code: TTEC/SQU0750WHM/SIPE (White), TTEC/SQU0750WAM/SIPE (Walnut)

Description: Coffee table, square top, silver column and base

	£	€	Dimensions	
Price	422	507	Height	460mm
			Width	750mm
			Depth	750mm
			Weight	25kg



Product Code: TTED/SQU0900WHM/SIPE (White), TTED/SQU0900WAM/SIPE (Walnut)

Description: Dining/meeting table, square top, silver column and base

	£	€	Dimensions	
Price	448	538	Height	720mm
			Width	900mm
			Depth	900mm
			Weight	29kg



Product information

Tables supplied unassembled
Product information
Tables supplied unassembled
18mm MFC top, ABS edging
10mm frosted safety glass
Whilst every effort is made to ensure parity of colour on our table top finishes, we cannot guarantee an exact match on any timber product.

Special options

Other top finishes available subject to minimum quantity, POA

Certification

BS 7376: 2004

Zeus



Product Code: TZEC/OVLXXXXWHM/SIPE (White)
 Description: Oval coffee table

	£	€	Dimensions	
Price	250	300	Height	520mm
			Width	350mm
			Depth	570mm
			Weight	13kg



Product Code: TZED/OVLXXXXWHM/SIPE (White)
 Description: Oval dining table

	£	€	Dimensions	
Price	305	366	Height	700mm
			Width	350mm
			Depth	570mm
			Weight	13kg

Product information

Tables supplied unassembled
 18mm MFC top with ABS edging
 Other table top finishes available on request

Special options

Chrome column POA
 White column, chrome collar, silver oval pedestal base POA



The Designers

Hilary Birkbeck

Hilary Birkbeck is a furniture and product designer who has been practising in the UK for 30 years. He has a wealth of experience and has provided product solutions for the UK commercial contract markets and domestic retail sectors (Harrods, Heals and John Lewis). He has great understanding of the global supply chain and manufacturing practices. His specialist areas are ergonomics, health and safety and product innovation. Hilary has ongoing activities with US, European and East European clients.

Paul Brooks

Paul Brooks Design has placed itself in the centre of Europe. They have a European approach in the understanding of today's global market. Their belief is to work closely with their client, aiming to analyse their needs in order to deliver a totally appropriate solution – aesthetically, functionally and commercially. They are specialists in the area of office furniture and offer a full design and development package. They have a proven track record which assures informed design, flexibility, common sense and attention to detail.

David Fox Design

David Fox Design is an award winning industrial and product design consultancy. His philosophy and work ethic promote elegance and refinement. His well balanced, innovatively detailed, simplistic forms give his work a timeless aesthetic. David works with a number of clients on furniture and industrial design related projects. In 2007 and 2009 he won the Mixology North Designer of the Year and with the Kalm chair won the FX Award.

High Design Ltd

Bruce High established UK based High Design Ltd. They have designed successful award winning commercial furniture for leading international design-led clients offering an extensive design service through to a finished product. This is underpinned by a pragmatic and hands on approach to design and product development, ensuring close collaboration with clients from initial conceptual ideas through to the final production stage. Their designs aim to enhance and attain the very best aesthetic form, function and quality of finish achievable by the selected materials. Combined with their ability to understand the marketplace and bring about well-conceived concepts into enduring and successful products.

Jones & Partners

Craig Jones Design is a London-based design practice committed to the development of high quality furniture and product design. Established in 2000, the company's aim is to provide a complete and fully resourced service to their clients that produce exciting designs with solid commercial viability. The company collaborates with design-led businesses which share their vision for beautiful and intelligent design solutions. They handle the process from conception through to production and have a proud record dealing with multi-national organisations on projects that have been manufactured and distributed in every corner of the globe.

Ratio Design Associates

Established in 2002, Ratio is an industrial design consultancy working across a diverse range of market sectors from consumer electronics to desking systems. Their experienced team consistently delivers commercially successful, lasting product design solutions that sell worldwide. From concept to manufacture they have a straightforward, intuitive design approach, complemented by rigorous development and engineering expertise.

Roger Webb Associates

Established in 1989, Roger Webb Associates have become synonymous with creating award winning solutions for many of the key brands in the furniture industry within the UK and Europe. One of their key strengths is to go beyond design aesthetics and into designing how pieces are developed and manufactured. Their passion for design is specifically tailored to clients' needs, supporting them to achieve a leading position in their market. The design service is focused through research, in close collaboration with the client to create and develop designs involving prototyping, product engineering and supporting the client by project managing the design into production and to market.



Hilary
Birkbeck



Paul
Brooks



David Fox
Design



High
Design Ltd



Jones &
Partners



Ratio Design
Associates

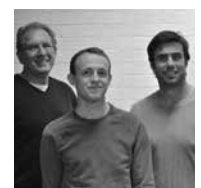

Roger Webb
Associates

Ordering Guidelines

Pricing

All prices shown in sterling (£) are subject to VAT.

Terms of payment

Nett 30 days from the date of invoice. Connection retains title and ownership of all goods until they have been paid for in full.

Acknowledgement of orders

All orders will be acknowledged. Please check acknowledgements and contact customer services as soon as possible if there are any amendments to your order. Connection cannot be held responsible for customer error or omissions. Once an order acknowledgement has been sent, the order will go into production. Any amendments received after this date may be chargeable.

Ordering procedure

Orders must be placed in writing and include the following:

- Product code (With options e.g. mechanism, arm-type and colour, base type and colour)
- Fabric range and code
- Quantity
- Delivery address
- Desired delivery date

Please make all orders as clear as possible as this will enable us to provide a more efficient delivery.

Delivery lead times

Lead times may vary due to the fabrics selected on the product and/or component requirements. Once your order is received Connection will acknowledge the order with a confirmed week ending delivery date. In the event that our lead time does not meet your requirements, please contact our customer services who will investigate the possibility of rescheduling the items on your order to meet your expectations.

Sample chairs

Standard sample requests are delivered free of charge as part of our service. We would request these are returned to us in good condition within a 30 day period. Special requests other than standard will not be deemed as sale or return and will be treated as an order.

Specification

All dimensions and weights are approximate; whilst every care is taken to ensure their accuracy, Connection cannot be held responsible for errors. Connection reserve the right to make, without notice, any changes to materials, specifications or design of the products which it considers to be reasonable or desirable. Such changes shall not affect the validity of the contract. Connection reserves the right to amend or change the pricing structure within this publication. Our website has our full policies on guarantee, delivery, continuity of supply and our customer service charter.

Fabric Specification

All products manufactured by Connection are upholstered and assembled to the highest standard. However, due to the characteristics and performance of certain fabrics the final appearance and finish on the product may be adversely affected by the fabric specified. Where a material is specified for a product which may have properties that do not meet the necessary requirements, our customer service team will contact you, advising you of any issues. If you decide to proceed with the chosen fabric, then Connection cannot be held responsible for issues relating directly to the material. Whilst every effort is made to ensure parity of colour on our fabric finishes, the company cannot guarantee an exact match on any fabric.

Where a customer is supplying their own fabric, and the fabric does not appear in the Connection fabric matrix the following shall apply:

- £150 patterning charge to cover creating templates.
- A quantity of fabric must be supplied to Connection to facilitate creating new templates - 5m per soft seating product, 2m per task/meeting product. For larger sofas a greater quantity may be required. This fabric will be used in the templating/design process.
- Once the fabric is approved, the order will be processed on standard lead time (starting from the date of approval).
- In the event that the fabric is deemed unsuitable for the requested product, the patterning charge will be refundable.



Delivery

Delivery Schedules

All standard Connection deliveries are made on tailgated vehicles to the designated warehouse of the customer. The standard delivery service operates Monday to Friday, with deliveries to a customer's warehouse between 7am and 7pm.

Connection delivers to mainland UK post codes on a fortnightly schedule with the majority of areas delivered weekly at our discretion. On receipt of your official purchase order, an order acknowledgement will be returned to you detailing the week ending your delivery will be made. Our Customer Services team will contact you between 24 and 48 hours prior to book the delivery in.

Small order charges

For a customer warehouse delivery, where the net order value is below £500, a charge of £50 will be applied. All small order deliveries will be made in line with our scheduled tailgate delivery.

Direct Deliveries

Where requested, deliveries can be made direct to site. For specific deliveries with a net order value between £5,000 and £10,000 there will be no delivery charge providing the delivery is made in line with our scheduled tailgate delivery.

For all specific deliveries where the net order value is below £5,000, a fee of £150 will be applied to all direct delivery requests. The delivery day for such deliveries will be in line with our scheduled tailgate delivery program.

Requests for a specific delivery date and time can also be facilitated; however additional charges will be made to meet this requirement. Details of the specific costs will depend on the size of delivery and the date required. Full details of these can be obtained through our customer services team.

Large Deliveries

On deliveries where the individual delivery is above £10,000 net order value, then the customer can specify the delivery date and time. These deliveries will not be chargeable, providing the date and time specified is Monday – Friday between 8am and 5pm.

Connection delivers products on vehicle types most suited to the size and specification of the products being delivered. Where the customer places restrictions on the type and size of vehicle used, additional charges will be applied to the delivery to cover such requests.

Installation

All our deliveries are based on a tailgate service, with unloading to the rear of the vehicle. Connection can, with sufficient notice, offer an installation service. This additional service is chargeable and details of the specific charges can be obtained through our customer service team.

Order Postponement

Where a customer advises Connection of a postponement of an order giving a minimum of a week's notice from the scheduled delivery, no charge will be made providing the order is rescheduled for delivery. If the postponement of an order is advised to Connection with less than one week's notice, Connection will raise charges to cover for storage and handling of the products on order. All requests for postponement must be in writing.

Checking the Delivery

All items must be individually counted. Our logistics partner will not accept any signatures marked "UNCHECKED". Please verify the number of items received with the number shown on the delivery document which you are required to sign. You must only sign for the actual number of items received, any discrepancies to the advised quantities must be written on the delivery documentation. Neither our logistics provider nor ourselves will be held responsible for any shortages found after the delivery paperwork has been signed.

Damaged Goods

Any visible damage on delivery must be signed as such on the delivery documentation. If any items should arrive damaged, including water damaged, you must sign the carriers note as "damaged". All damages must be notified to our offices within 48 hours of the delivery. Neither our logistics provider nor ourselves can accept responsibility if we are informed after this time period.

Goods for Collection

Only goods that have been pre-advised for collection will be accepted by our delivery driver. All goods that are to be returned to Connection must be advised to our Customer Service Team 72 hours before the date of your standard delivery.

Warranty Statement

The company's warranty and guarantee are valid only on standard products supplied in mainland UK and given subject to the product being used for the purpose for which they are designed, with the exception of fair "wear and tear".

All standard products supplied are guaranteed against defective components and workmanship from the date of manufacture, the details of which are as follows:

- 1 Structural and moving parts, under fit for purpose use for a period of five years.
- 2 Upholstery:
 - foam, under fit for purpose use and service for a period of five years;
 - fabric, all material used is covered by the fabric manufacturers own warranty/guarantees.
- 3 Product in twenty four hour use will be limited to a twelve month warranty.

The warranty is valid only where:

- 1 Repairs are carried out by a third party that has been appointed directly by Connection Seating Ltd.
- 2 The goods have been paid for in full.
- 3 The product has been used for the purpose for which it has been designed and has not been subject to misuse, unauthorised repair, replacement, modification or alteration in any way.

If you would like to know more, please contact:

clare.kendall@connection.uk.com



Export Information

Connection is a UK based company, with a brand that has developed overseas. On our website there is a section under Export translated into French and German. These pages provide more in depth information on our export procedures and give details of our representatives in countries outside the UK.

Here are brief guidelines on ordering for export:

- All goods are exempt from UK VAT.
- The customer is responsible for all import tax duties unless agreed in writing by Connection.
- Payment terms are nett 30 days from date of invoice. Standard export terms are pro forma payment prior to despatch unless otherwise agreed to by Connection in writing.
- Our ordering processes and acknowledgements are standard for exported goods and UK goods.
- Prices will be quoted in Sterling and Euros and are based on ex factory unless otherwise agreed by Connection in writing.

Warranty Guidelines

The standard warranty applies for product shipped outside the UK. Warranty claims for product outside the UK must be handled by the original supplying Connection customer who will be required to adhere to the following procedure:

- Complete a Connection "non-conformance" form. This must be returned to the company's Head Office in Huddersfield, UK, with all requested details, together with supporting imagery. The purpose of this is for the company to be able to respond promptly and effectively.
- Upon receipt of completed documentation, we will respond within 72 hours with an agreed action plan.
- Subject to the claim being valid, Connection will arrange to supply replacement parts delivered to the nearest port of entry. We will not cover sequential loss and it will be the responsibility of the supplying customer to effect the repair.
- Any agreed amendments to the above will be required to be confirmed in writing between all parties concerned.

Delivery

Connection utilise state of the art logistic systems to facilitate deliveries to our customer's premises. Our Customer Service team will advise of an estimated time of arrival once the goods have been collected from Connection for shipment. A confirmed delivery date can only be given once all local import duties have been paid.

Deliveries to EU countries

Connection predominately offer ex works pricing on all export orders, however where required we can facilitate the arrangement of transport. Where a customer's delivery is required to be arranged by Connection, the following charges are applicable.

Small Order Charges

For a customer warehouse delivery, where the net order value is below £1500, a charge of £150 will be applied.

Standard Order Delivery Charges

Where requested, Connection can arrange deliveries direct to site. Prices for these are specific to a customer request, and as such will be priced on application. Connection cannot arrange installation for any Export deliveries, this needs to be arranged locally by the customer.

Order Postponement

Where a customer advises Connection of a postponement of an order giving a minimum of one weeks notice from the scheduled collection/delivery, no charge will be made providing the order is rescheduled for collection/delivery.

If the postponement of an order is advised to Connection with less than one weeks notice, Connection will raise charges to cover for storage and handling of the products on order. All requests for postponement must be in writing.

Connection package products for export customers based on them being loaded directly onto a designated container. Where the product is to be shipped through a groupage network, then Connection have designed and developed additional "Sea Worthy" packaging which is strongly recommended to be used on all such shipments. This packaging does have an additional charge applied to the shipment, details of which can be obtained through our customer services team. If customers do not request this additional packaging for groupage items as recommended, then Connection cannot be held responsible for any damages caused through the transportation of the product.

Export contact

Patricia Theaker

T: +44 (0)1484 600112

E: patricia.theaker@connection.uk.com

Middle East contact

Justine Welch

T: +971 509 128700

E: justine.welch@connection.uk.com

Fabric Options

Group 0	
Supplier	Range
Bradbury	Omega Plus
Bradbury	Pyra
Bradbury	Stirling
Camira	Advantage
Camira	Phoenix

Group 1	
Supplier	Range
Camira	Manhattan
Camira	Sprint
Camira	Xtreme Plus
Camira	X2
Chieftain	Trimcell Classic
Gabriel	Event
Gabriel	Fighter
Macflex	Oporto V
Panaz	Aston
Yarwood Synthetic	Dollaro 80

Group 2	
Supplier	Range
Bradbury	Carnival
Bradbury	Flamblend
Camira	Main Line Plus
Camira	Main Line Flax
Camira	Vita V
Camira	Folio V
Camira	Nexus
Camira	Urban Plus
Camira	Velvetine Plus
Chieftain	Just Colour V
Chieftain	Trimcell Legend V
Yarwood Synthetic	Losana Etna V
Yarwood Synthetic	Losana Ibiza V

Group 3	
Supplier	Range
Abbotsford	Feast
Camira	Aquarius
Camira	Blazer
Camira	Denim
Camira	Halcyon
Camira	High-Tech
Camira	Intervene
Camira	Marvel
Camira	Oxygen
Camira	24/7+
Connection	Syntec V
Gabriel	Europost
Gabriel	Gaja
Gabriel	Step
Moon	Spectrum
Moon	Earth
Spectrum	Colour Palette Vinyl V
Vescom	Furka Plus V

Group 4	
Supplier	Range
Camira	Blazer Check
Camira	Hebden Plus
Camira	Hemp Plus
Camira	Monroe
Camira	Timeline
Gabriel	Fame
Gabriel	Step Melange
Kvadrat	Lazio 2

Group 4 (cont)	
Supplier	Range
Moon	Carnaby
Moon	Chalet
Moon	Heather
Vescom	Brant V
Vescom	Cres
Vescom	Dalma V
Vescom	Dodan V
Vescom	Keri V
Vescom	Leone Plus V
Vescom	Samar
Vescom	Sanak V

Group 5	
Supplier	Range
Abbotsford	Exhilerate
Bute	Roslyn
Camira	Binary Plus
Camira	Craggan
Camira	Monochrome Stripe Plus
Camira	Smarty Plus
Camira	Sting Plus
Camira	Stripes Plus
Camira	Stripes 2 Plus
Chieftain	Multi Stretch V
Chieftain	Lionella
Gabriel	Code
Gabriel	Delfi 2
Kvadrat	Field
Kvadrat	Messenger 3
Kvadrat	Pause 3
Kvadrat	Remix
Kvadrat	Scuba V
Vescom	Ambu
Vescom	Honshu
Vescom	Lombok
Yarwood Synthetic	Batani V
Yarwood Synthetic	Natur V

Group 6	
Supplier	Range
Bute	Elgin
Bute	Kames
Bute	Skye
Bute	Troon
Bute	Turnberry
Camira	Blazer Hourglass
Camira	Blazer Quilt
Camira	Blazer Quilt Channel
Camira	Blazer Quilt Hourglass
Camira	Tangled
Gabriel	Arlanda
Gabriel	Blake
Gabriel	Byron
Gabriel	Comfort 8580
Gabriel	Digital 2
Gabriel	Luna
Kvadrat	Bass 3
Kvadrat	Cava 3
Kvadrat	Divina 3
Kvadrat	Divina Melange 2
Kvadrat	Flora 2
Kvadrat	Highfield
Vescom	Antigua
Vescom	Bikar
Vescom	Bowen
Vescom	Keros

Group 6 (cont)	
Supplier	Range
Vescom	Naura
Vescom	Lani
Vescom	Lindau
Vescom	Ponza
Vescom	Yuma

Group 7	
Supplier	Range
Camira	Titus
Gabriel	Comfort 8636
Kvadrat	Hallingdal 65

Leather 1	
Supplier	Range
Yarwood	Style
Yarwood	Camden

Leather 2	
Supplier	Range
Camira	Classic Plus
Camira	Vintage Plus
Crest	Shelly
Crest	Vele
Andrew Muirhead	Ingelston
Andrew Muirhead	Lustrana
Yarwood	Capri
Yarwood	Mustang

Leather 3	
Supplier	Range
Andrew Muirhead	Grampian
Andrew Muirhead	Sateen

V indicates vinyl

When we receive your order we will check with our suppliers that the chosen fabric is in stock, then advise you of a suitable delivery time.

Please note: Not all of our standard fabrics, vinyls and leather are suitable for all of our products.

Quality and colour finishes on fabric are as per the fabric supplier's standards, therefore any issues relating to this fall outside of Connection's warranty and quality measurements.

Where a customer is supplying their own fabric, and the fabric does not appear in the above list, the following shall apply:

- £150 patterning charge to cover creating templates.
- A quantity of fabric must be supplied to Connection to facilitate creating new templates - 5m per soft seating product, 2m per task/meeting product. For larger sofas a greater quantity may be required. This fabric will be used in the templating/design process.
- Once the fabric is approved, the order will be processed on standard lead time (starting from the date of approval).
- In the event that the fabric is deemed unsuitable for the requested product, the patterning charge will be refundable.



Head Office

Dogley Mills
Penistone Road
Fenay Bridge
Huddersfield
West Yorkshire
HD8 0LE

Tel: 01484 600 100
sales@connection.uk.com

London Showroom

32/33 Dallington Street
Clerkenwell
London
EC1V 0BB

Tel: 020 7253 9877
www.connection.uk.com

connection
space that works