

# CENBRIT

# Cembrit Facade on Aluminium

Cembrit Patina, Cembrit Cover, Cembrit Solid, Cembrit Transparent

## Installation

### Table of Contents

Cembrit	2	Profiles	26
The Self-ventilating Facade	4	Onsite Handling	30
Product Range	6	Storing and Handling	31
Installation	8	Care and Maintenance	32
Accessories	22	Health and Safety	34



# Cembrit

## Cembrit

Cembrit is one of the leading European manufacturers of multi-capability fibre cement building products. Our products and solutions add exciting new design opportunities for moulding attractive, durable settings for people's lives. But Cembrit is more than mere products. We also help make all kinds of design and construction projects easier as well as more profitable, inspiring and effective.

And for us, all construction also involves building relations with people, making your day better, and helping you make the day better for others.

## Product Information

Cembrit fibre cement is a modern building material made from natural and environmentally friendly raw materials. The technology has been developed by Cembrit, having more than 90 years of experience within the manufacture of fibre cement. Our wide experience ensures a sustainable product which has accumulated all the advantages of fibre cement.

The facade range can be used in all self-ventilated light weight facade constructions. Featuring properties such as non-combustibility, sound and weather insulation as well as high impact strength, Cembrit fibre cement boards are the ideal facade material.

## Warranty

Warranty conditions are available on request from your local Cembrit office.

## Quality

Cembrit product specifications and classifications comply with EN 12467:2012 and 13501-1:2007+A1:2009

## The facade range

- is manufactured in accordance with the quality management system ISO 9001:2015
- complies with the provisions set out in the Construction Products Regulation (EU) No. 305/2011

## Disclaimer

The information contained in this publication and otherwise supplied to users of Cembrit products is based on Cembrit's general experience, best knowledge and belief. However, due to factors which fall beyond Cembrit's knowledge and control, which can affect the use of the products, no warranty is given, express or implied with respect to fitness for particular purpose or otherwise.

Cembrit's policy is one of continuous improvement. Cembrit therefore reserves the right to alter specifications at any time and without notice. Colours and textures may vary according to light and weather conditions. Owing to this and limitations of the printing process, colours in this brochure may vary.

Please, ensure that you have the latest version of this publication by checking that the publication date corresponds with the downloadable version from our website. In case of doubt, please contact your local Cembrit representative.

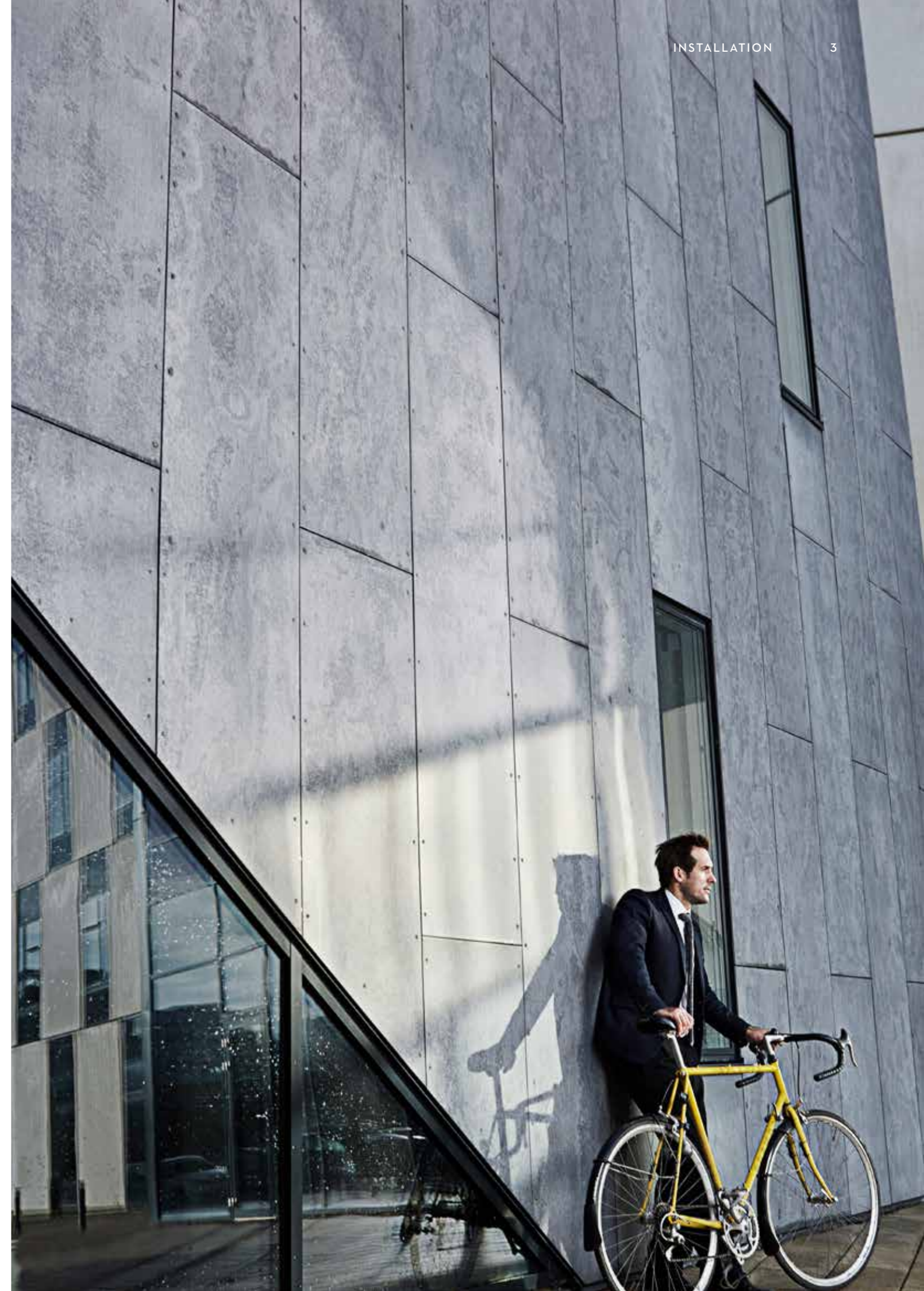

# The self-ventilating facade

A self-ventilating facade is a construction which helps minimise temperature variations in the wall throughout the year. Sunlight and heat are reflected away in the summertime, and insulation behind the facade boards reduces heat loss in lower temperatures.

At the same time, the natural ventilation passing through the construction minimises condensation.

The self-ventilating facade has additional features and benefits.

The most important benefit is the protection of the underlying construction against weather, wind and moisture. Some moisture passes through the facade, but it is limited to a level that can either be drained away or eliminated by natural ventilation.

The drainage feature of the system works when rainwater or moisture penetrates through the gaps in the facade. The moisture runs down either the reverse of the facade boards, the windstopper, or the insulation. There should be ventilation openings at the base of the structure and above doors and windows. These openings will also help drain the water away from the construction.

The natural ventilation works by means of a chimney effect. The air enters at the bottom of the structure and on its way up through the facade takes moisture-laden air through the ventilation openings at the top of the structure or at window or door openings.

The boards can be installed with open horizontal joints or with joint profiles. Horizontal joints between boards contribute minimally to natural ventilation and therefore profiles can be used in these joints, if required.

### Aluminium construction on heavy wall

1. Cembrit facade board
2. Flat EPDM optional
3. T or L profile
4. Bracket /insulator
5. Insulation
6. Ventilated area minimum 50mm
7. Back wall

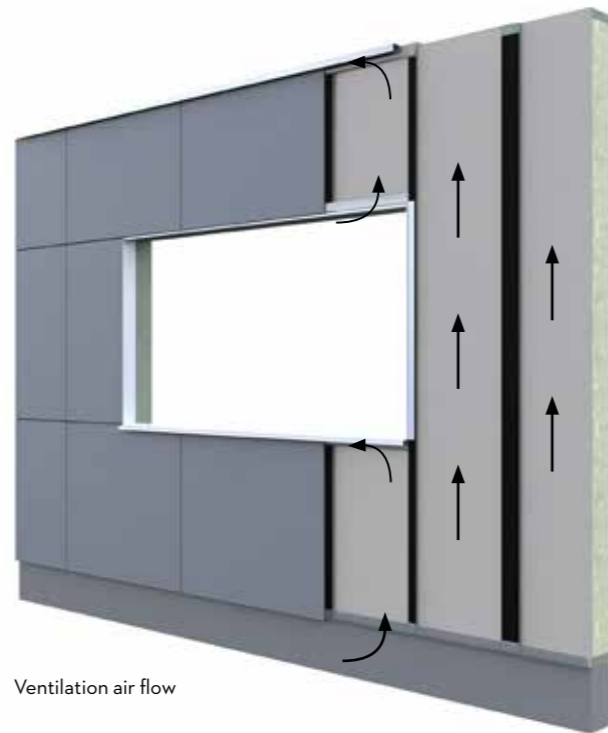

Ventilation air flow

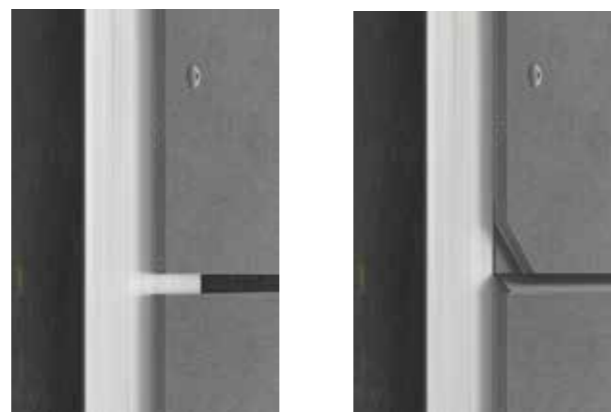

Open joints

Joint profile

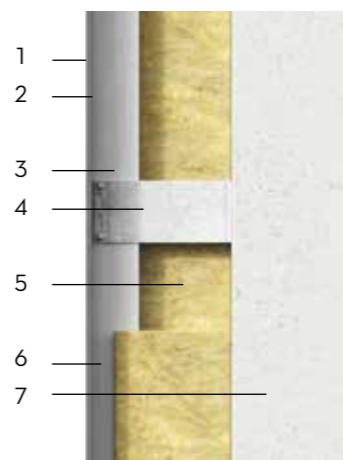

# The self-ventilating facade

## Ventilated Openings

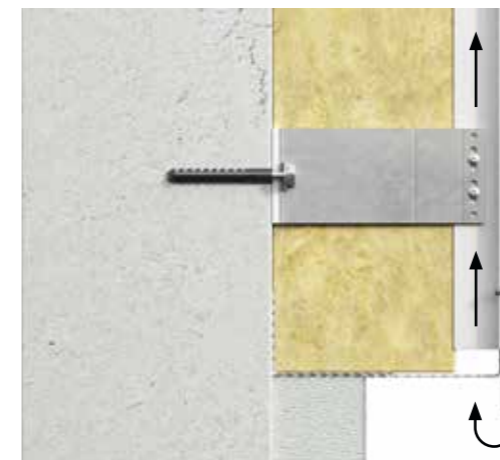

Air is pulled into the construction through an opening at the base of the facade, and it must be ensured that unobstructed ventilation is possible throughout the facade's height. There should be a ventilation gap of minimum 10mm, or equivalent 100cm<sup>2</sup> per meter. If perforated profiles are used, a ventilation area opening of minimum 100cm<sup>2</sup> per meter is required. The opening at the base is also used to drain moisture that has entered the facade.

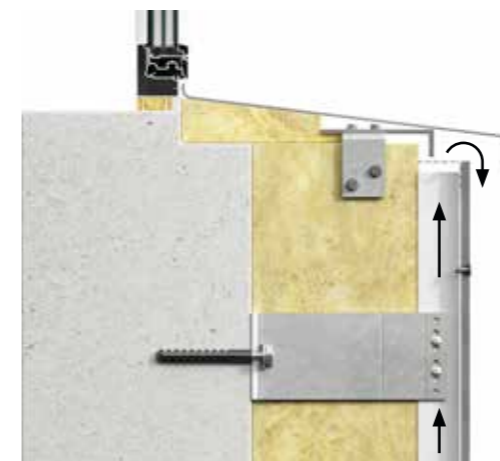

A horizontal ventilation opening of minimum 10mm or equivalent to 100cm<sup>2</sup> per meter should be maintained beneath windows or other openings where a sill is used. This ventilation gap is usually formed between the top edge of the facade boards and the bottom edge of the sill. It is recommended that the sill projects a minimum of 30mm beyond the front of the facade. This ensures that the water running from the sill does not enter the structure.

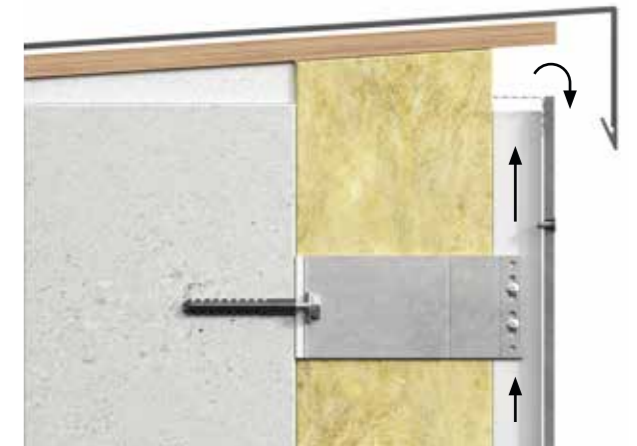

The passage of air must be maintained at the top of the facade whether it abuts to a roof or other structure. Just as at the base, there must be a ventilation gap of a minimum of 10mm or 100cm<sup>2</sup> per meter.

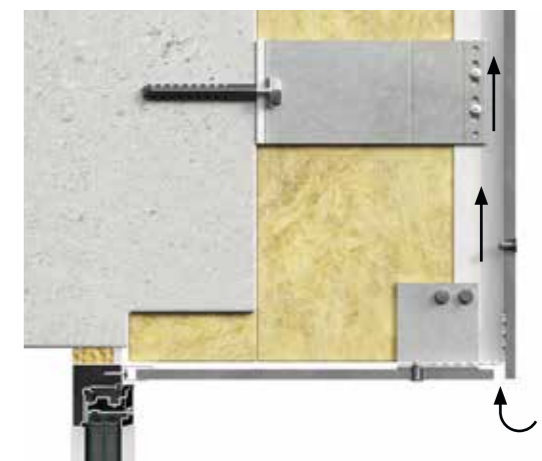

A horizontal free ventilation opening must be maintained above windows and doors as well. This ventilation gap must be at least 10mm wide. If steel, aluminium or plastic perforated profiles are used, a ventilation area opening of minimum 100cm<sup>2</sup> per meter is required. The opening at the base is also used to drain moisture that has entered the facade.

# Product Range

Cembrit Patina

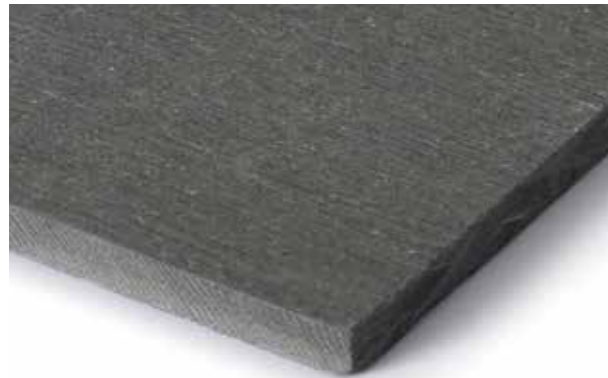

**Directional grain**

Cembrit Patina's manufacturing process gives the boards a unique surface texture. This unique finish is enhanced by a process which adds a directional grain to the board - leaving the boards with a different appearance dependent on lighting and the angle of the board. By rotating boards within the facade makes it possible to obtain a playful visual effect - depending on the viewer's position and the lighting conditions.

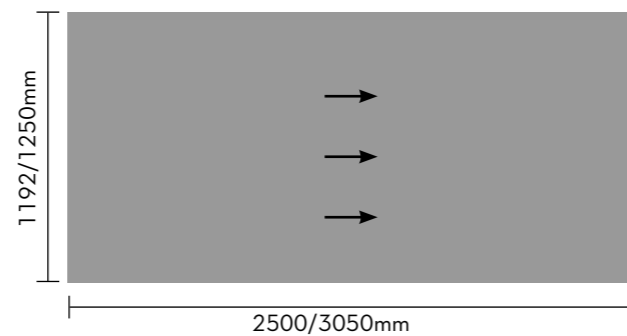

Quick facts	Type	Fire class	Thickness	Dimensions	Weight/m <sup>2</sup>
Cembrit Patina	Through coloured	A2,s1-d0	8mm	1192x2500mm 1192x3050mm 1250x2500mm 1250x3050mm	12.1 kg/m <sup>2</sup>

# Product Range

Cembrit Cover

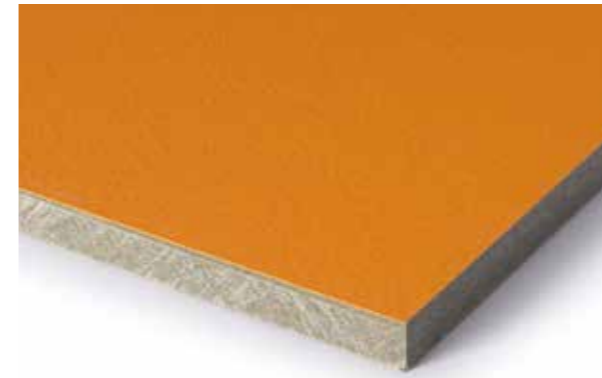

Cembrit Solid

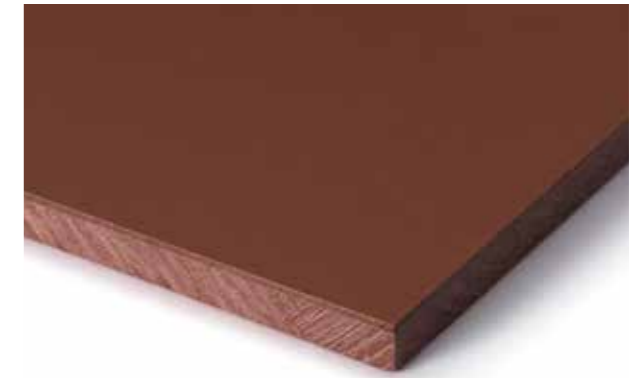

Cembrit Transparent

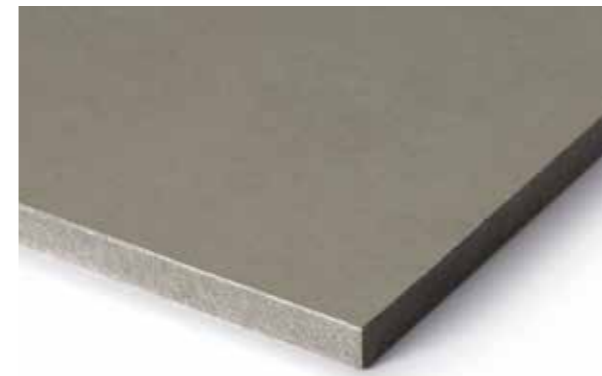

Quick facts	Type	Fire class	Thickness	Dimensions	Weight/m <sup>2</sup>
Cembrit Cover	Non-Through coloured	A2,s1-d0	8mm	1192x2500mm 1192x3050mm 1250x2500mm 1250x3050mm	14.2kg/m <sup>2</sup>
Cembrit Solid	Through coloured	A2,s1-d0	8mm	1192x2500mm 1192x3050mm 1250x2500mm 1250x3050mm	14.2kg/m <sup>2</sup>
Cembrit Transparent	Through coloured	A2,s1-d0	8mm	1192x2500mm 1192x3050mm 1250x2500mm 1250x3050mm	14.2kg/m <sup>2</sup>

# Installation

## Aluminium sub-structure



Cembrit facade boards can be mounted on many different types of support systems. This manual deals with the installation of Cembrit facade boards on an aluminium system. Typically, an aluminium system for fibre cement consists of 'T' profiles at the joints and L profiles as centre profiles. These are vertically mounted on the load-bearing wall using brackets. Insulation is mounted between the profiles on the load-bearing wall. This is the system shown in this installation manual.

Cembrit do not recommend specific systems as there are many suitable suppliers and types of systems on the markets. The system specified should always be selected to suit the type of project as well as being suitable for supporting fibre cement. Contact the Cembrit office in your area for advice on which types that are available in you local market.

### Fixing the support system

Securing the support system to the load-bearing wall must comply with all local standards and regulations as well as follow the manufacturers' recommendations.

Before installing on a load-bearing wall, the installer should check to ensure that wall is flat and true and that the support system can be mounted safely.

Choose the correct fixing system for the load-bearing wall type and material.

The support system and fixings should have the appropriate levels of corrosion resistance for the local environment. Wind load calculations for the facade structure should also be considered and carried out. These calculations will normally be done by a project/construction engineer.

The numbers of brackets, the fixing method, depth and frequency to the load-bearing wall, and the thickness of the aluminium for the support system should be calculated by the manufacturer or by a specialist engineer.

### Support system aluminium performance

Ensure that the performance of the support system used complies with country specific standards and regulations.

When installing on aluminium systems, use rivets to fix the facade boards to the T and L profiles. Cembrit recommends that the aluminium is of minimum 1.8mm thickness.

Maximum aluminium profile length is 3000mm.

# Installation

## Aluminium substructure

To ensure the optimum, long term performance and aesthetic characteristics for Cembrit facade boards it is vital to ensure that the support system substructure is absolutely straight, horizontally and vertically. In order to ensure this, please follow the guidelines below.

If the project is NHBC approved, then there has to be a air gap of minimum 50mm or equal to 500cm<sup>2</sup> per meter. And it is required that the joint is minimum 10mm.

### Straightness of substructure

The horizontal tolerance is +/- 3.0mm measured over a distance of 2 meters

The vertical tolerance is +/- 0.5mm over 600mm measured over a distance of 2 meters.

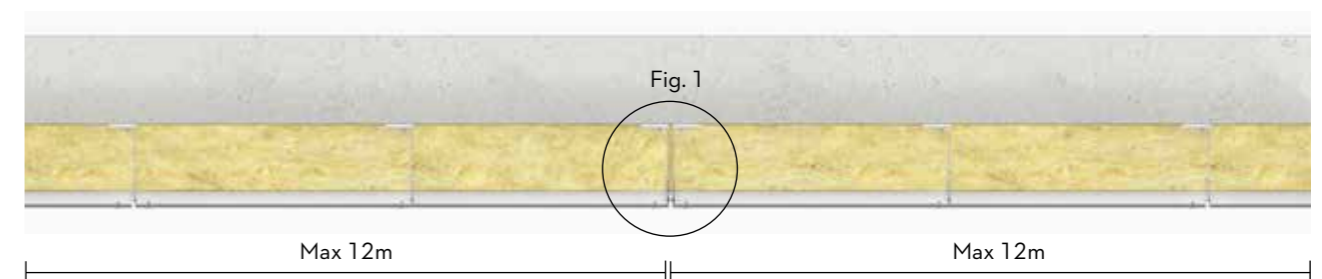

### Movement joints

When installing Cembrit facade boards using aluminium support systems over a large area, the movement of the facade boards and the support system must be taken into account.

Instead of using a T profile at joints, use two L profiles to create a movement joint. This ensures that the two cladding sections can move separately. These joints should be included every 12 meters maximum.

The movement joint gap (between the two cladding sections) should be minimum 8mm.

Fig. 1



# Installation

## Aluminium frame fixing and sliding points

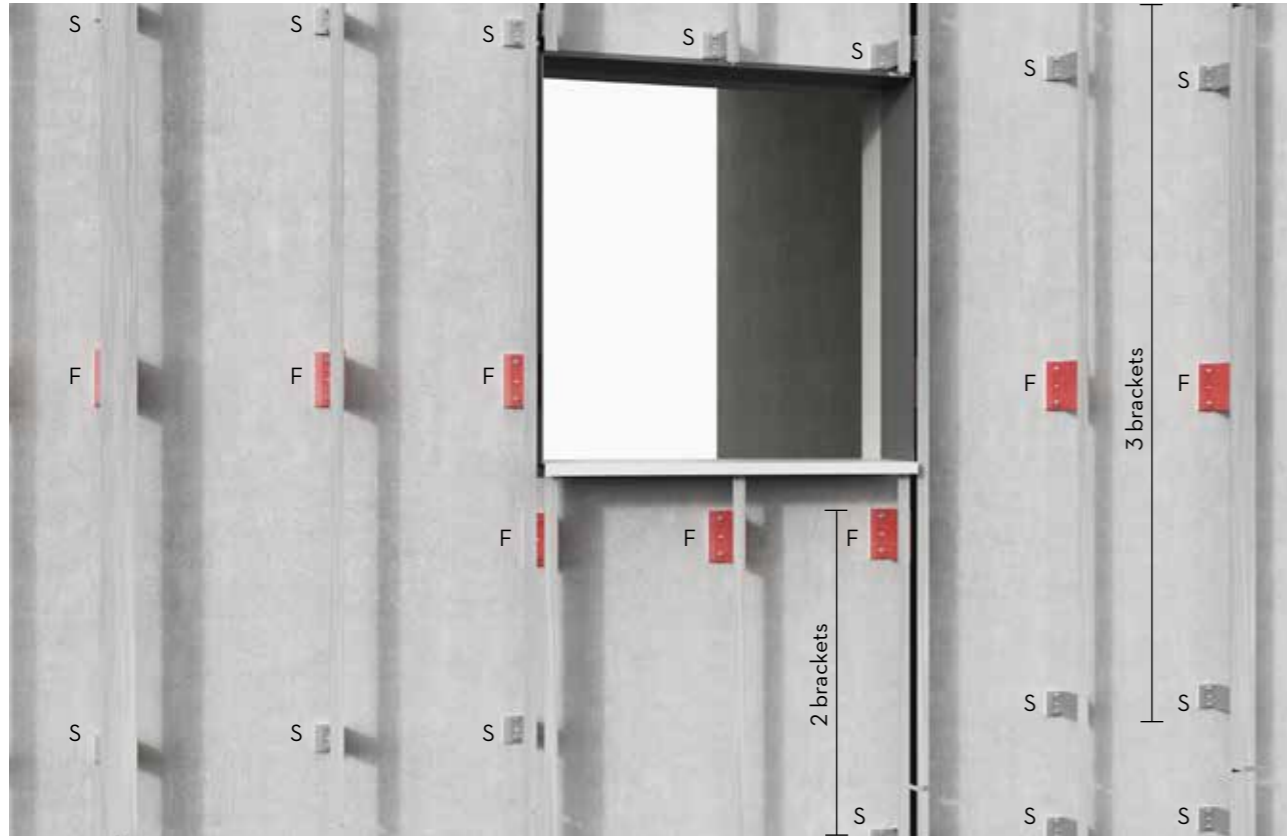

Red brackets are the brackets with fixing points (F)

### Aluminium support system fixing and sliding points

Since the aluminium will expand or contract according to climatic conditions, the T and L profiles should be secured to a 'fixed' bracket.

The remaining brackets should be fixed using the sliding point. This allows the vertical profiles to move up and down as the aluminium expands or contracts.

The fixed bracket should be placed as close to the centre of the T or L profiles as possible so the profiles can move in both directions. The example shown above illustrates a construction where the fixed bracket position is generally in the middle. Only when there are 2 brackets, the fixed bracket should be the top one - so that the profiles can only move from the top downwards.

The example shown above illustrates a construction where the fixed bracket position is in the middle.



Fixing point (F)

Sliding points (S)

# Installation

## Aluminium substructure

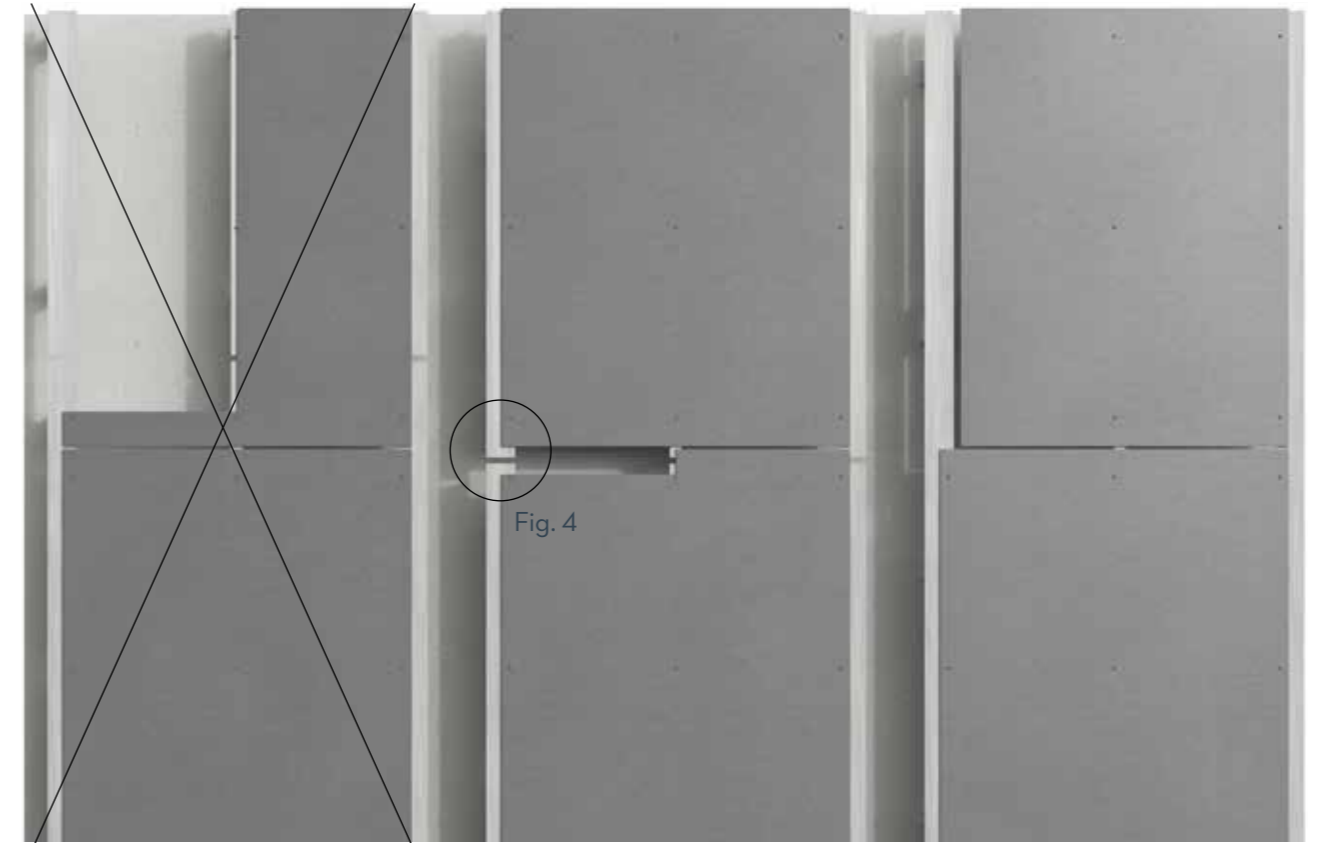

Fig. 1

Fig. 2

Fig. 3

### Correct installation of the aluminium support system

Never install Cembrit facade boards spanning over two or more aluminium profiles lengthwise, as movement of the aluminium and the facade boards caused by moisture and temperature changes potentially could damage the boards (fig. 1).

Cembrit facade boards can either be installed to match the module length of the support system profiles (fig. 2), or smaller format boards can be installed so that several boards span the same profile (fig. 3), provided that facade boards are not fixed to two separate support profiles.

Ensure a minimum 20mm gab between the aluminium profiles (fig. 4)

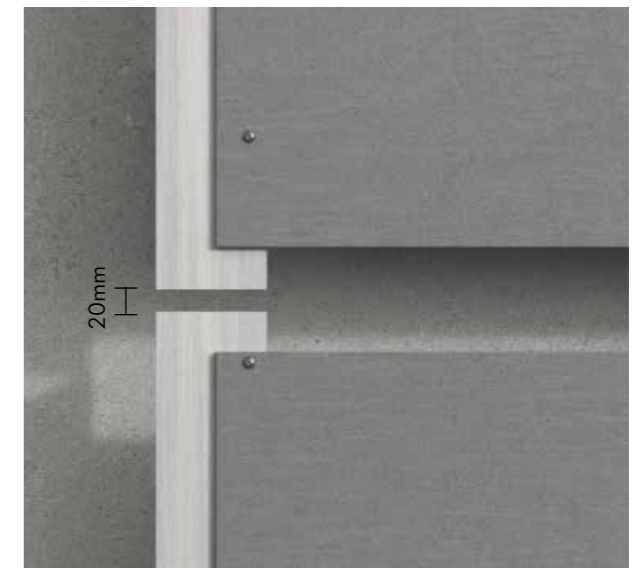

Fig. 4

# Installation

## Edge Distances

### Edge Distances

There should be a minimum of 50mm from the reverse of the facade board to the front face of the insulation to provide adequate ventilation. T profiles behind joints should be min 100mm width, and the L profiles should be min 40mm width. Joint gaps between boards should be min 10mm. The use of flat EPDM on aluminium profiles is optional, but from an aesthetic point of view, it may be advantageous to use it as the aluminium profiles will otherwise be visible through the joints. Alternatively, you can use black UV tape or painted aluminium profiles.

Cembrit facade boards can also be installed on horizontal aluminium systems. When using a horizontal support system, there must be a minimum of 20mm ventilated vertical area between the profiles and the supporting wall or insulation.

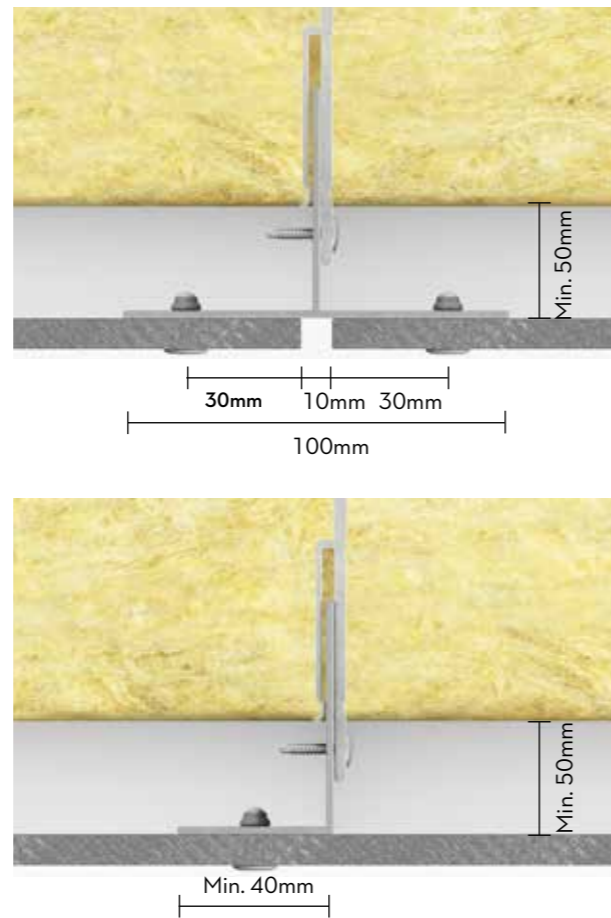

To ensure that boards are able to accommodate movement without damage, please adhere to the following Cembrit guidelines for correct fixing centres and hole sizes. When installing Cembrit facade boards on an aluminium support system, ensure the following requirements are met. Rivet holes should be pre-drilled using a 9mm drill bit (for fibre cement). The position of the corner hole is dependent on the direction of the support system. Fixing distances from the board edge, in the direction of the support system, should be minimum 100mm up to max 150mm. Fixing distances from board side edges should be min 30mm and max 100mm. The illustrations show a vertical support system. If using horizontal support system, the corner distances should be reversed.

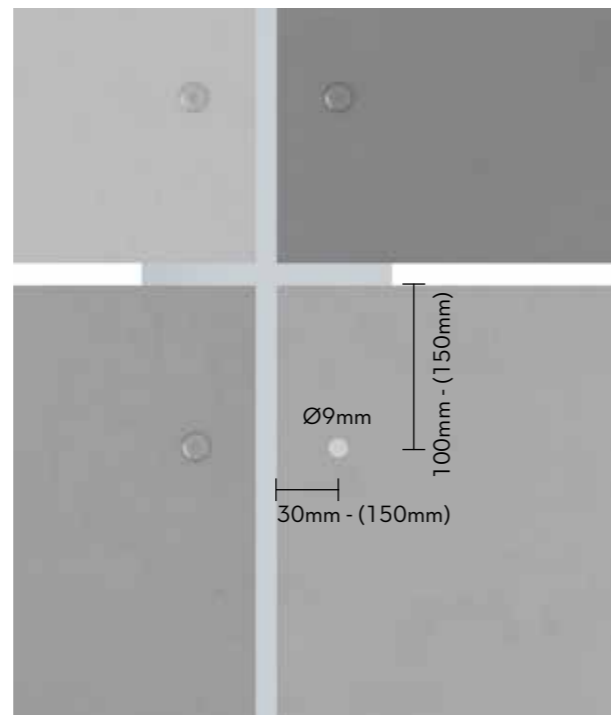

Example of vertical substructure

# Installation

## Aluminium substructure

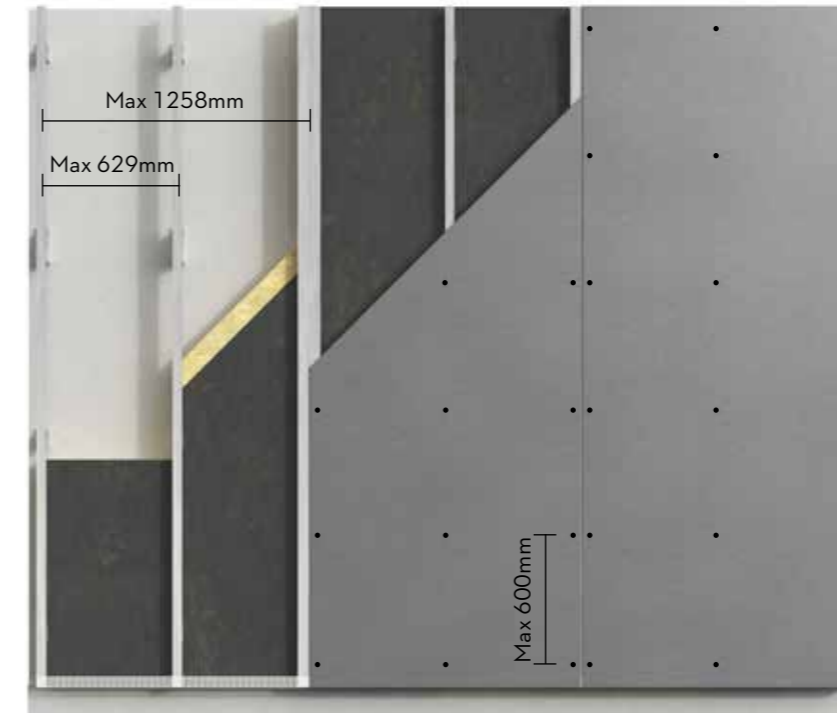

**Aluminium support system  
Mounting 8mm Cembrit facade  
boards on aluminium**

Max. support distances:  
629mm o.c.

Max. rivet centres: 600mm

Max wind load: Please refer  
to the wind load table for the  
correct distances for substructure  
and rivets.

The following rivets types can  
be used for this construction:  
Cembrit Rivets Aluminium RIV-A  
4.0x20mm

# Installation

## Wind load

When installing Cembrit facade boards, consideration should be given to the location of the building and which wind load the boards can be exposed to. In the table below, you find the screw distance as well as the support distances. Combining these two shows how much the board can withstand in kN/m<sup>2</sup>.

It may be necessary to change support spacings/rivet distances at edge zones as the wind loads here may be higher than elsewhere on the building.

### Cembrit Patina Range - characteristic values

Maximum Screw distances mm	Maximum batten distances mm			
	300	400	600	629
300	12.14 kN/m <sup>2</sup>	7.95 kN/m <sup>2</sup>	3.53 kN/m <sup>2</sup>	3.21 kN/m <sup>2</sup>
400	9.11 kN/m <sup>2</sup>	6.83 kN/m <sup>2</sup>	3.53 kN/m <sup>2</sup>	3.21 kN/m <sup>2</sup>
500	7.29 kN/m <sup>2</sup>	5.47 kN/m <sup>2</sup>	3.53 kN/m <sup>2</sup>	3.21 kN/m <sup>2</sup>
600	6.07 kN/m <sup>2</sup>	4.55 kN/m <sup>2</sup>	3.04 kN/m <sup>2</sup>	2.90 kN/m <sup>2</sup>

### Cembrit Cover, Cembrit Solid and Cembrit Transparent - characteristic values

Maximum Screw distances mm	Maximum batten distances mm			
	300	400	600	629
300	13.00 kN/m <sup>2</sup>	7.31 kN/m <sup>2</sup>	3.25 kN/m <sup>2</sup>	2.96 kN/m <sup>2</sup>
400	11.25 kN/m <sup>2</sup>	7.31 kN/m <sup>2</sup>	3.25 kN/m <sup>2</sup>	2.96 kN/m <sup>2</sup>
500	9.00 kN/m <sup>2</sup>	6.75 kN/m <sup>2</sup>	3.25 kN/m <sup>2</sup>	2.96 kN/m <sup>2</sup>
600	7.50 kN/m <sup>2</sup>	5.63 kN/m <sup>2</sup>	3.25 kN/m <sup>2</sup>	2.96 kN/m <sup>2</sup>

The calculations are based on ETAG 034. No additional safety factors have been added. The test on which the calculations are based is made by an accredited laboratory with Cembrits Rivets and the substructure used in the manual. The calculations are also based on the following material of the substructure; aluminium of minimum 1.8mm thickness, aluminium alloys as per EN 573, EN 755 and EN 485 (z.B. EN AW 6063 T66)

If other types of rivets are used, Cembrit cannot vouch for the numbers in the chart. For high buildings or buildings located in exposed areas, there may be a need for specific wind load calculations and simulations, in which case you can contact Cembrit for further information. There may also be situations where additional support and screws are needed in edge zones of the building. The wind load calculation should always be done according to local rules, regulations and the substructure has to be installed correctly as well, so it can withstand the wind load.



# Installation

## Fixing points for Cembrit facade boards

Facade boards must be installed using two fixing positions. These positions should be as close to the board centre as possible and must be aligned horizontally.

All other fixing positions should be sliding points. When installing Cembrit facade boards using rivets, begin with the fixing positions, followed by the sliding points above the fixing positions and finally the sliding points below (see illustration below)

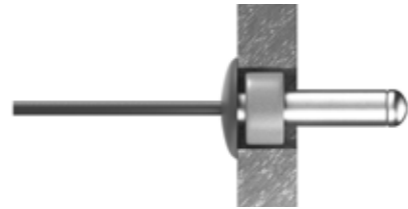

X : Fixing position hole diameter Ø9 mm.  
Insert a Cembrit Fixing Sleeve in the hole before the rivet is fixed.

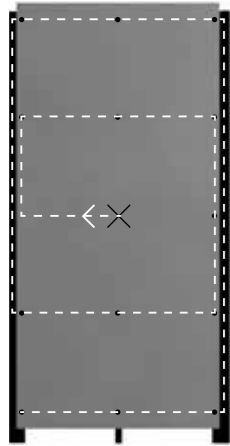
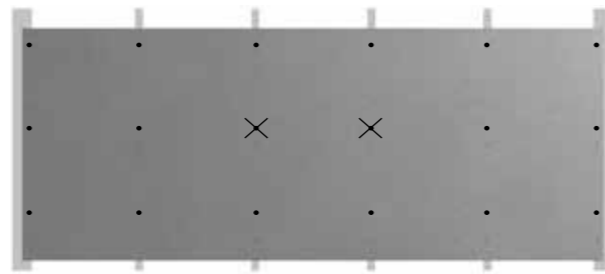
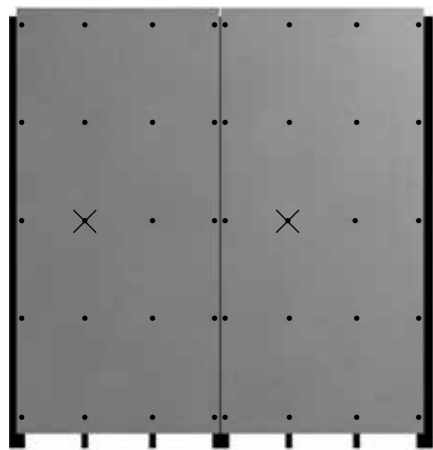

Illustration of correct rivet installation sequence.



Example: Horizontally mounted boards with four intermediate aluminium profiles



Example: Vertically mounted boards with two intermediate aluminium profile

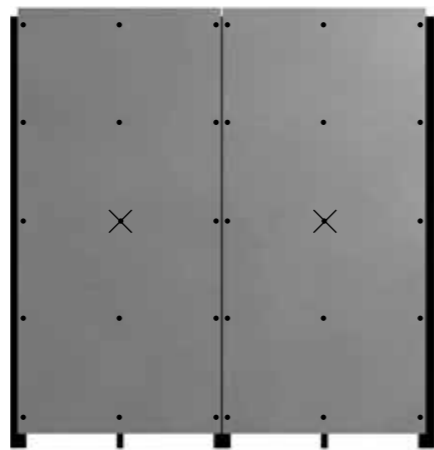

Example: Vertically mounted boards with one intermediate aluminium profile

# Installation

## Cembrit facade boards used as ceiling or soffit

Cembrit facade boards are ideal for use as ceilings and soffits. The solution can be used for both exterior and interior applications.

The boards can be installed on profiles directly mounted to a concrete deck or wooden structure, or they can be used as part of a solution with a suspended ceiling system.

It is possible to change or remove the Cembrit facade boards to access any hidden installations as the boards are mounted using visible rivets.

**Installing 8mm Cembrit facade boards on a aluminium structure - as ceiling or soffit**

Max support distances: 400mm o.c

Max screw centres: 400mm

The edge distances when using Cembrit facade boards as ceiling or soffit are in principle the same as for facade boards in which the direction of the sub-structure and the orientation of the board define the edge distances. This also applies to hole sizes, joints and distances to other building materials.

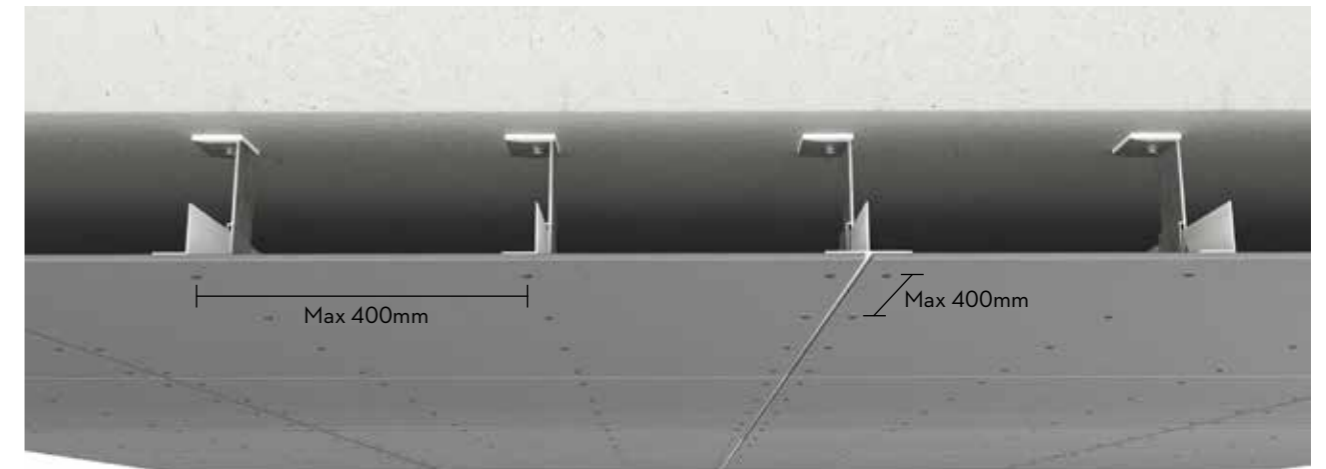

When using Cembrit facade boards as ceiling or soffit, you can normally use a regular aluminium system with brackets and T and L profiles, but for larger cavities, you need to contact an aluminium manufacturer to make sure the system fits your needs. The number of brackets and types of anchoring used for the type of deck/ceiling has to be calculated, and the manufacturer's instructions should always be followed.

# Installation

## Details

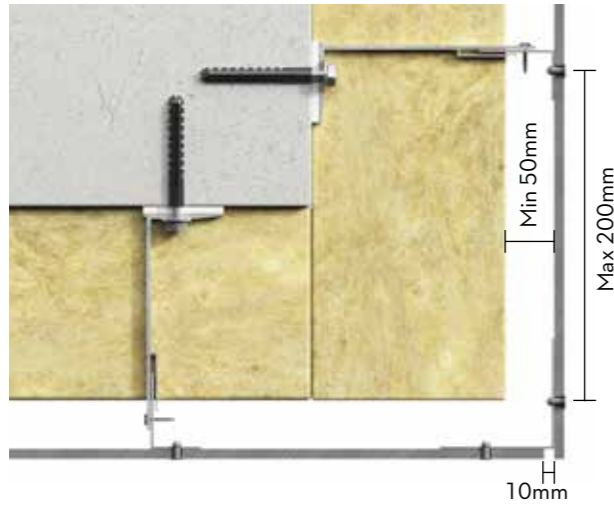

**Horizontal view: External corner construction with open joint**  
 It is possible to create an external corner detail without a Cembrit corner profile. To do this, use an angle profile behind the facade board and fix it with rivets.  
 There should be a min. 10mm gap between the facade boards forming the corner joint. For aesthetic reasons, use a flat EPDM or UV tape to cover the aluminium angle profile.  
 The distance from the corner to the first vertical T or L profile should not be more than 200mm.

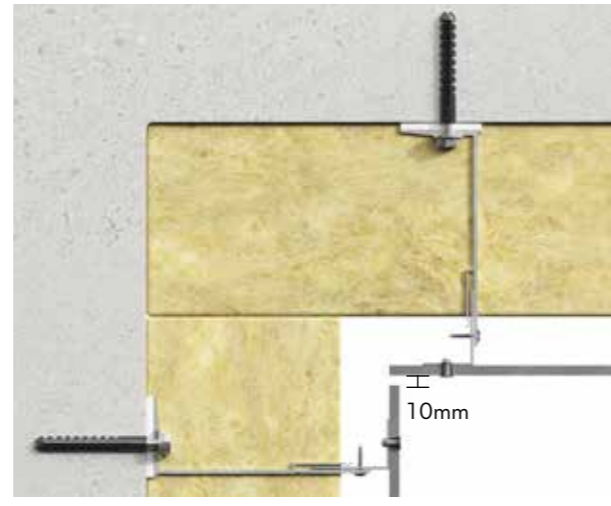

**Horizontal view: Internal corner construction with open joint**  
 There should be a min. 4mm gap between the facade boards forming the corner joint.  
 If using corner profiles behind the boards, Cembrit recommends to use a flat EPDM or UV tape to cover the aluminium angle profile for aesthetic reasons.



**Vertical view: Plinth construction**  
 Ensure that the facade boards project past the base of the support from 10 to 30mm, thereby allowing the water from the facade to run off. Use a ventilation grill at the base of the cladding to ensure that insects and vermin cannot enter the construction behind the facade boards. There should be a minimum free open area of 50mm, or equivalent 500cm<sup>2</sup> per meter.



**Vertical view: Top construction**  
 Make sure that air can move freely from throughout the construction. There should be a minimum free open area of 10mm, or equivalent 100cm<sup>2</sup> per meter to provide adequate ventilation throughout the system. There should be a minimum gap of 30mm between the front face of the facade board and the drip edge of the capping.

# Installation

## Details

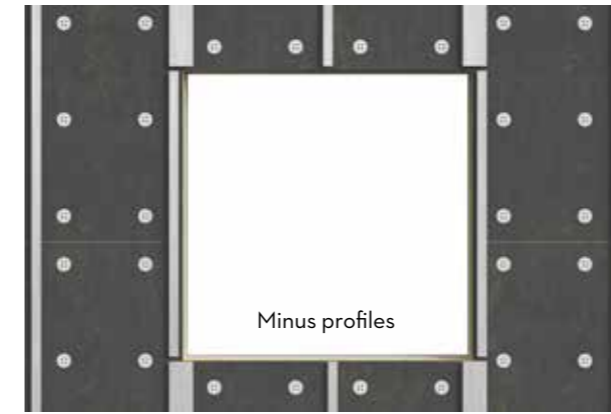

**Front view: Aluminium support systems at window openings**  
 Do not put any horizontal profiles under or over windows as this will cut off the ventilation.  
 To allow for angled sills, ensure profiles are cut to the right length to allow water to run off.

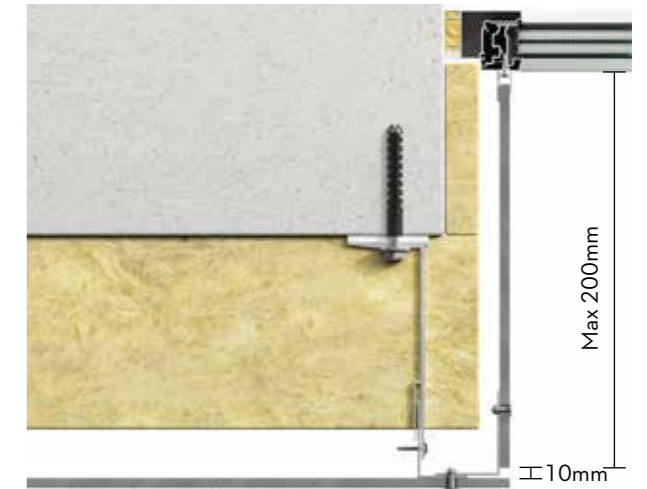

**Horizontal view: Window jambs**  
 Cembrit facade boards can be used for window jambs and returns. Fix facade boards at the corner with rivets through angled profiles. If the jamb depth is less than 200mm, the facade board can be installed using a U profile mounted on the window. If the depth is more than 200mm, insert an additional profile, onto which the jamb board can then be fixed.  
 There should be a min. 10mm gap between the facade boards and the window jambs.



**Vertical view: Window Sill**  
 Cembrit facade boards should not be used as sills. We recommend the use of formed aluminium or steel profiles.  
 It is recommended that the sill projects a minimum of 30mm beyond the face of the facade. There should be a minimum free open area of 50mm, or equivalent 500cm<sup>2</sup> per meter between the top facade board and the sill to ensure adequate ventilation behind the facade.

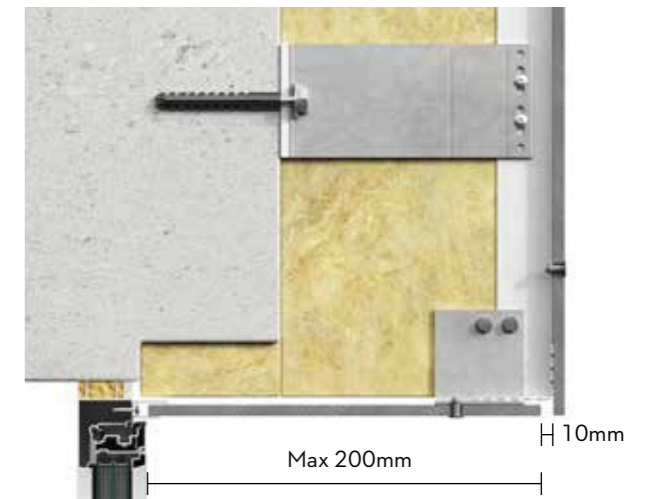

**Vertical view: Window head**  
 As with jambs, the window head can be formed using Cembrit boards. At the front edge of the head detail, ensure a minimum free opening area of 10mm, or equivalent 100cm<sup>2</sup> per meter to ensure adequate ventilation behind the facade. Use a Cembrit Ventilated Profile to ensure that insects and vermin cannot enter the construction behind the facade board.

# Installation

## Cut outs

To avoid cracking of the boards, when installing Cembrit facade boards around windows, doors and other openings, ensure that the facade boards are installed correctly using Cembrit's instructions. Cembrit recommends to avoid cutting single, exact apertures in boards, but instead you should cut smaller sections and install them individually. Cut the boards and make vertical joints of 8mm. Make sure that there is support behind the joints, onto which the facade board can be mounted.

If the small cut outs are not wider than 100-150mm, they can be mounted with only one rivet in the middle of the board (a). This also applies when using the Cembrit facade boards in other solutions on a building as window jambs or in connection with other narrow spaces.

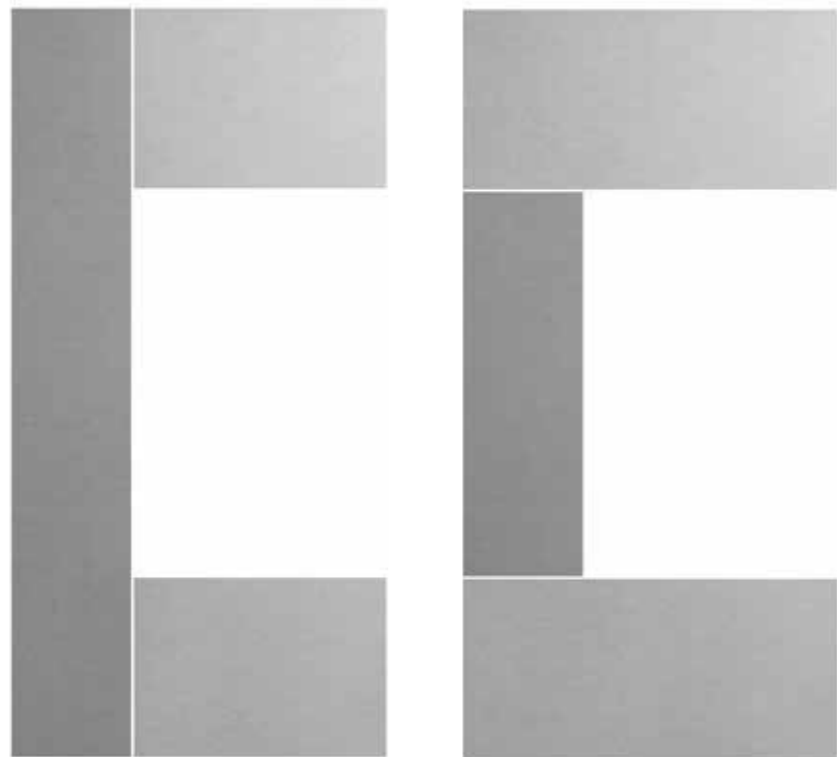
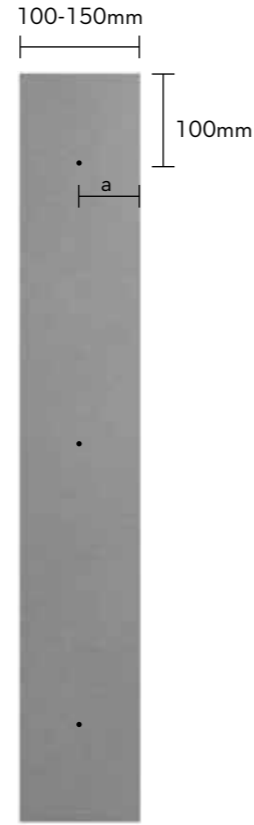

Correct installation of Cembrit facade boards at windows, doors and openings.

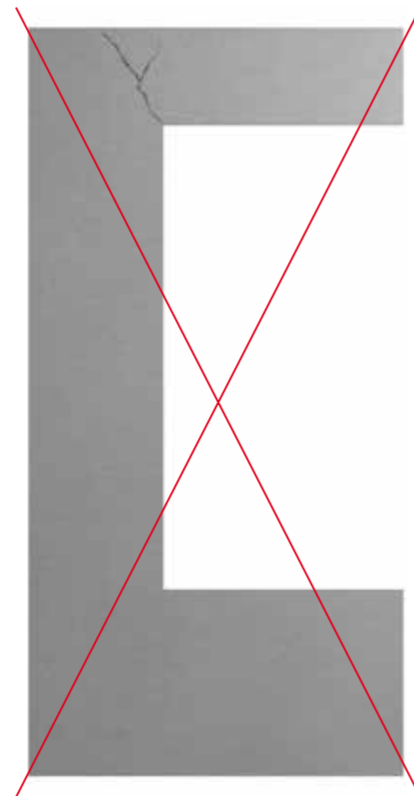

Incorrect installation of Cembrit facade boards at windows, doors and openings.

# Installation

## General distances

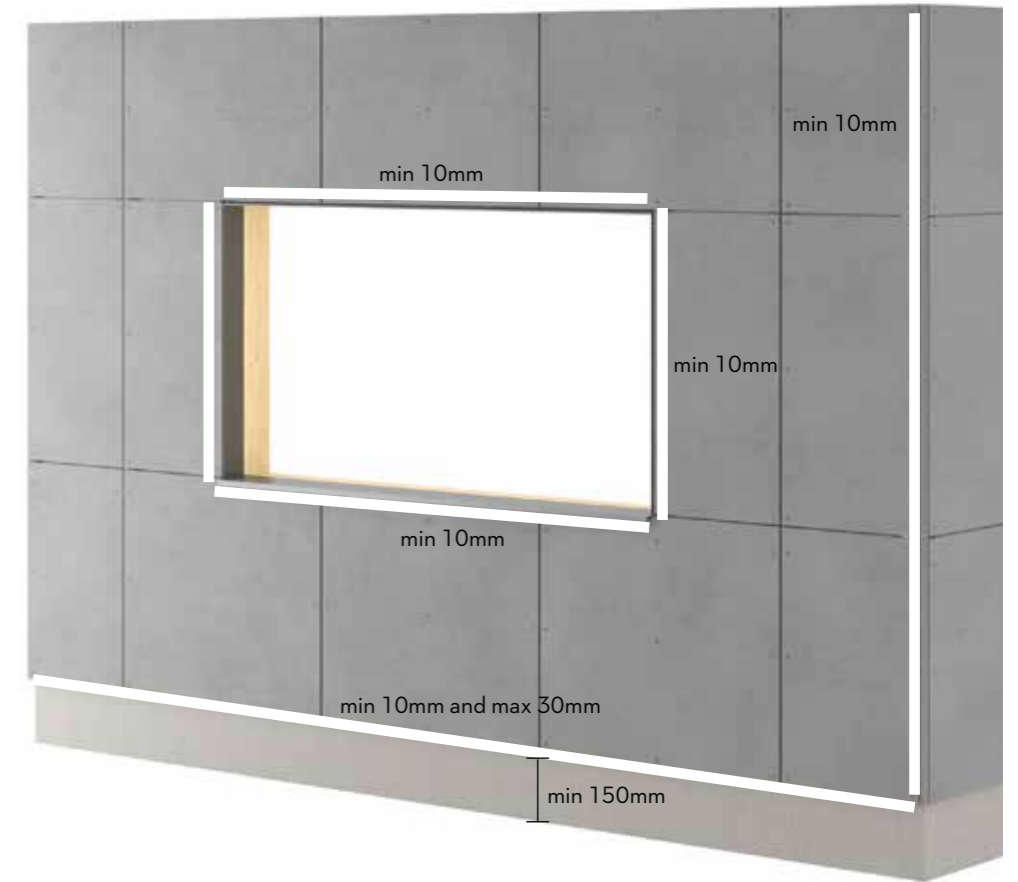

Make sure to follow the guidelines regarding distances described in this manual. The facade board should finish between 10 and 30mm below the bottom end of the substructure. For overhang and similar, the maximum distance is 100mm.

The distance to terrain from the bottom edge of the facade board should be a minimum of 150mm. The distance to flat roofs, balconies and other horizontal structures, where the water can drain away, should be a minimum of 50mm.

Vertical clearance to profiles such as Cembrit Alu Trim or Cembrit Corner profile should be minimum 10mm. For horizontal clearances at windows and doors etc., you must leave a minimum of 10mm for ventilation.

The clearance to other building materials should be minimum 8mm for movement and water drainage.



# Accessories

When fixing Cembrit facade boards using aluminium, use purpose-designed accessories. In general, using appropriate tools will achieve the best installation.



**Cembrit Rivets Aluminium**  
RIV-A EPDM Washer 4.0x20mm  
Aluminium body and Stainless steel mandrel. Unpainted or colour coated to the facade boards  
Grip Range 11-15mm



**Cembrit Fixing Sleeve**  
Sleeve for Alu Rivets 4.1x5.5x8.8mm  
Nylon grey



**Tool Box Aluminium**  
1. Centralizing Tool for aluminium  
2. Stand-off Head  
3. 2 Pcs. HSS Drills 4.1mm  
4. TCT Drill 9mm



**Centralizing Bit Drill**  
4.1/8.5-9mm



**Cembrit Edge Sealer**  
0.25ml  
(Not for Cembrit Patina)



**Cembrit Nose tool**

## Cembrit Blades

For cutting Cembrit facade boards, the following blades can be used.

Diameter	Ø160	Ø190	Ø216	Ø250
Thickness mm	2.2/1.6	2.2/1.6	2.2/1.6	2.6/1.8
Centre hole mm	20	20	30	30
RPM	4800	4000	3500	3000
Teeth	6	4	6	14



# Accessories

## Rivets

### Rivets for Cembrit facade boards

Use Cembrit Aluminium Rivets  
RIV-A EPDM 4.0 x 20mm

Use Cembrit Fixing Sleeves at the fixing positions - see page 16.

### Installing Cembrit facade boards using rivets

Before installing the boards, pre-drill holes in Cembrit facade boards using a Ø9mm drill.

Dust from cutting or drilling must be removed with a brush or compressed air immediately after the work has been completed, otherwise it can mark the surface of the boards.

Before drilling the holes in the aluminium profiles, place the facade board in its intended position on the aluminium structure. You can hold the board in place using locking pliers or use a supporting board below the facade board.

### Centralising tool

Position the centralising tool through the pre-drilled hole in the board to ensure accurate fixing hole positions in the aluminium profiles that perfectly match the board's hole positions. Use an 4.1mm HSS Drill for drilling fixing positions in the aluminium.

Alternatively, a Centralizing Bit Drill can be used.

For the fixing points, you must insert the rivets into the Cembrit Fixing Sleeves and install them at the fixing positions of the board.

All other rivets are installed without the fixing sleeve to allow the boards to move freely in the sliding points.

The Stand-Off Head must be used for all rivets. This provides a small space between the board and the rivet head to allow for movement caused by moisture or temperature changes.

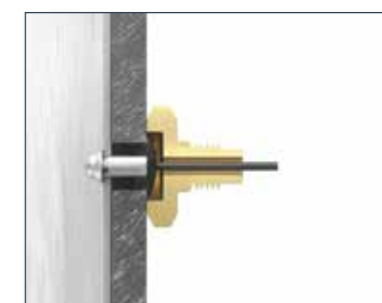
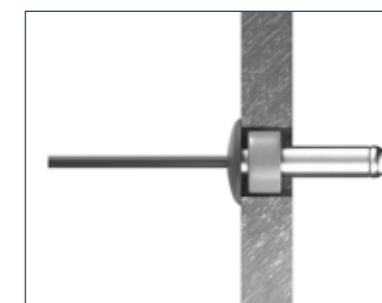
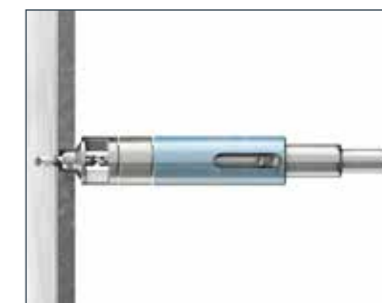
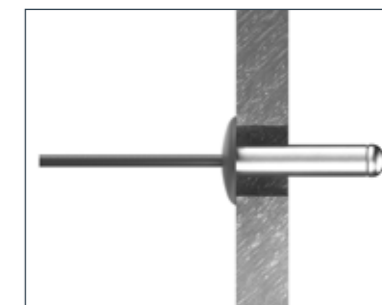

# Accessories

## Edge Sealer

Cembrit Edge Sealer should be used to protect all edges of fibre cement boards when cut on-site. Factory-cut edges are always factory pre-sealed. Only Cembrit Edge Sealer should be used on Cembrit products (Cembrit Cover, Cembrit Solid and Cembrit Transparent).

### Before treating the surface

The boards must be dry and edges clean and free from dust and dirt before applying the Edge Sealer. It is useful to roughen the edges with sandpaper (grade 80). Edges must be sealed immediately after cutting.

### Application conditions

Board and air temperature should be between + 5°C to + 30°C and relative humidity should be below 85%.

### Application

If application is not to be carried out in a well ventilated room or outdoors, use respiratory equipment. Wear goggles and gloves while applying Edge Sealer as set out in the the safety data sheet.

If there is sticky foil on the board, leave it in place until the Edge Sealer has dried.

Shake Edge Sealer before use. Apply it in a thin layer with the sponge applicator supplied in the Cembrit Edge Sealer set.

Avoid getting excess Edge Sealer on board faces. If this does occur, remove immediately with a lintfree cloth.

Ensure that the entire edge has been sealed with a thin layer before continuing to the next edge. Apply Edge Sealer to individual boards separately, not while stacked.

### Disposal

Disposal of Cembrit Edge Sealer should be done in accordance with local and national regulations.



**Cembrit Edge Sealer Set**  
0.25 ml Sealer  
Applicator  
Sponge

# Accessories

## Cembrit Blade

To ensure a neat finish when cutting Cembrit facade boards, it is important to use the correct blade. Cembrit recommends using Cembrit Blades as they have been customised for the purpose and leave you with the best end-result.

The blades have trapezoidal diamond teeth which provide excellent cutting quality and extremely long durability. In addition, the amount of dust generated is significantly reduced compared to similar blades. The Cembrit Blade is available in 4 sizes depending on which saw is used.

The Cembrit blade can be used with dive saw, circular saw and stationary circular saw.

The Cembrit Blade is a high quality product that can be sharpened, thus improving asset cost efficiency.

To achieve the best quality cut and to know which side to cut from, make sure to follow the instructions shown here. The direction varies depending on which saw you use.

### Handling

When cutting the facade boards, do not force the sawblade through the board. If you force the saw, the blade might overheat causing small vibrations - affecting the straightness of the cut or causing the board to flake if near the edges.

It is important to remove dust caused by cutting and drilling immediately either with a soft brush or a vacuum cleaner as it otherwise might damage the boards. Ensure that the boards are properly cleaned before installation, and if necessary use clean water, or water with a mild detergent and a soft sponge, or brush to remove dirt and dust from the surface.

Local requirements regarding safety must always be followed. Make sure to use correct safety equipment such as masks and dust ventilation and ensure that the saw is set up correctly according to the manufacturer's instructions.

Never use water when cutting Cembrit facade boards.

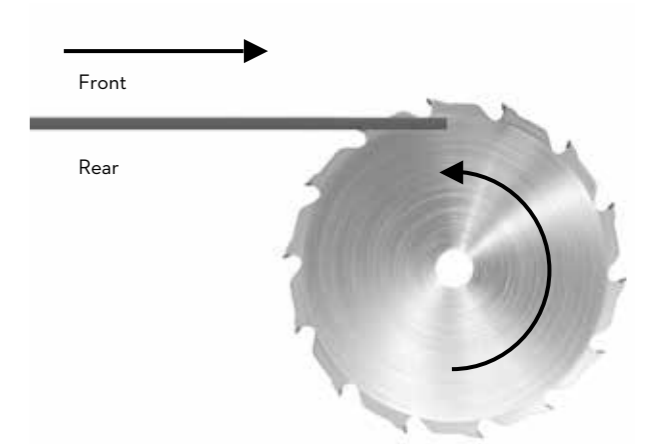

When using a table saw, place the board with the face uppermost on the table and cut from the rear of the board.

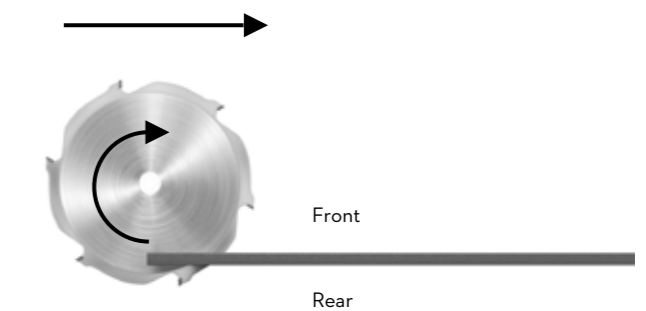

When using a mitre saw, cut the board from the front.

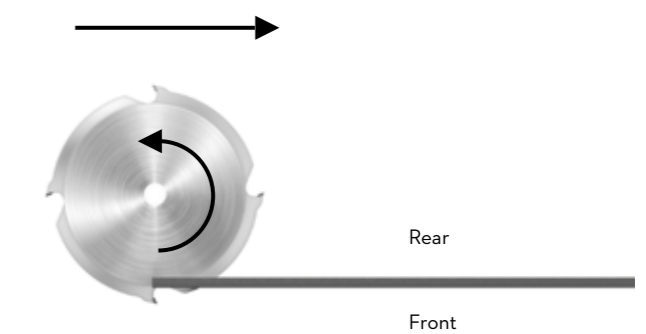

When using a circular saw or dive saw, cut the board from the rear.

# Profiles

Cembrit offers a wide range of profiles to create weathertight and aesthetically pleasing facades. All Cembrit Profiles are available in a variety of standard or special colours - either pre-painted or powder coated.

The profiles are fixed using double sided tape and will be further fastened as the boards are installed using rivets.



One way to create an aesthetically pleasing solution, is to use the Cembrit corner profiles as shown here. As the other profiles, the corners profiles are available in a variety of colours to match your facade boards.

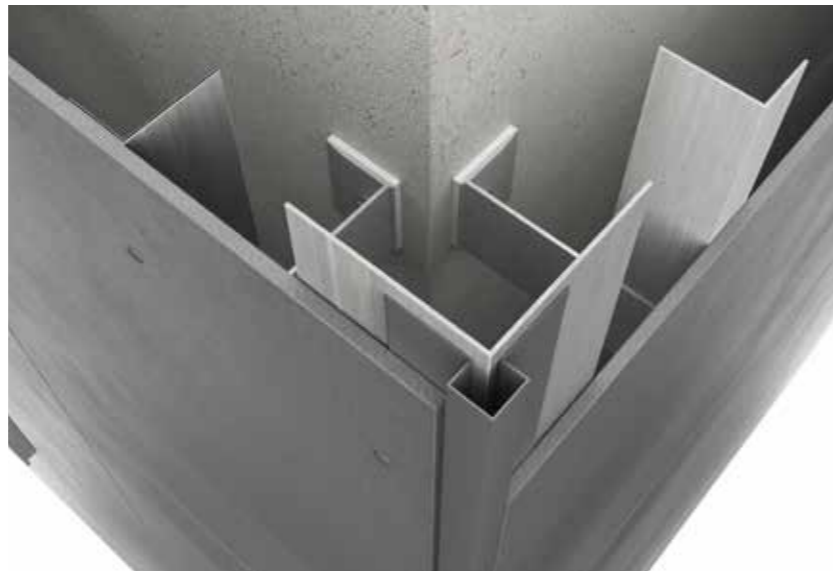

# Profiles

Most Cembrit profiles are fabricated from 1mm thick formed aluminium. For standard boards, the profiles are pre-coated formed aluminum which has a gloss 30. For non-standard colours, the profiles are unpainted formed and powder coated aluminium with a paint of gloss 70. The profiles in standard colours are protected with a sticky foil.

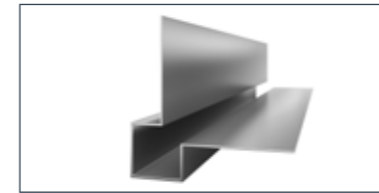

**1. Cembrit External Corner Small**  
Length 3000mm



**2. Cembrit External Corner Peak**  
Length 3000mm

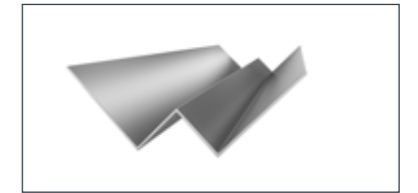

**3. Cembrit Internal Corner**  
Length 3000mm



**4. Cembrit Caulking Profile**  
Length 3000mm

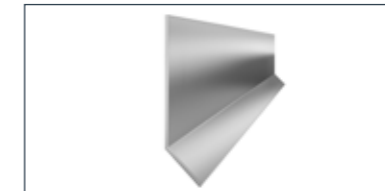

**5. Cembrit Horizontal L Profile**  
Length 3000mm



**6. Cembrit Drip Small**  
Length 3000mm



**7. Cembrit Ventilated Profile**  
0.6 mm white perforated steel  
Length 3000mm

# Profiles

## Profile Use

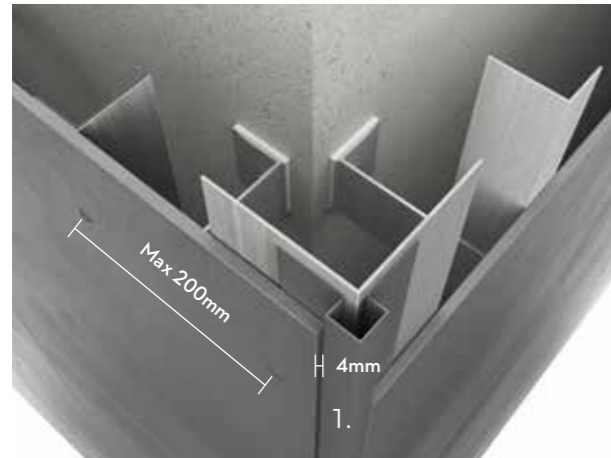

Cembrit External Corner Small is used for 90° external corner constructions, to create a securely finished detail. Use double sided tape to temporarily fix the profile to the facade board before fixing it with rivets. Make sure the correct edge distances and hole sizes are used. The distance from the corner edge to the wall T or L profile should not exceed 200mm. There should be a minimum 4mm gap between the board edge and the profile.

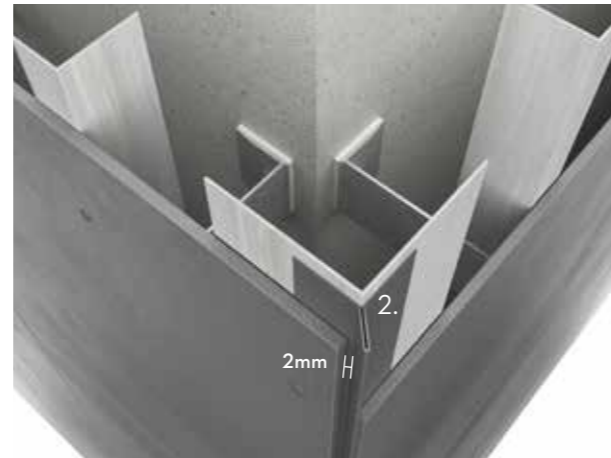

Cembrit External Corner Peak can also be used for 90° external corner constructions. It is installed in the same way as Cembrit External Corner Small. The distance from the inside edge of the facade boards to the profile should be a minimum of 2mm.

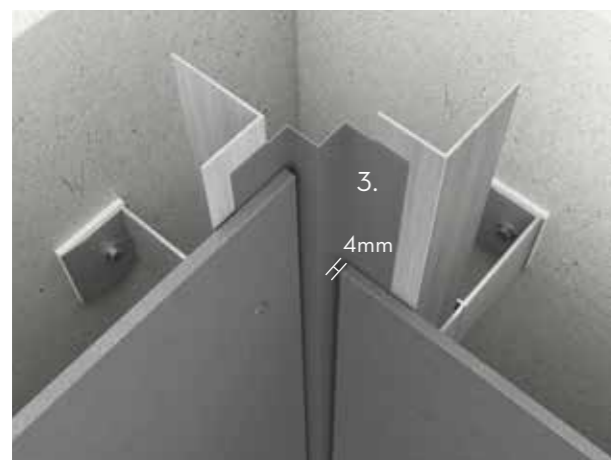

Cembrit Internal Corner is used for 90° internal corners. Secure the profiles with double sided tape. Once fixed, the facade board will secure the profiles in position. There should be a minimum 4mm gap between the board edge and the profile.

# Profiles

## Profile Use



Cembrit Drip Small is used to drain water away from the supporting structure or where neat detailing is required at the foot of the facade. The profile can be used in conjunction with Cembrit Ventilated Profile to ensure that insects and vermin cannot enter the cavity behind the facade boards. There should be a minimum 4mm gap between the board edge and the profile.

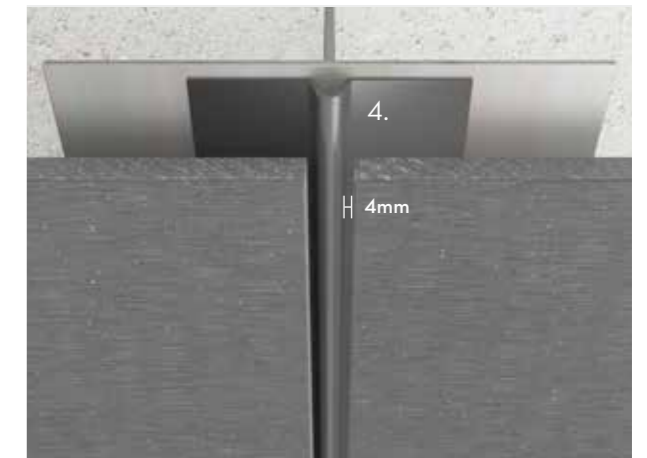

Cembrit Caulking Profile can be used in both vertical and horizontal joints. It is not mandatory to use Cembrit Caulking Profile, but it provides excellent joint solutions. The profile is installed in the same way as Cembrit External Corner. There should be a minimum 4mm gap between the board edge and the Cembrit Caulking Profile.



The Horizontal L Profile used for horizontal joints should be cut in the same length as the width of the facade board.

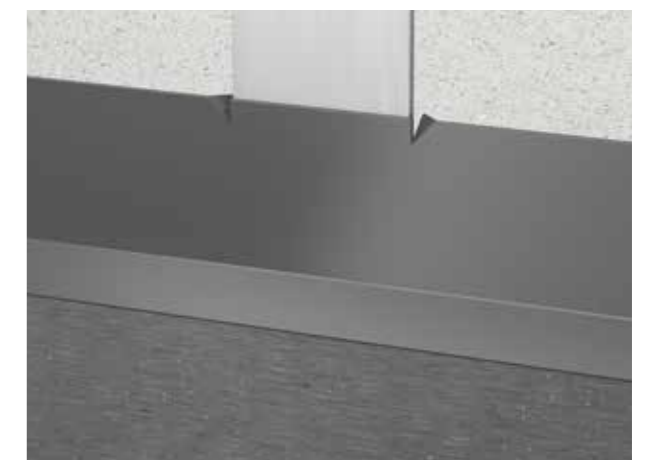

When installing Cembrit vertical profiles, it may be useful to cut and fold out a triangle on each side of the L profile, as shown in the illustration. This will prevent the horizontal profiles (Alu-L profile) from moving.

# Onsite Handling

Cembrit facade boards are supplied with a polyethylene foam layer between each board to prevent scratching and damage to the surface. The polyethylene is an environmentally friendly polymer that can be disposed of as normal combustible waste.

On Cembrit Cover and Cembrit Solid boards will in some cases be a protective foil applied on the surfaces. This foil is a stikki foil Which does not fall off when handling the boards. Use the foile to make marks on for the holes for the screws ore rivets. Pre-drill trough the foil.

Just before installation of the board remove the foil. Do not wait with removing the foil to after screw or rivets are fitted.



When marking the boards, make sure that marks are no larger than the hole to be drilled or no thicker than the blade that is to cut the board, as it can be difficult to remove marks from the board afterwards.

Once boards are cut, you can bevel the cut edge with a fine grinder (80 grain) to give the edge a pre-cut finish. The bevel should be angled at 45° relative to the board. This retains edge strength and removes small irregularities.

If not using Cembrit Facade Wing Screws, the boards should be pre-drilled with an appropriate fibre cement drill bit. Dust from cutting or drilling must be removed with a brush immediately after the work has been completed, otherwise it can mark the surface of the boards.

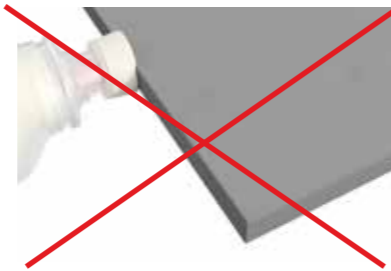
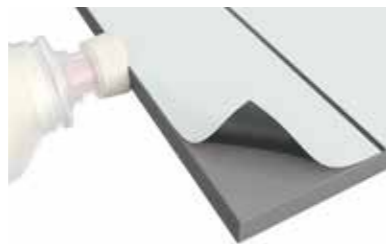

All cut edges (except Cembrit Patina) must be sealed with Cembrit Edge Sealer to ensure protection of the cut edges. Use the Cembrit Edge Sealer Set with Applicator and Sponge. Avoid getting Edge Sealer liquid on board faces. If this does occur, remove any liquid with a lint-free cloth immediately.

If there is sticky foil on the board surface, it is advantageous to keep it on when sealing edges. It can also be used to make marks for holes and cutting. Remember to remove it before installation.

Cembrit Patina edges should NOT be sealed with Cembrit Edge Sealer.

# Storing and Handling



Cembrit products are delivered with plastic protection cover. If undamaged, the plastic cover provides good protection against dust and weather conditions during transportation. Always store Cembrit products on a flat dry level surface.



Only two pallets must be stacked on top of each other. Make sure they are positioned so they stand securely and stable.



If the pallets are stored outside when they arrive at the building site, the plastic cover should be removed. The facade boards should be stored on the pallet or sleepers with max 500mm distances.



Replace the plastic with a tarpaulin. It is very important that there is ventilation all around the tarpaulin and also on top of the pallet under the tarpaulin. This is done to make sure that condensation is reduced as much as possible.

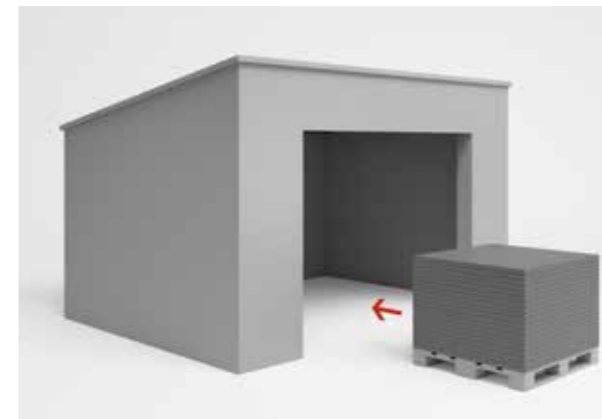

If Cembrit facade boards are stored more than 2-3 weeks on site, the pallets should be kept under a roof to ensure dry and ventilated conditions.

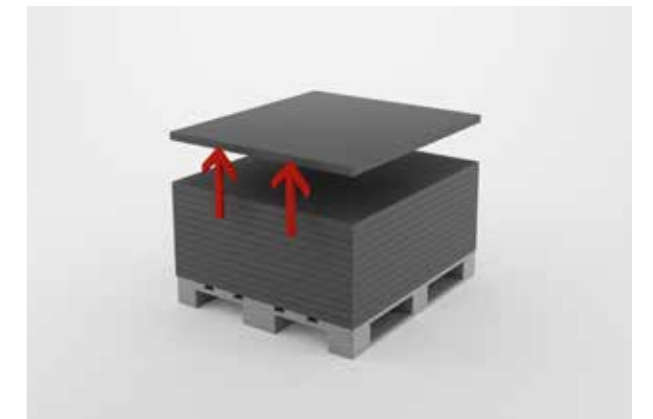

Do not drag products from the pallet, as it may leave permanent scratch marks. Lift the product by its narrow edge as it may break if handled incorrectly.

# Care & Maintenance

## On-site

### Cleaning of boards after cutting and drilling

It is important to immediately remove dust caused by cutting and drilling from the front and rear of the boards with a soft brush/duster or a vacuum cleaner, as it otherwise might damage the boards. Ensure that the boards are properly cleaned before installation, and if necessary use clean water or water with a mild detergent and a soft sponge or brush to remove dirt and dust from the surface. Thereafter, wipe the boards with a damp cloth. It may also be necessary to wash the surface after installation if the building site conditions have been unfavourable. This is done with lots of clean water or water with a mild detergent and a soft sponge or brush and finally wiping the boards with a damp cloth.

### Removal of calcium-based residues

Calcium carbonate residue may occasionally be seen on the board surface. This can be difficult to remove with water or even with detergents because it does not dissolve in water. For cleaning purposes 10% acetic acid (CH<sub>3</sub>COOH) solution is used to dissolve the calcium compounds.

**Note!** Carefully observe safety precautions (MSDS) when working with acetic acid. R-phrase R36/R38 is valid: "Irritating to eyes, respiratory system and skin". Use proper clothing, nitrile rubber gloves, eye protection goggles and approved respirator (filter A, E or A/E).

Carry out the mixing outdoors. Apply the diluted 10% acetic acid solution evenly with a spray can to the surface of the stained board. Leave it to react for a few minutes. Do not allow the solution to dry, but rinse with lots of clean water. Repeat the process if necessary and rinse with water afterwards.

**Note!** Do not execute the cleaning process with acetic acid in direct sunlight or on hot surfaces. This might create permanent stains.

### Cleaning of neighbouring areas

Windows and glass in particular but also other adjacent areas must be kept clean during the facade

board installation and if necessary protected with plastic film. Alkaline leaching from cement bonded materials (dust from cutting or drilling holes in structural concrete, etc.) is prone to damaging glass and other materials. Therefore, frequent cleaning during and after the construction period is needed.

### Surface damages and scratches

Damages and scratches should be avoided by lifting the boards off the pallet and handling them carefully during installation. Scratches might leave white streaks on the surface which will turn dark when exposed to rain, because the board absorbs water through the scratch. Repair paint is not available. The only way to prevent dark stripes or spots is to carefully apply clear Cembrit Edge Sealer onto the scratch with a thin brush (does not apply to Cembrit Patina). In any case the dark area will diminish after 6 to 12 months, because of the carbonation reactions in the cement matrix of the board.

### Wet framing/wet spots around screw holes

The principles for scratches also apply to cut edges: Carefully apply Cembrit Edge Sealer according to Cembrit instructions. Cembrit screws and rivets are supplied with sealing washers negating the need to seal pre-drilled fixing holes. When properly installed, the sealing washers will prevent water penetration into drill holes.

### Behaviour in wet conditions

Since the boards are made of Portland cement, their colour may turn darker when exposed to rain if the board absorbs moisture through holes, scratches or insufficiently sealed edges. This is natural behaviour for any cement-based product and it does not affect the integrity or long-term durability of the board. The original colour is restored as soon as the boards dry out. The darkening will show after heavy rainfall for the first months after installation. It will gradually reduce within 6 to 12 months, because the cement-based matrix reacts with carbon dioxide from the atmosphere – carbonation – and thereby reduces water penetration.

# Care & Maintenance

## After installation

### Annual Inspection

Normally Cembrit facade boards do not require any maintenance. Weathering may however influence the appearance of the facade. Therefore, an annual inspection of the ventilation gaps, joints and fixings is a good idea.

Detection and repair of possible damage ensures a prolonged lifespan for the facade.

### Cleaning

Cembrit facade can be cleaned with cold or luke-warm water if necessary with the addition of a mild household cleaning agent not containing solvents. Always start from below with well-defined areas. Rinse with plenty of clean water until the facade is perfectly clean. Before cleaning full scale, it is recommended to test the chosen cleaning method on a smaller area to ensure it works and does not damage the board surface.

### High-Pressure Cleaning

Warning! High Pressure Cleaning is a severe treatment for fibre cement facade. Exaggerated or wrong use of a high pressure cleaner may damage the surface. Therefore, High Pressure Cleaning is not recommended.

### Moss & algae

Moss and algae growth can be removed with common agents available on the market. Care should be taken to ensure that the cleaning agent does not cause damage to the surface of the Cembrit facade boards. Confirm the compatibility of your cleaning agent with your cleaning agent supplier, and ensure it is applied according to the supplier's instructions. It is advised that before conducting a large-scale application a test is carried out on a small, inconspicuous area to ensure that the cleaning agent has no effect on the colour of Cembrit facade boards.

### Efflorescence

Efflorescence is a naturally occurring, white, powdery deposit that can appear on cement-based building materials (including bricks, cement walls, grout, and fibre cement). It is the result of a process in which moisture draws salt crystals to the surface, evaporates, and leaves a chalky substance behind. Efflorescence occurs when all three of the following conditions exist:

1. Water-soluble salts are present in the building material.
2. There is enough moisture in the wall to turn the salts into a soluble solution.
3. There is a path for the soluble salts to get to the surface.

Efflorescence may also be a sign of water ingress behind the facade. Make certain that all openings are properly covered and there is no water intrusion due to over-driven nails.

While some efflorescence may weather away naturally on its own, it is best to take steps to treat it. Efflorescence can be removed with household white vinegar and water. For most cases of efflorescence, Step 1 - 3 works well. But for substantial deposits of efflorescence go to Step 4.

For best results, follow these cleaning instructions:

1. Protect areas that are not to be cleaned. Rinse all plants and vegetation around the facade with water before and after application of the vinegar.
2. Generously coat the entire surface area with vinegar. Allow the solution to sit on the surface for 10 minutes.
3. Rinse the treated area thoroughly with water from the top down and allow the area to air dry.
4. For extra tough efflorescence: Use a 10% acetic acid solution and apply to affected area with a cotton cloth. A light scrubbing with the cotton cloth may be required. After about 20 seconds rinse with water.

# Health and Safety

As with all building materials, safety precautions must be taken into account and local laws and regulations must be observed.

## Cutting and drilling

When cutting, grinding or drilling, dust from the fibre cement boards is released. This dust is characterised as mineral dust. Breathing large amounts of dust may cause irritation to respiratory functions, eyes or skin. Therefore, Cembrit always recommends wearing personal protection equipment or stated by local law (Safety goggles, safety suit and a respiratory mask - P2 marked).

When cutting Cembrit facade boards ensure adequate ventilation.

If the boards are cut indoors, it may be necessary to use an extractor system or a HEPA filter vacuum attachment attached to the power saw. When cutting outdoors, you should also use a HEPA filter vacuum attachment to the power saw. If ventilation is not adequate to limit exposure, wear a disposable respirator or air purifying cartridge respirator fitted with a Class P2 filter (European EN 143 standard). To reduce exposure to dust, Cembrit recommends using Cembrit Circular Blade.

## Lifting Cembrit facade boards

When lifting Cembrit facade boards, please consider your lifting methods both in terms of safety but also to avoid damaging the boards.

When lifting or moving the facade board, please make sure to lift the board by its narrow edge as it may otherwise break if handled incorrectly. If lifting Cembrit facade board manually, make sure to adhere to any local rules. When lifting large boards, use mechanical lifting gear if possible. If this lifting gear uses suction/vacuum, be careful not to apply too much suction, as this may damage the surface or leave permanent marks.

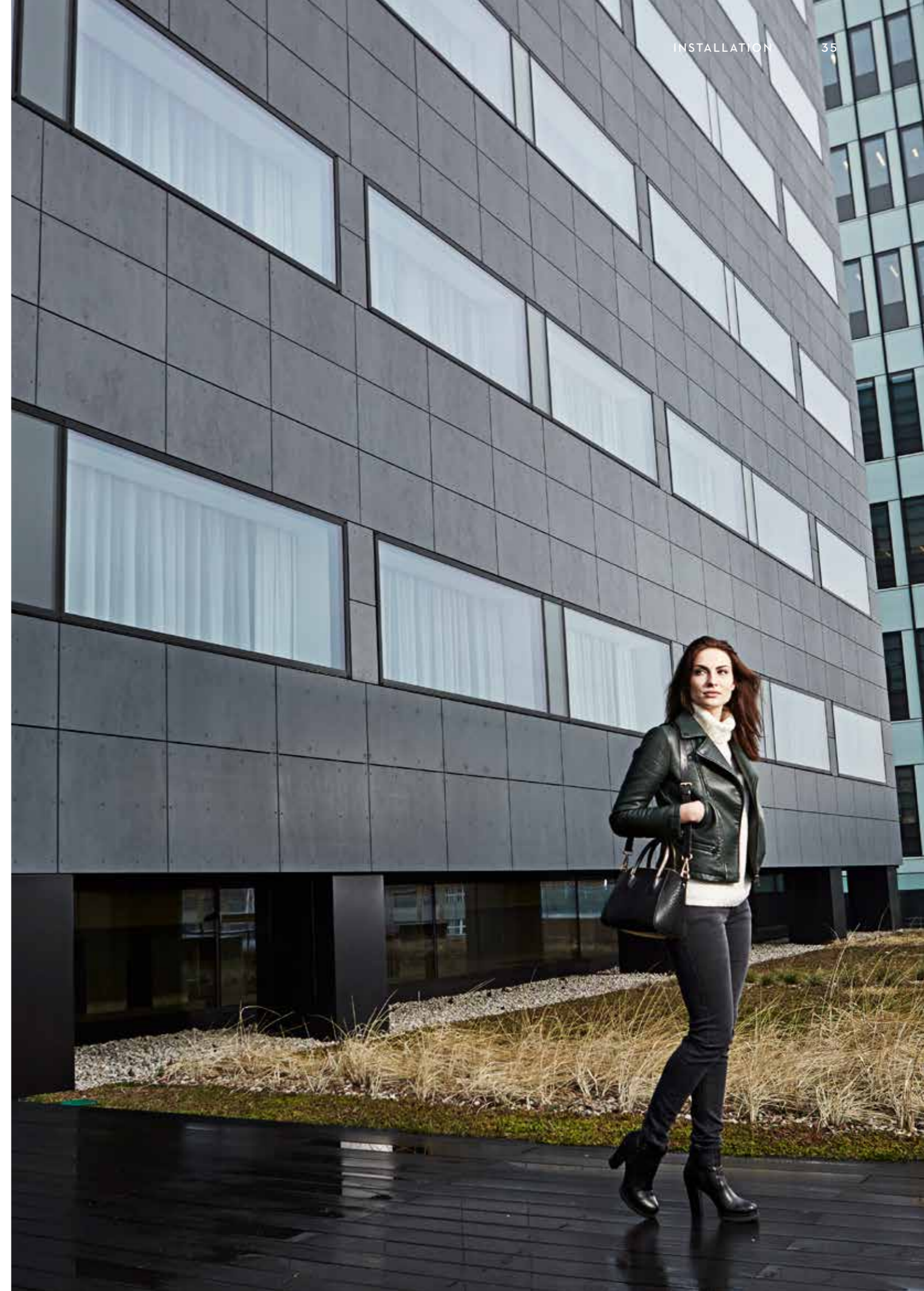
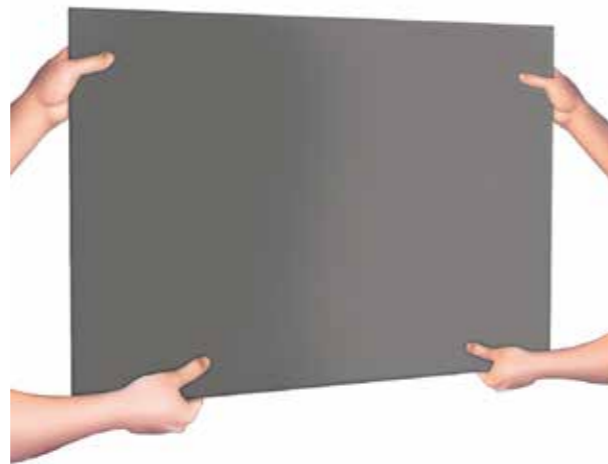
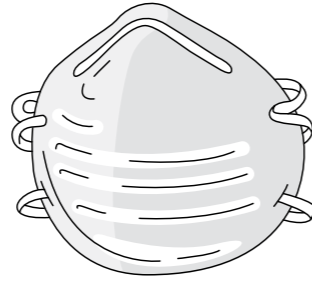

# CENBRIT

Cembrit Ltd  
Studio 39, Thames Innovation Centre, 2 Veridion Way, Erith, Kent DA18 4AL

[info@cembrit.co.uk](mailto:info@cembrit.co.uk)  
[www.cembrit.co.uk](http://www.cembrit.co.uk)