



# Washrooms for education



From  
Nursery...

...to university



# We believe well-designed washrooms should be available to everyone...



Bushboard have been developing cubicle and washroom systems for over 80 years and our reputation has been built on delivering high quality products at affordable prices.

Our tried and trusted range of washrooms for education have been specified time and time again, delivering exceptional washrooms to schools, colleges and universities across the UK.



# Exceptional value, from nursery to university...



Our design team continually strive to ensure our washrooms deliver the perfect balance of quality and value and our education ranges are no exception - whatever the age and whatever the budget.

That's because they have been specifically developed to combine the very best in design with tried and trusted materials and a high degree of flexibility.

It's simple. We work hard to develop great products at great prices so your washroom will work really hard for you!



Angle Door in Colour Creations print, Arrowhead Pilasters in Chili



### Specification Options

- Material: MFC, HPL or SGL (see page 18)
- Colour: 36 Colours, 4 Digital Prints
- Pilasters: Crescent, Arrowhead or Square.
- Fittings: Silver or Charcoal Grey
- Privacy: Standard
- Heights: Doors - 950mm or 1150mm
- Floor Clearance: 105mm

Designed specifically for nursery and infant school children in two height options, Tiny Stuff is a safe, fun and reliable cubicle secured with sturdy floor and wall channels for stability.

Floor-mounted pilasters and sturdy wall fixings ensure robustness and the shaped doors and pilasters are so much fun!

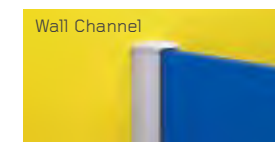
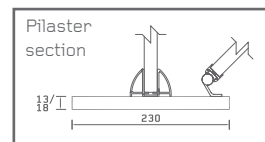
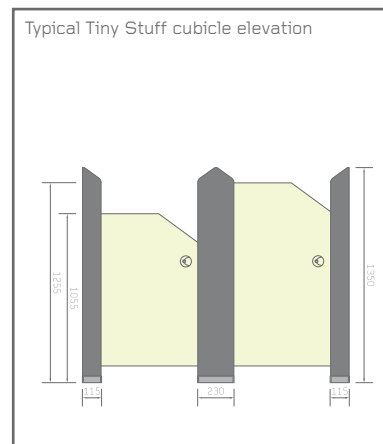

Note: Tiny Stuff cubicles must be installed onto a concrete sub floor. Where this is not possible please contact us to discuss options.

©Bushboard Washroom Systems Ltd, 2014



Curvy Door in Jumble Blocks print, Crescent Pilasters in Zest



### Specification Options

- Material: MFC, HPL or SGL (see page 18)
- Colour: 36 Colours, 4 Digital Prints
- Pilasters: Crescent, Arrowhead or Square
- Fittings: Silver or Charcoal Grey
- Privacy: Standard
- Heights: Doors - 1350mm or 1550mm
- Floor Clearance: 105mm

Developed in two height options for infant and junior school children, Kids Stuff is a dependable cubicle that is safe and fun.

Headrails can be individual or continuous and are through fixed for added strength. Features anti finger trap safety hinges along with partitions that are fixed to walls with specially designed tamper proof channels. Finished at floor level with sturdy floor fixed pilasters.

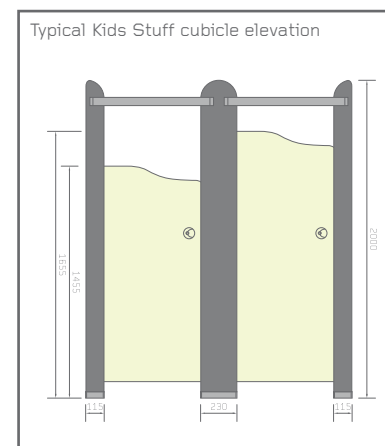
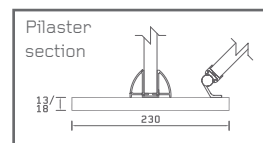

Doors in Oasis, Pilasters in Welsh Slate



### Specification Options

- Material: MFC, HPL or SGL (see page 18)
- Colour: 36 Colours, 4 Digital Prints
- Pilasters: To match performance spec
- Fittings: Silver or Charcoal Grey
- Privacy: Standard
- Heights: 2000mm
- Floor Clearance: 105mm

Tough Stuff is exactly that; a robust and durable cubicle range developed for demanding environments. Ideal for junior, secondary or staff areas as toilet, shower or changing cubicles.

Features sturdy floor and wall fixing channels for stability, powder-coated aluminium hardware and polycarbonate locking mechanism for durability and a through fixed headrail for strength.

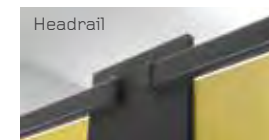
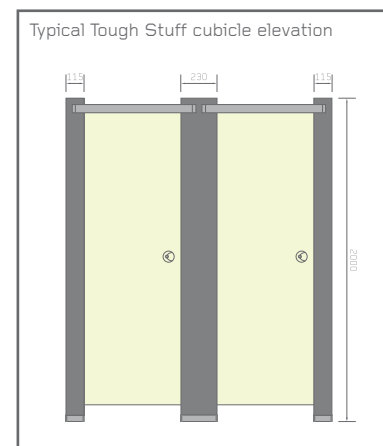
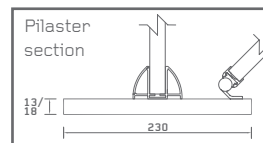

# Profiles Kids™

also available in adult height

Scalloped Doors in Candy, Pilasters in Zest

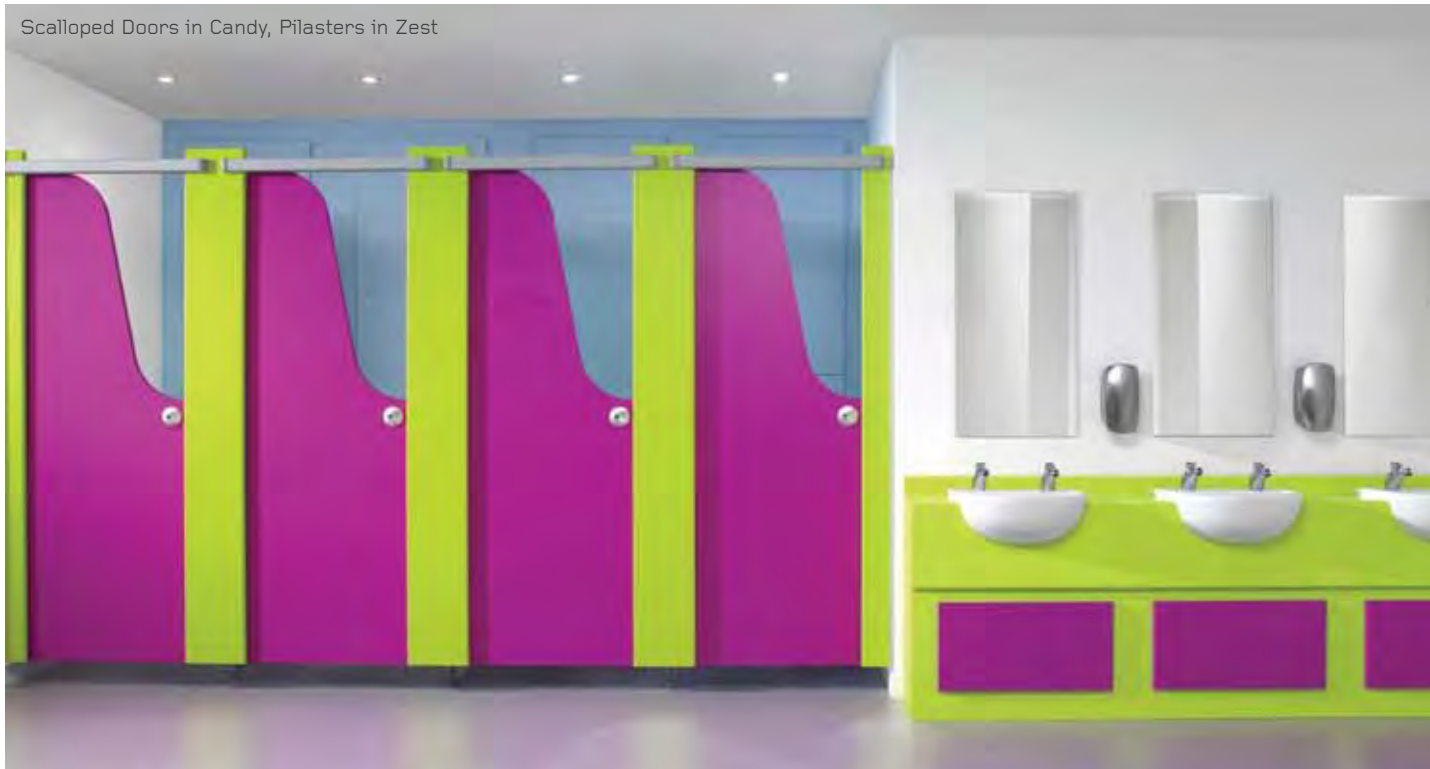

## Specification Options

- Material: MFC, HPL or SGL (see page 18)
- Colour: 36 Colours, 4 Digital Prints
- Pilasters: Crescent, Arrowhead or Square
- Fittings: Silver or Charcoal Grey
- Privacy: Standard
- Heights: Doors - 995mm, 1245mm, 1445mm or 2000mm
- Floor Clearance: 105mm

Profiles is our most versatile cubicle; flexible enough to suit all ages, economical enough to suit all budgets.

Profiles can be specified for younger children with lower height doors or for secondary schools, colleges, universities and staff areas with full height doors.

Profiles features sturdy aluminium legs and a through fixed headrail for extra strength.

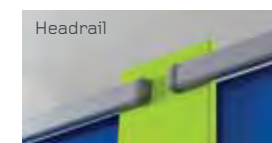
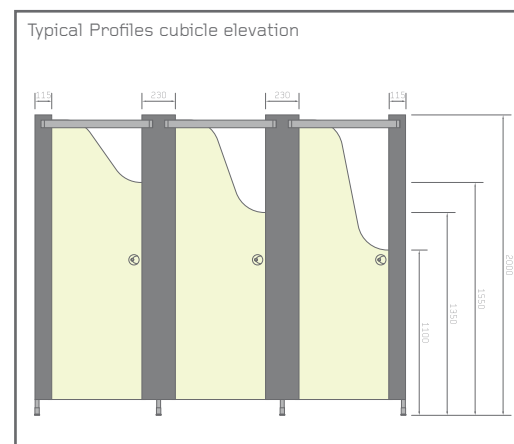
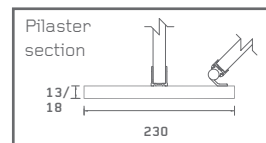

Door and Overpanel in Pacific, Pilasters in Spa



### Specification Options

- Material: MFC, HPL or SGL (see page 18)
- Colour: 36 Colours
- Pilasters: To match performance spec
- Fittings: Silver or Charcoal Grey
- Privacy: Total privacy
- Heights: Variable
- Floor Clearance: 50mm

Developed in response to the growing requirement for added privacy in the washroom, HiZone is a full height cubicle system finished at floor level with aluminium skirting channels and low floor clearance to doors.

HiZone is ideal for secondary schools, colleges and universities and is available with full height door or door and overpanel. The stainless steel washtrough\*, fabricated from a continuous surface and featuring individual tap waste outlets, offers easy ongoing maintenance and is ideal for high traffic, high demand areas.

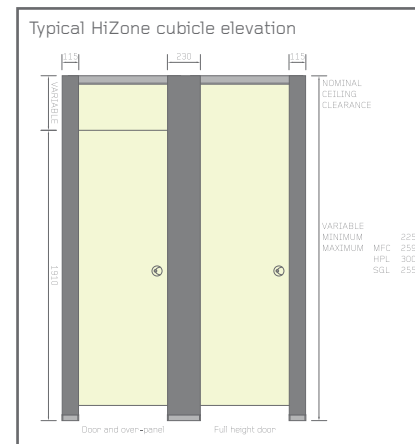
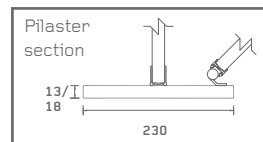

Notes: for ease of delivery and installation partitions are supplied in two horizontal sections. Washtrough must be supplied pre-plumbed or fitted with a service duct.

Doors in Arctic, Pilasters in Bay Leaf



### Specification Options

- Material: MFC, HPL or SGL (see page 18)
- Colour: 36 Colours
- Pilasters: To match performance spec
- Fittings: Charcoal Grey
- Privacy: Standard
- Heights: 1950mm
- Floor Clearance: 150mm

Tight budgets don't mean you have to compromise on quality. If cost is a real constraint then our Baseline ranges are for you!

Baseline works well for staff and older pupils delivering Bushboard's trademark quality and design at very affordable prices. We haven't compromised on the quality of the fittings either with extruded aluminium headrail and pedestal leg.

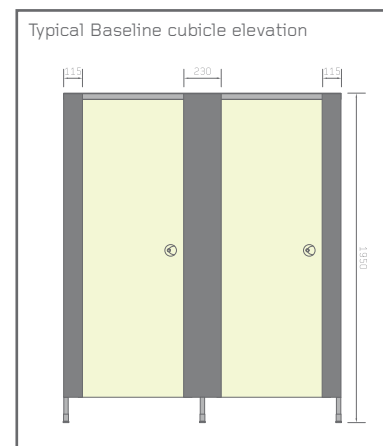
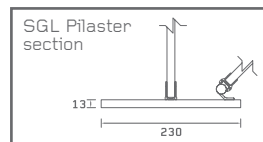
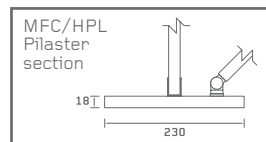

# Lockers and Benching

Tel: 01536 533620

Doors and Carcass in Zest



## Specification Options

- Material: Solid surface with aluminium carcass
- Service: Modular
- Colours: 36 colours
- Fittings: Aluminium

## Locking mechanisms

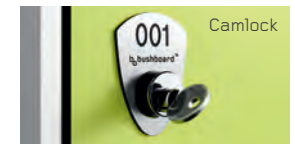
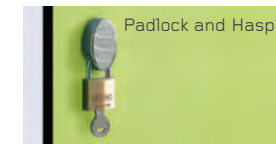

A versatile locker system featuring robust satin anodised carcass for durability, injection moulded interior tray for ease of cleaning and anti-finger trap safety hinges to doors as standard. Doors and carcass are manufactured from solid grade laminate for water resistance and exceptional durability.

Bushboard also supply 6 different bench styles. Ash wood slats complemented by a dark grey nylon coated galvanised steel framework.

View the full range at [www.bushboard-washrooms.co.uk](http://www.bushboard-washrooms.co.uk)

## Benching

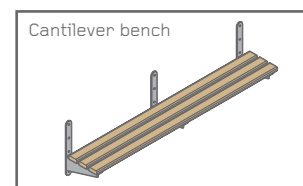
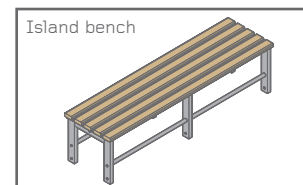

Other bench types available.

## Lockers

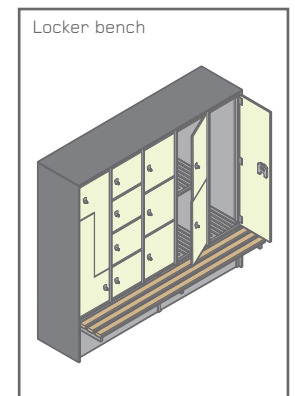
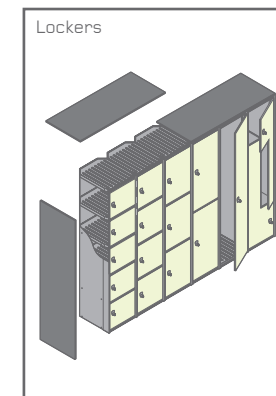

\* Padlock and key to be supplied by others

# Vanity Units – SGL, HPL and Solid Surface

Semi-Recessed HPL Vanity Unit, Vanity Top and Carcass in Zest, underpanels in Candy



Countertop SGL Vanity Unit, Vanity Top and Panels in Pampas, Carcass in Arctic



Solid Surface Vanity Unit, Vanity Top in Elysian, Carcass and Panels in Aubergine

## Specification Options

- Performance:
  - Top – HPL, SGL, Solid Surface
  - Underpanel – MFC, HPL, SGL
- Service: Modular or Bespoke
- Colour: 36 Colours, 10 Solid Surfaces
- Upstand: With or without
- Vanity Ends: With or without
- Heights: 600mm, 675mm, 750mm, 800mm

Our vanity units are smart, hardwearing and practical. Choose from countertop or semi-recessed styles in 4 height options. Semi-recessed vanities are a great option for nursery and infant children, as they allow easy access to taps. They are also perfect for areas where space is tight.

For older children countertop vanities offer more surface space.

We can deliver your vanity pre-plumbed with sanitaryware and brassware or as a panel only option allowing you to choose your own - see page 15.

For ultra hardwearing vanity units, choose a solid surface top.

Manufactured from an advanced composition of minerals and acrylic polymers, it delivers a seamless finish and requires minimal maintenance.

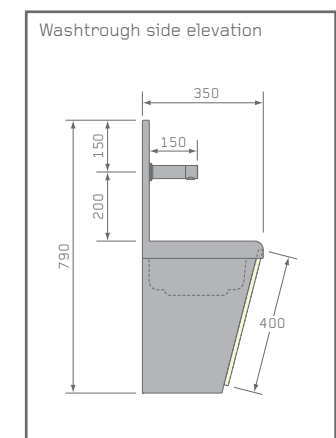
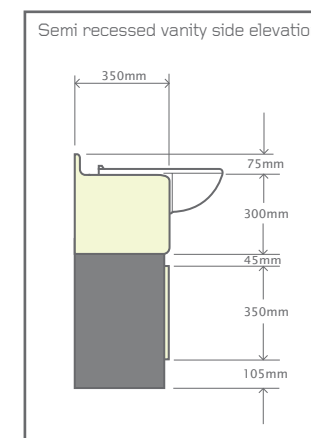
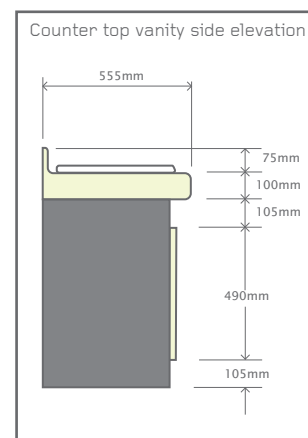

Ducting adds a co-ordinated finishing touch to any washroom and we can deliver it in three ways:

- As a **Ready Plumbed Module** (RPM) – where we supply rigid aluminium frame, access panels and pre-plumbed sanitaryware for fast, hassle free installation (see page 13)
- As **Ezeeduct** - where we supply rigid aluminium frame and access panels. You purchase your own sanitaryware for added flexibility.
- As **Panel Only** – where we supply the panels and you purchase your own sanitaryware and build your own timber frame.



# The benefits of choosing Bushboard Ready Plumbed Modules

**Changing the way washrooms are installed, pre-plumbed systems make duct fitting faster and easier. Delivered ready to install, each module combines a carefully selected range of sanitaryware and brassware fitted to panels and pre-assembled onto a rigid aluminium frame so on-site labour is kept to a minimum and the finished look is always first class.**

First designed nearly 10 years ago we wanted our RPM system to be the best pre-plumbed system on the market and today over 50,000 units are in use across the UK.

## → Guaranteed quality:

a factory engineered solution that uses standardised processes and the latest manufacturing technology to deliver an exceptionally high quality, durable finished product

## → Improved cost control:

one product delivered from one source ensuring greater predictability of cost and programming

## → Utilisation of off-site

**skills:** removes the interface between joinery and plumbing trades reducing reliance on skilled labour on-site

## → Improved sustainability:

reduces the impact of construction activities on-site including noise, vehicle movements and waste reduction

## → Reduced accidents:

transferring work off site into our controlled production environment reduces site health and safety issues

## → Reduced costs:

our independent research proves RPM is up to 20% cheaper than traditional timber frame and panelling\*

## → Time savings on-site:

delivered ready to fit, RPM is proven to be up to 75% faster to install than traditional timber frame and panelling\*

## → Testing off-site:

units are pressure tested prior to delivery to ensure they are ready to install

## → Delivery and distribution:

units delivered palletised for ease of handling and distribution on-site

## Hinged and lockable access panels

The RPM extruded aluminium frame has been specifically designed to incorporate hinged panels to meet the increasing demand for quick and easy access to essential services for routine maintenance.

In addition, hinges make for easier manual handling and because panels are not completely removed to access pipework, any risk of damage or water ingress from potentially wet floors is eliminated.

The option of locks is ideal for areas where security is paramount.

Please note: Hinged panels available at a minimum height of 400mm and a maximum width of 700mm. Panels above 1500mm high must have 2 locks.



- 1 Hinged and lockable access panels
- 2 MFC and HPL hinge in pressed steel
- 3 SGL hinge in industrial nylon and extruded aluminium
- 4 Optional locks

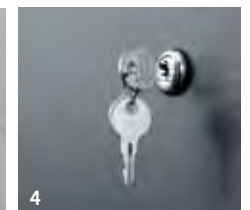
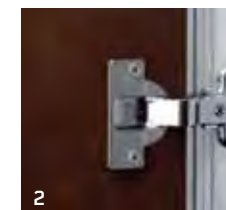

\* Research carried out by QMP, an independent partnership of surveyors, architects and designers.

# Ready Plumbed Module Sanitaryware and Brassware

Our carefully selected range of sanitaryware and brassware has been chosen to deliver style, durability, consideration to the environment and above all excellent value for money.

Working in partnership with a number of leading suppliers, we have the flexibility to produce a range of pre-plumbed solutions suitable for any project or budget.



**Going Green!** Whether you want to ensure the products you choose can help save water or are trying to achieve a BREEAM rating, we have products that can help.

Opposite is a selection of our products. To view the full range visit [www.bushboard-washrooms.co.uk](http://www.bushboard-washrooms.co.uk)

In partnership with:



SanCeram

Twyford

Deva<sup>™</sup> inta



## WCs and Flushing

### Staple School WC Pan

Designed specifically for schools. No hidden channels, no dirt traps, easy to clean, optional blue seat and available in 2 heights.



### Chartham Back to Wall WC

Our most economical WC but still smart, stylish and easy to clean.



### Vandal Resistant WC Pan

Vandal Resistant WC pan, ideal for high-volume, high-use and extremely demanding washroom areas.



### Wave On Wave Off WC Flush

Part of our "Going Green" range of Water Saving products.



### Pneumatic Dual Flush Valve

A "Going Green" product that offers the choice of a 6L or 4.5L flush.



## Hand Washing



### Chartham Semi Recessed Basin

Selected for its compact size. Not only does it save space, it's perfect for small hands and easy to reach for little ones.



### Press Action Taps

Easy to use and a cost-effective option that helps reduce water usage.



### No Touch Classic Tap

An automatic tap that allows you to set the optimum water temperature and helps reduce water consumption.



## Urinals

### Chartham Concealed Trap Urinal

Concealed inlet and back outlet make it ideal for environments prone to vandalism.

## Accessories

Don't forget about accessories! Complete your washroom with our range that covers everything from toilet roll holders to paper towel and soap dispensers.



For our full range visit: [www.bushboard-washrooms.co.uk](http://www.bushboard-washrooms.co.uk)

# Get creative!

Tel: 01536 533620



With 36 stunning colour options, exciting laminate prints, shaped pilasters and doors, and two fittings colours, designing washrooms has never been so much fun!

Children want welcoming washrooms that are bright, clean and safe. Colour plays a vital role in achieving great washroom design and kids just love experimenting with our colour range and unique laminate prints for doors.

## Cubicle fittings colours

All children's cubicle fittings are available in Silver and Charcoal Grey.



Silver



Charcoal Grey



Exciting Digital Prints for Doors

## Wild at Art

"This is my favourite because I like the pattern and the colours are fun."

Tommy, aged 8

## Colour creations

"The circles are nice and bright and good for art as it shows how to make other colours."

Tara, aged 7

## Hand prints

"I like the bright hand colours."

Maggie, aged 4

## Jumble blocks

"I love this because it is so colourful, all mixed up and fun to look at!"

Joseph, aged 7



Note: Laminate prints incur a surcharge and are only available on HPL. Images are not to scale.

# Now experiment with colour!

## Visit our design studio

Now experiment with our colour range by visiting our on-line Washroom Designer Tool, created to make choosing your colour scheme as easy as 1,2,3!



➔ **1** Start with our photo real blank canvas and select an item to colour.

---



From here to here!

➔ **2** Add a splash of your chosen colour at the touch of a button until your washroom is completed.

---

➔ **3** Once you are happy with your chosen colour scheme simply print your design.

---



## Presentation boards for presentations to the board!

Schools love our tailored mood boards. We can help with suggesting colour schemes or tell us your ideas and we will deliver your individual sample board in just 48 hours.



## Next Day Laminate sample service

Our 15cm x 15cm laminate samples are a must when deciding on your colour scheme.

Delivered in just 24 hours you can order via our website or call 01536 533620.



## Material Options

### Melamine Faced Chipboard (MFC)

Light to medium use – dry environments – Nominal panel thickness 18mm

MFC is the most economical material we offer and great for projects where budget is key. The moisture resistant chipboard core is faced both sides with durable Melamine. Panel edges are square and lipped with 1mm matching PVC.

---

### High Pressure Laminate (HPL)

Medium to heavy use – dry environments – Nominal panel thickness 18mm

Offering an excellent balance between cost and durability our high performance High Pressure Laminate panels are heat, scratch and impact resistant. The chipboard core is moisture resistant and edges can be square or postformed.

---

### Solid Grade Laminate (SGL)

Heavy use – wet or dry environments – Nominal panel thickness 13mm

SGL is a really tough material that is perfect for hard working, demanding washrooms. The high density solid grade material is totally impervious to water and offers excellent impact resistance. Panel edges are polished black as standard.

## Vanity Units

As well as High Pressure Laminate and Solid Grade Laminate, vanity tops are also available in Solid Surface.

---

### Solid Surface

Heavy use - Wet or dry

Solid surface is manufactured from an advanced composition of minerals and acrylic polymer that delivers a seamless finish to vanity tops and is exceptionally hardwearing.

\* All lipping is applied with PUR adhesive

\*\* MFC and HPL not suitable for use in wet environments

All our panels are manufactured to your specific site dimensions and full CAD drawings are supplied with delivery.

You also have the option to receive drawings for your approval prior to manufacture. Ask us for details.

➤ Cubicle and Panel only - 3 weeks (MFC,HPL,SGL)

➤ RPM and Ezeeduct - 3 weeks (MFC,HPL,SGL)\*

➤ If you require drawings for approval, please add one week to lead times

## Need your Washroom Installing?



With our UK wide network of preferred installers we can help put you in touch with fitters in your area who are completely familiar with our washroom ranges and offer a great service. Call us for details.

## Special Requirements

Because we manufacture to your specific requirements we can be flexible and work with your space and needs. Our ranges can be delivered to comply with Building Regulations Part M and the Equality Act 2010\*\*.

## Need a Helping Hand?



We know that planning a new washroom can be a daunting task. With our Helping Hands service, our experienced and friendly team of advisors can guide you through the process from planning your layout to choosing the right product, as well as helping you to meet your budget, choosing colours and complying with the latest building regulations. We are happy to visit you on site and offer a free site survey and quotation service.



All of our products come with a 5 year guarantee

## Don't forget our main washroom catalogue where you will find more Bushboard washroom products to choose from!

\* For RPM (pre-plumbed) contact us for lead times.

\*\* It is the responsibility of the customer to work towards your obligation to the Equality Act 2010 and to comply with the latest Building Regulations Part M.

We recommend you contact your Local Authority Access Control Officer.

Bushboard Washroom Systems Ltd  
Unit 1400 1st Floor Montagu Court  
Kettering Parkway  
Kettering Venture Park  
Kettering  
Northants  
NN15 6XR  
T 01536 533620  
F 01536 533648

[washrooms@bushboard-washrooms.co.uk](mailto:washrooms@bushboard-washrooms.co.uk)  
[www.bushboard-washrooms.co.uk](http://www.bushboard-washrooms.co.uk)

After Sales and Customer Care  
T: 01536 533667

Colours in this brochure are as accurate as the printing process allows.  
Bushboard Washroom Systems Ltd reserves the right to alter or change  
specification without notice.

