

Uniclass L2226
CI/SfB
(22.3)   X
October 2012



WASHROOMS THAT WORK

# Washroom Brochure



# We believe well designed washrooms should be available to everyone.



Bushboard have been developing cubicle and washroom systems for over 80 years and our reputation has been built on delivering quality products at affordable prices.

We do this by combining innovative design with quality materials and fittings to deliver great style and great value.

This straightforward approach means our tried and trusted ranges are specified time and time again.



Sentinel Cubicles with Chartham Back to Wall Pan

# Exceptional products at exceptional prices.



Through our experience, we have perfected the art of delivering cost-effective washrooms without compromising on quality.

Attention to detail, in-built functionality, and the latest technology mean that we can deliver excellent value for money, every time.

It's simple. We work hard to develop great products at great prices so your washroom will work really hard for you.



Paraline Platinum Cubicles with Marden Wall Hung Pan

## We have shown Definition Full Height Cubicles

**Headrail:** Aluminium in Brushed Stainless Steel Effect

**Panels:** Arctic

**Pilasters:** Arctic

**Hardware:** Stainless Steel Faceplate

**Foot:** 20mm Stainless Steel Pedestal Foot

**Vanity:** Solid Surface Vanity in Elysian with Integral Basin and Insignia Lever Tap; Underpanels and Frame in Arctic



# Service and support.

From initial planning through to installation, we work hard to make sure choosing the right washroom at the right price is as easy as possible.

- **Specification** – From site visits to writing National Building Specifications (NBS), our UK wide team of Specification Managers are always on hand to help.
- **Estimating** – Our quotations are designed to give you a clear and concise breakdown of products and costs.
- **CAD** – You will be assigned a dedicated CAD technician who can draft drawings for approval prior to manufacture.
- **Delivery** – All delivery costs are included within our price.\*
- **Installation** – Our UK wide network of preferred installers are completely familiar with our washroom ranges and offer an exceptional service.
- **After Sales** – Your dedicated contact in our friendly and efficient after sales team will guide you from order to delivery and beyond.
- **Guarantees** – All of our products come with a 5 year guarantee.

\* Mainland UK only.



Aero Pearl Cubicles with Marden Wall Hung Pan

# Choosing your washroom couldn't be simpler.

Whether you are driven by budget or design, our simple 3 step process will ensure that your washroom is perfectly suited to your individual requirements.



# 1

Choose your cubicle system  
**see pages 7-43**

Our range of 14 cubicles are designed to deliver the perfect balance of quality and value by combining the very best in design with tried and trusted materials.

See pages 27-41 for our range of cubicles for children.

# 2

Choose your ducting system  
**see pages 44-57**

We offer pre-plumbed systems for fast and cost-effective installation, or for increased flexibility you can supply and fit your own sanitaryware with our Ezeeduct or panel only options.

# 3

Choose your vanity system  
**see pages 58-63**

We offer a number of smart, practical and hardwearing vanities to suit your needs. Choose pre-plumbed or supply and fit your own sanitaryware with our Ezeevanity and panel only options.

For Fastrack washrooms, Lockers, Benching & Accessories see pages 64-75.

# Choose your cubicle system



Bushboard cubicles are designed to deliver quality, durability and excellent value for money, down to the smallest detail.

Not only are our ranges exceptionally designed, they are also exceptionally easy to install and the final finish is always first class.



## We have shown Definition Full Height Cubicles

**Headrail:** Aluminium in Brushed Stainless Steel Effect

**Panels:** Wenge

**Pilasters:** Wenge

**Hardware:** Stainless Steel Faceplate

**Foot:** 20mm Stainless Steel Pedestal Foot

**Vanity:** Solid Surface Vanity in Elysian with Integral Basin and Insignia Lever Tap, Underpanels and Frame in Arctic



# Definition™

Definition is simplicity itself. Uncomplicated design, stunning hardware, at an exceptional price. This flush fronted cubicle range is nothing short of flawless.

Specify with our SanCeram sanitaryware range (see page 48) for our most cost-effective flush-fronted washroom system ever.

## Specification Options

### → Performance

MFC  
HPL  
SGL

### → Pilasters

To match performance specification

### → Headrail

Aluminium in Brushed Stainless Steel Effect

### → Fittings

Stainless Steel Grade 316

### → Heights

Full height  
Standard: overall height 2020mm

### → Floor Clearance

20mm  
100mm

### → Ceiling Clearance

Full height: Minimum 20mm  
Standard height: Variable

### → Colours

36 Laminate Options

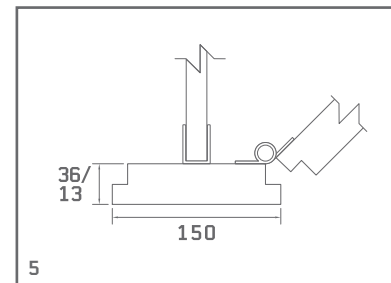

- 1 Faceplate
- 2 Lock
- 3 Headrail
- 4 Pedestal Foot
- 5 Pilaster section

\* Note: Only MFC and HPL panels are fixed with channels. SGL panels are fixed with brackets.

## We have shown Paraline Full Height Cubicles

**Pilasters and Headrail:** Aluminium in Platinum Finish

**Panels:** Crown Cut American Black Walnut Veneer edged in 3mm matching tipping

**Hardware:** Stainless Steel Faceplate

**Foot:** 20mm Stainless Steel Pedestal Foot

**Vanity:** Solid Surface Cantilever Vanity in Drift with Harvel Vessel Basin and Swoop Luxury Vessel Lever Tap



# Paraline™

Simple, sleek and modern. Paraline's beautifully crafted streamlined pilasters and headrail bring you a truly contemporary washroom system that is solid, strong and ultra stylish.

## Paraline Platinum

Choose our Platinum finish and see Paraline's impressive styling brought to life. The crisp, clean extruded aluminium pilasters and headrail in elegant Brushed Stainless Steel effect bring you the optimum in washroom cubicles.

### Specification Options

#### → Performance

Real Wood Veneer  
MFC  
HPL  
SGL

#### → Pilasters and Headrail

Aluminium in Platinum Finish

#### → Fittings

Stainless Steel Grade 316

#### → Heights

Floor to ceiling\*  
Full height  
Standard: overall height 2000mm

#### → Floor Clearance

20mm

#### → Ceiling Clearance

Floor to ceiling: 20mm\*  
Full height: Minimum 20mm  
Standard height: Variable

#### → Colours

36 Laminate Options  
Wood Veneer Selection

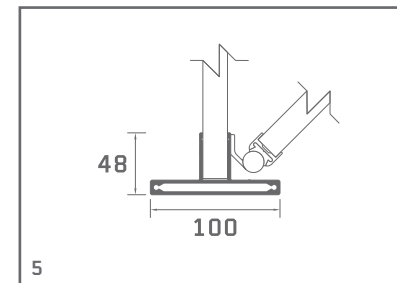

- 1 Faceplate
- 2 Lock
- 3 Pilaster
- 4 Pedestal Foot
- 5 Pilaster section

\* Note: For floor to ceiling Paraline, specify without headrail. On the floor to ceiling height option, pilasters are fixed directly to the ceiling; the 20mm ceiling clearance applies to doors only.



## We have shown Aero Floor to Ceiling Cubicles

**Pilasters and Headrail:** Aluminium in Pearl Finish

**Panels:** Macassar Ebony Veneer\* edged in 3mm matching tipping

**Hardware:** Stainless Steel Faceplate

**Foot:** Stainless Steel Pilaster Foot

**Vanity:** Solid Surface Washtrough in Elysian with Swoop Luxury Lever Tap



Aero's iconic curved aluminium floor mounted pilasters and matching headrail blend style and strength to deliver a beautifully smart and distinguished cubicle system.

## Aero Pearl

Our striking Pearl finish, exclusive to Aero, has a lustrous quality that will add a touch of luxury to the most prestigious of washrooms. Unique to Bushboard, Pearl is stunning to look at and superbly durable.

### Specification Options

#### → Performance

Real Wood Veneer  
MFC  
HPL  
SGL

#### → Pilasters and Headrail

Pearl

#### → Fittings

Stainless Steel Grade 316

#### → Heights

Floor to ceiling\*  
Full height  
Standard: overall height 2000mm

#### → Floor Clearance

20mm

#### → Ceiling Clearance

Floor to ceiling: 20mm\*  
Full height: Minimum 20mm  
Standard height: Variable

#### → Colours

36 Laminate Options  
Wood Veneer Selection

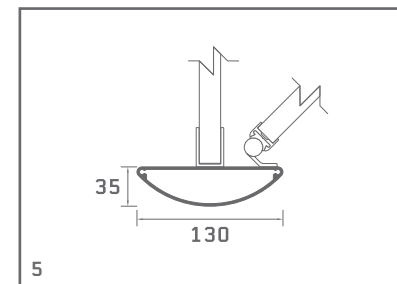

- 1 Faceplate
- 2 Lock
- 3 Pilaster Top Fixing
- 4 Pilaster Foot
- 5 Pilaster section

\* Note: For floor to ceiling Aero, specify without headrail. On the floor to ceiling height option, pilasters are fixed directly to the ceiling; the 20mm ceiling clearance applies to doors only.

# Washrooms have never looked so good with our stylish Powder Coat finishes; Alpine, Titanium and Mineral.

All three colourways are available exclusively on both our Paralane and Aero ranges and are highly durable, easy to keep clean and elegant.

Add Stainless Steel hardware to create a striking look or for design simplicity itself opt for complementary Powder Coated hardware.

Finish your cubicle design by visiting us at [www.bushboard-washrooms.co.uk](http://www.bushboard-washrooms.co.uk) to view our exciting palette of panel colours.



---

## Choose your washroom in three simple steps:

→ Choose your range:



Paralane



Aero

→ Choose your finish:



Alpine



Titanium



Mineral

→ Choose your hardware:



Stainless Steel\*

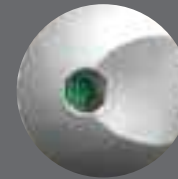

ABS Titanium

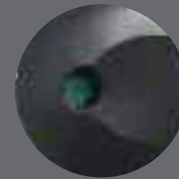

ABS Mineral

\* Stainless steel incurs a surcharge. Please contact us for more details.

Create a visually stunning washroom by combining fresh Alpine Powder Coat with elegant Stainless Steel hardware then select from our exciting range of laminate colours or rich wood veneer.

For the height of sophistication choose full height cubicles and low 20mm floor clearance\*.

### Specification Options

→ **Performance**

Real Wood Veneer  
MFC  
HPL  
SGL

→ **Pilasters and Headrail**

Alpine  
Titanium  
Mineral

→ **Fittings**

Titanium  
Mineral  
Stainless Steel Grade 316

→ **Heights**

Floor to ceiling\*\*  
Full height  
Standard: overall height  
2000mm

→ **Floor Clearance**

Stainless steel: 20mm or  
100mm  
Powder coated: 105mm

→ **Ceiling Clearance**

Floor to ceiling: 20mm\*\*  
Full height: Minimum 20mm  
Standard height: Variable

→ **Colours**

36 Laminate Options  
Wood Veneer Selection



### We have shown Paralane Standard Height

**Pilasters and Headrail:** Aluminium in Alpine Powder Coat

**Panels:** Zest

**Hardware:** Stainless Steel

**Foot:** 100mm Stainless Steel Pedestal Foot



1 Headrail with end cap



2 Faceplate



3 Pedestal Foot



4 Pilaster

\* Please note: 20mm floor clearance is only available with stainless steel fittings.

\*\* Note: On the floor to ceiling height option, pilasters are fixed directly to the ceiling; the 20mm ceiling clearance applies to doors only.

Specify our Titanium finish and create a washroom that is beautifully simple. Opt for Stainless Steel fittings and elevate your finished washroom look even further.

Shown here is Paralane in Titanium finish, alternatively Titanium looks equally impressive in our Aero range.

### Specification Options

→ **Performance**

Real Wood Veneer  
MFC  
HPL  
SGL

→ **Pilasters and Headrail**

Alpine  
Titanium  
Mineral

→ **Fittings**

Titanium  
Mineral  
Stainless Steel Grade 316

→ **Heights**

Floor to ceiling\*  
Full height  
Standard: overall height  
2000mm

→ **Floor Clearance**

Stainless steel: 20mm or  
100mm  
Powder coated: 105mm

→ **Ceiling Clearance**

Floor to ceiling: 20mm\*  
Full height: Minimum 20mm  
Standard height: Variable

→ **Colours**

36 Laminate Options  
Wood Veneer Selection



### We have shown Paralane Standard Height

**Pilasters and Headrail:** Aluminium in Titanium Powder Coat

**Panels:** Thatch

**Hardware:** ABS Faceplate in Titanium

**Foot:** 105mm Aluminium Pedestal Foot in Titanium Powder Coat with matching Plastic Moulded Shroud



1 Headrail with end cap



2 Faceplate



3 Pedestal Foot



4 Pilaster

\* Note: On the floor to ceiling height option, pilasters are fixed directly to the ceiling; the 20mm ceiling clearance applies to doors only.

For effortless sophistication choose our sleek and smooth Mineral Powder Coat. Pilasters and headrail are enhanced by the elegant, complementary Powder Coated hardware. For a striking combination choose Stainless Steel fittings.

Specify Paraline in Mineral for an ultra modern feel.

### Specification Options

→ **Performance**

Real Wood Veneer  
MFC  
HPL  
SGL

→ **Pilasters and Headrail**

Alpine  
Titanium  
Mineral

→ **Fittings**

Titanium  
Mineral  
Stainless Steel Grade 316

→ **Heights**

Floor to ceiling\*  
Full height  
Standard: overall height  
2000mm

→ **Floor Clearance**

20mm  
100mm

→ **Ceiling Clearance**

Floor to ceiling: 20mm\*  
Full height: Minimum 20mm  
Standard height: Variable

→ **Colours**

36 Laminate Options  
Wood Veneer Selection



### We have shown Aero Standard Height

**Pilasters and Headrail:** Aluminium in Mineral Powder Coat

**Panels:** Deep Lilac

**Hardware:** ABS Faceplate in Mineral

**Foot:** 100mm Aluminium Pilaster Foot in Mineral Powder Coat



1 Headrail with end cap



2 Faceplate



3 Pilaster Foot



4 Pilaster

\* Note: On the floor to ceiling height option, pilasters are fixed directly to the ceiling; the 20mm ceiling clearance applies to doors only.

## We have shown Sentinel Standard Height Cubicles

**Pilasters and Headrail:** Fluted Aluminium in Silver Powder Coat

**Panels:** Aubergine

**Hardware:** ABS Faceplate in Silver

**Foot:** Down to Floor Fluted Aluminium Pilaster in Silver Powder Coat

**Vanity:** Solid Surface Top in Elysian with Integral Basin and Insignia Tap, Underpanels and Frame in Aubergine



# Sentinel™

Demanding environments call for hard-wearing, long-lasting washrooms; Sentinel's fluted aluminium pilasters and headrail provide exactly that.

Blending style and strength, the iconic metal framing delivers a sleek, streamlined finish, whilst optional aluminium privacy skirting and low floor clearance offer additional privacy.

## Specification Options

### → Performance

MFC  
HPL  
SGL

### → Pilasters

Silver  
Charcoal Grey

### → Fittings

Silver  
Charcoal Grey

### → Heights

Standard: overall height 2000mm

### → Floor Clearance

50mm (with privacy skirting)  
105mm

### → Colours

36 Laminate Options  
4 Digital Prints

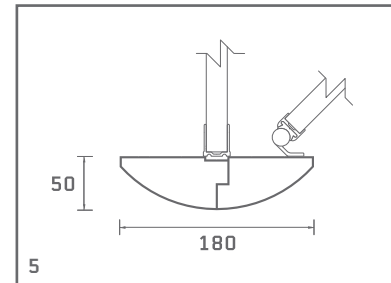

- 1 Faceplate
- 2 Lock
- 3 Pilaster Top Fixing
- 4 Pilaster Foot
- 5 Pilaster section



## We have shown Quadro Standard Height Cubicles

**Headrail:** Continuous Aluminium Headrail in Charcoal Powder Coat

**Panels:** Zest

**Hardware:** ABS Faceplate in Charcoal Grey

**Foot:** Down to Floor Plaster in Welsh Slate, mounted into Charcoal ABS shoe

**Vanity:** Counter Top Vanity with Staple Counter Top Basin and Vision Mixer Tap; Top and Frame in Welsh Slate, Panels in Zest



# Quadro™

Competitively priced and offering functional style, Quadro is a universal solution, ideal for any washroom environment.

The distinctive quadrant foot and headrail deliver strength and style, whilst optional aluminium skirting delivers additional privacy.

## Specification Options

### → Performance

MFC  
HPL  
SGL

### → Pilasters

To match performance specification

### → Fittings (see page 28)

6 external fittings colours

### → Heights

Standard: overall height 2000mm

### → Floor Clearance

50mm (with privacy skirting)  
105mm

### → Colours

36 Laminate Options  
4 Digital Prints

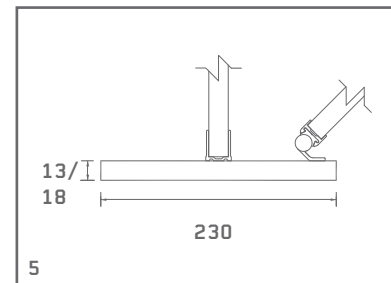

- 1 Faceplate
- 2 Lock
- 3 Pilaster Top Fixing
- 4 Pilaster Foot
- 5 Pilaster section

## We have shown HiZone Cubicles with Full Height Doors

**Headrail:** Individual Aluminium Headrail in Silver Powder Coat

**Panels:** Warm Oak

**Hardware:** ABS Faceplate in Silver

**Foot:** Down to Floor Pilaster in Arctic, mounted into Silver ABS shoe

**Vanity:** Manden Wall Hung Basin and Kludi Mini Lever tap, mounted onto panels in Warm Oak



# HiZone™

We developed HiZone as the perfect solution to the ever-growing demand for privacy in the washroom.

These full height cubicles are finished at ground level with smart powder coated channels and at ceiling level with a simple powder coated headrail.

Available with full height door, or door and overpanel.

## Specification Options

### → Performance

MFC

HPL

SGL

### → Pilasters

To match performance specification

### → Fittings

Silver

Charcoal Grey

### → Heights

Min. 2250mm

Max. MFC 2600mm

HPL 2900mm

SGL 2550mm

### → Floor Clearance

50mm

### → Ceiling Clearance

20mm

### → Colours

36 Laminate Options



1



2



3



4

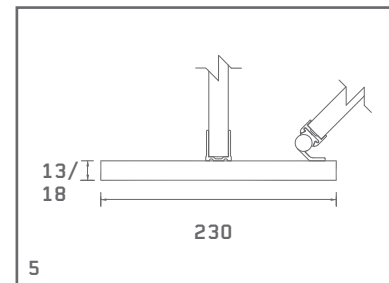

5

- 1 Faceplate
- 2 Lock
- 3 Pilaster Top Fixing
- 4 Pilaster Foot
- 5 Pilaster section

## We have shown Profiles Standard Height Cubicles

**Headrail:** Individual Aluminium Headrail in Silver Powder Coat

**Panels:** Cobalt

**Pilasters:** Zest

**Hardware:** ABS Faceplate in Silver

**Foot:** Aluminium Pedestal Foot in Silver Powder Coat

**Vanity:** Semi-Recessed Vanity with Chartham Semi-Recessed Basin and Self-Closing Taps; Top and Frame in Zest, Panels in Cobalt



# Profiles™

Robust and hardwearing, Profiles is not only our best selling cubicle, but also our most versatile.

Developed to be flexible enough to meet the demands of most environments and economical enough to meet most budgets Profiles is so adaptable.

Specify as we have shown here or choose lower height doors for children's cubicles, specify with curtain rail for shower cubicles or with integral seat for changing cubicles.

## Specification Options

### → Performance

MFC  
HPL  
SGL

### → Pilasters

To match performance specification

### → Fittings (see page 28)

6 external fittings colours

### → Heights

Standard: overall height 2000mm

### → Floor Clearance

105mm

### → Colours

36 Laminate Options  
4 Digital Prints

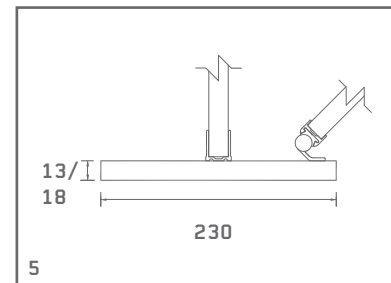

- 1 Faceplate
- 2 Lock
- 3 Pilaster Top Fixing
- 4 Pedestal Foot
- 5 Pilaster section

# Baseline™

Delivering our trademark quality and design at very affordable prices, Baseline comes in a choice of contemporary colours.

This no frills cubicle is finished with a sturdy powder coated aluminium pedestal foot and headrail, ensuring it is robust enough to withstand the busiest of washroom environments.

## Specification Options

### → Performance

MFC  
HPL  
SGL

### → Pilasters

To match performance specification

### → Fittings

Charcoal Grey

### → Heights

1800mm

### → Floor Clearance

150mm

### → Colours

8 Laminate Options



Welsh Slate BB275  
LRV 12.3

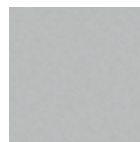

Winter BB274  
LRV 43.4

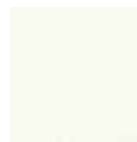

Arctic BB269  
LRV 86.0



Cobalt BB265  
LRV 19.2



Bay Leaf BB255  
LRV 41.0



Banana BB293  
LRV 71.3



Rose BB257  
LRV 42.4



Warm Oak BB272  
LRV 34.5



1



2

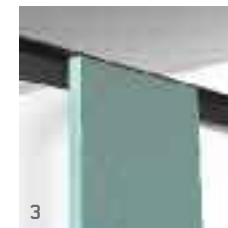

3



4

- 1 Pilasters in Bay Leaf Doors in Arctic
- 2 Faceplate
- 3 Headrail
- 4 Pedestal Foot

# Cubicles for children and education



Our education range takes you from nursery to university and has been designed to provide a choice of safe, hygienic and functional washrooms that are also fun!

Stimulate young minds with stunning colour options, unique laminate print designs and fun shapes. All the building blocks to create the right environment.



# Get creative!



With 36 stunning colour options, exciting laminate prints, shaped pilasters and doors, and 6 fittings colours, designing washrooms has never been so much fun!

Children want welcoming washrooms that are bright, clean and safe. Colour plays a vital role in achieving great washroom design and kids just love experimenting with our colour range and unique laminate prints for doors.

## Cubicle fittings colours

For Tiny Stuff, Kids Stuff and Tough Stuff choose from these 6 external fittings colours. HiZone available with Silver and Charcoal Grey fittings, Baseline available with Charcoal Grey.



Exciting Digital Prints for Doors



## Wild at Art

"This is my favourite because I like the pattern and the colours are fun."

Tommy, aged 8

## Colour creations

"The circles are nice and bright and good for art as it shows how to make other colours."

Tara, aged 7

## Hand prints

"I like the bright hand colours."

Maggie, aged 4

## Jumble blocks

"I love this because it is so colourful, all mixed up and fun to look at!"

Joseph, aged 7



Note: Laminate prints incur a surcharge and are only available on HPL. Images are not to scale.

# Now experiment with colour!

## Visit our design studio

Now experiment with our colour range by visiting our on-line Washroom Designer Tool, created to make choosing your colour scheme as easy as 1,2,3!



➔ **1** Start with our photo real blank canvas and select an item to colour.

---

From here to here!



➔ **2** Add a splash of your chosen colour at the touch of a button until your washroom is completed.

---

➔ **3** Once you are happy with your chosen colour scheme simply print your design.

---

## Presentation boards for presentations to the board!

Schools love our tailored mood boards. We can help with suggesting colour schemes or tell us your ideas and we will deliver your individual sample board in just 48 hours.



## Next Day Laminate sample service

Our 15cm x 15cm laminate samples are a must when deciding on your colour scheme.

Delivered in just 24 hours you can order via our website or call 01536 533620.



## We have shown Tiny Stuff Cubicles

**Panels:** Doors in Colour Creations Print

**Hardware:** Magnetic Door Catch

**Foot:** Down to Floor Arrowhead Pilaster in Chilli, mounted into Silver ABS shoe

**Vanity:** Semi-Recessed Vanity; Top and Frame in Chilli, Panels in Colour Creations Print



# Tiny Stuff®

Designed specifically for nursery and infant school children in two height options, Tiny Stuff is a safe, fun and reliable cubicle secured with sturdy floor and wall channels for stability.

Floor-mounted pilasters and sturdy wall fixings ensure robustness and the shaped doors and pilasters are so much fun!

## Specification Options

### → Performance

MFC  
HPL  
SGL

### → Pilasters

Crescent, Arrowhead or Square  
to match performance specification

### → Fittings (see page 28)

6 external fittings colours

### → Door Heights

950mm  
1150mm

### → Floor Clearance

105mm

### → Colours

36 Laminate Options  
4 Digital Prints

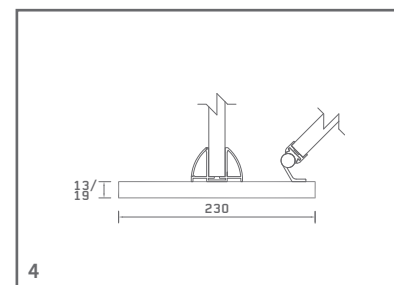

1 Angle Door in Hand Prints, Arrowhead  
Pilasters in Cobalt

2 Wall Channel

3 Pilaster Foot

4 Pilaster section

Note: Tiny Stuff cubicles must be installed onto a concrete sub floor. Where this is not possible please contact us to discuss options.

## We have shown Kids Stuff Cubicles

**Headrail:** Individual Aluminium Headrail in Charcoal Powder Coat

**Panels:** Doors in Jumble Blocks Print

**Foot:** Down to Floor Crescent Pilaster in Zest, mounted into Charcoal ABS shoe

**Vanity:** Semi-Recessed Vanity; Top and Panels in Powder Blue, Frame in Zest



# Kids Stuff™

Developed in two height options for infant and junior school children, Kids Stuff is a dependable cubicle that is safe and fun.

Headrails can be individual or continuous and are through fixed for added strength. Features anti finger trap safety hinges along with partitions that are fixed to walls with specially designed tamper proof channels. Finished at floor level with sturdy floor fixed pilasters.

## Specification Options

### → Performance

MFC  
HPL  
SGL

### → Pilasters

Crescent, Arrowhead or Square  
to match performance specification

### → Fittings (see page 28)

6 external fittings colours

### → Door Heights

1350mm  
1550mm

### → Floor Clearance

105mm

### → Colours

36 Laminate Options  
4 Digital Prints

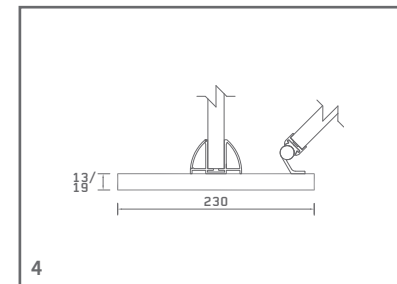

1 Curvy Door in Wild at Art print,  
Crescent Pilasters in Aubergine

2 Headrail

3 Pilaster Foot

4 Pilaster section



## We have shown Profiles Kids Cubicles at 1100mm

- .....**Headrail:** Individual Aluminium Headrail in Silver Powder Coat
- .....**Panels:** Scalloped Doors in Candy
- .....**Pilasters:** Zest
- .....**Foot:** Aluminium Pedestal Foot in Silver Powder Coat
- .....**Vanity:** Semi-Recessed Vanity with Chartham Semi-Recessed Basin and Self-Closing Taps, Top and Frame in Zest, Panels in Candy
- .....



# Profiles Kids™

Profiles is our most versatile cubicle; flexible enough to suit all ages, economical enough to suit all budgets.

Profiles can be specified for younger children with lower height doors or for secondary schools, colleges, universities and staff areas with full height doors.

This flexible system can be adapted for use as a toilet, changing or shower cubicle and features sturdy aluminium feet and a through fixed headrail for strength.

## Specification Options

### → Performance

MFC  
HPL  
SGL

### → Pilasters

Crescent, Arrowhead or Square  
to match performance specification

### → Fittings (see page 28)

6 external fittings colours

### → Door Heights

995mm  
1245mm  
1445mm

### → Floor Clearance

105mm

### → Colours

36 Laminate Options  
4 Digital Prints



1



2



3



4

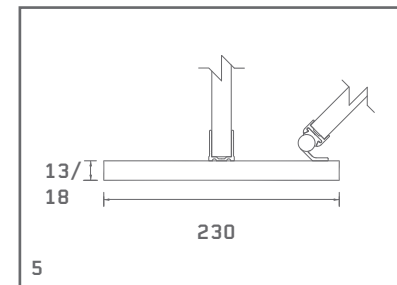

5

- 1 Faceplate .....
- 2 Lock .....
- 3 Pilaster Top Fixing .....
- 4 Pedestal Foot .....
- 5 Pilaster section .....

## We have shown Tough Stuff Standard Height Cubicles

**Headrail:** Individual Aluminium Headrail in Charcoal Powder Coat

**Panels:** Oasis

**Foot:** Down to Floor Plaster in Welsh Slate, mounted into Charcoal ABS shoe

**Vanity:** Counter Top Vanity with Staple Counter Top Basin and Vision Mixer Tap, Top and Frame in Welsh Slate, Panels in Oasis



# Tough Stuff™

Tough Stuff is exactly that; a robust and durable cubicle range developed for demanding environments. Ideal for junior, secondary or staff areas as toilet, shower or changing cubicles.

Features sturdy floor and wall fixing channels for stability, powder coated aluminium hardware, and polycarbonate locking mechanism for durability and a through fixed headrail for strength.

## Specification Options

### → Performance

MFC  
HPL  
SGL

### → Pilasters

Crescent, Arrowhead or Square  
to match performance specification

### → Fittings (see page 28)

6 external fittings colours

### → Heights

Standard: overall height 2000mm

### → Floor Clearance

105mm

### → Colours

36 Laminate Options  
4 Digital Prints

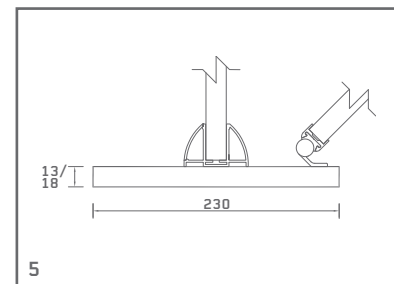

- 1 Faceplate
- 2 Lock
- 3 Pilaster Top Fixing
- 4 Pilaster Foot
- 5 Pilaster section

## We have shown HiZone Cubicles with Door and Overpanels

**Headrail:** Individual Aluminium Headrail in Charcoal Powder Coat

**Panels:** Doors and Overpanel in Pacific

**Foot:** Down to Floor Pilaster in Spa, mounted into Charcoal ABS shoe

**Vanity:** Stainless Steel Washtrough with Aquarius Wall Mounted Sensor Tap: Ducting and Front Panel in Spa

# HiZone™

Developed in response to the growing requirement for added privacy in the washroom, HiZone is a full height cubicle system finished at floor level with aluminium skirting channels and low floor clearance to doors.

HiZone is ideal for secondary schools, colleges and universities and is available with full height door or door and overpanel. The stainless steel washtrough\*, fabricated from a continuous surface and featuring individual tap waste outlets, offers easy ongoing maintenance and is ideal for high traffic, high demand areas.

## Specification Options

### → Performance

MFC  
HPL  
SGL

### → Pilasters

To match performance specification

### → Fittings

Silver  
Charcoal Grey

### → Heights

Min.	MFC	2600mm
Max.	HPL	2900mm
	SGL	2550mm

### → Floor Clearance

50mm

### → Ceiling Clearance

20mm

### → Colours

36 Laminate Options

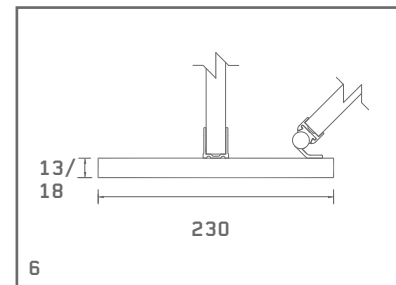
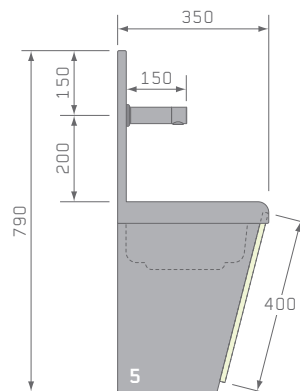

- 1 Faceplate
- 2 Pilaster top fixing
- 3 Foot
- 4 Stainless Steel trough detail
- 5 Washtrough section. Available in 4 sizes:  
 1 person washtrough 0660001 = 800mm  
 2 person washtrough 0660002 = 1400mm  
 3 person washtrough 0660003 = 2000mm  
 4 person washtrough 0660004 = 2600mm
- 6 Pilaster section

Note: For ease of delivery and installation partitions are supplied in two horizontal sections. Laminate prints not available on full height doors.

\* Washtrough must be supplied pre-plumbed or supplied loose for fitting to a service duct.

# Baseline Kids™

Designed specifically for younger pupils, Baseline Kids delivers quality and style at affordable prices.

The range is available in three vibrant colours; so even on a budget, you don't have to compromise on design.

We have made safety a priority too! Low height doors and partitions make for easy supervision and anti finger trap hinges keep little fingers safe, whilst the extruded aluminium headrail and pedestal foot deliver integral strength.

## Specification Options

### → Performance

MFC  
HPL  
SGL

### → Floor Clearance

150mm

### → Colours

3 Laminate Options

### → Pilasters

To match performance specification

### → Fittings

Charcoal Grey

### → Heights

Overall 1950mm  
Doors 1150mm



Chilli BB268  
LRV 18.1



Yellow Ochre BB280  
LRV 58.9



Cobalt BB265  
LRV 19.2



1



2

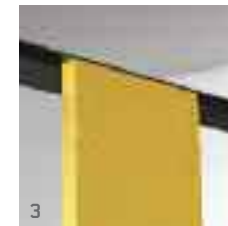

3



4

- 1 Pilasters in Yellow Ochre Doors in Chilli
- 2 Faceplate
- 3 Headrail
- 4 Pedestal Foot

# Summary of education cubicle heights and features

## Cubicles

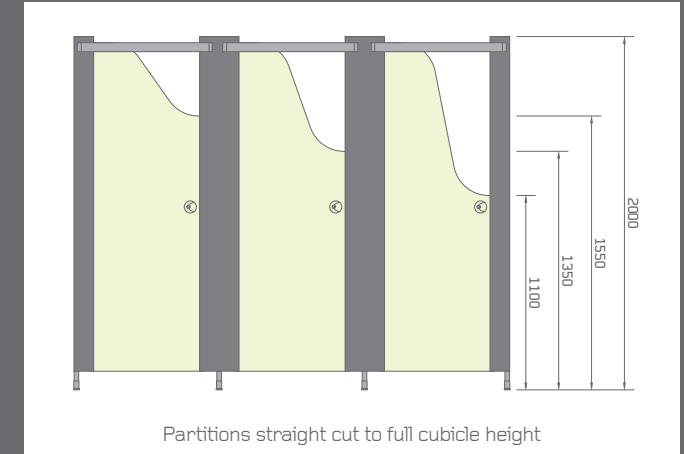
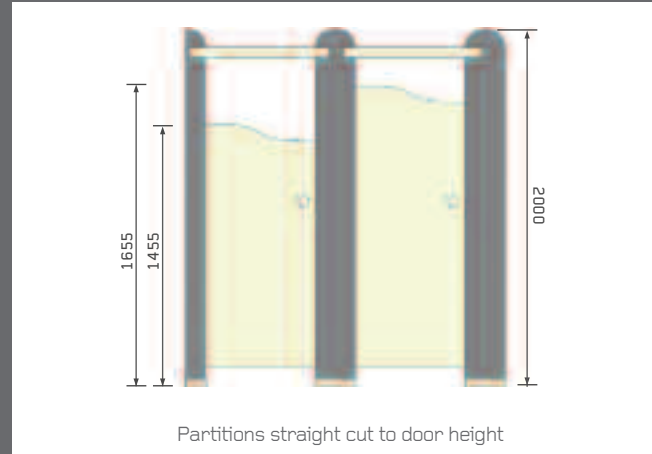
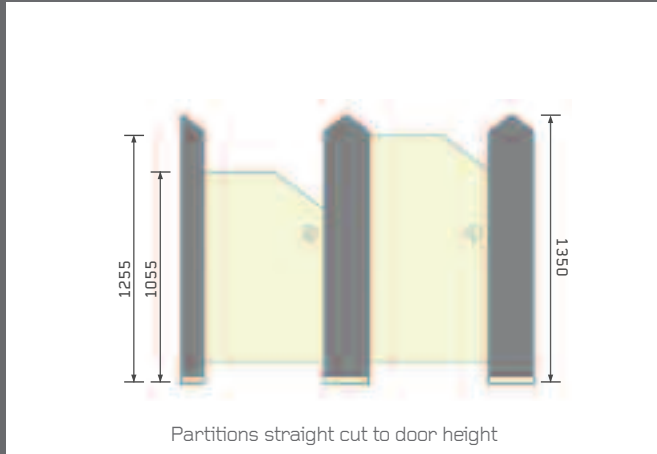

## Tiny Stuff

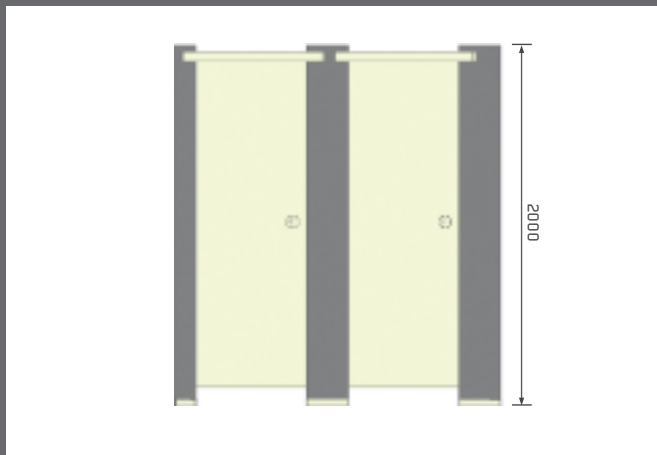

## Kids Stuff

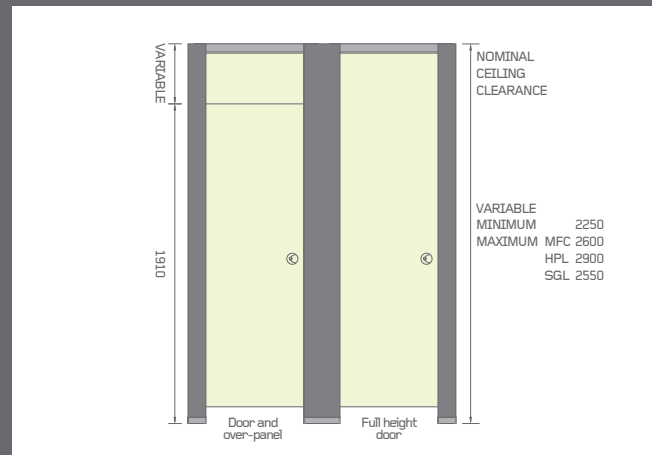

## Profiles Kids

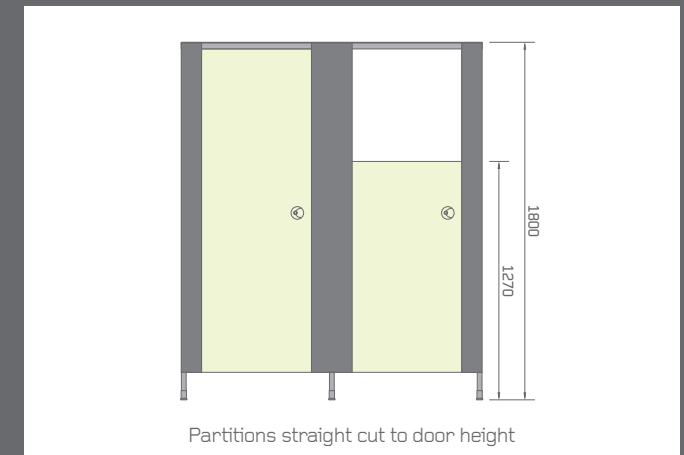

## Tough Stuff

## HiZone

## Baseline Kids

Note: Dimensions shown include floor clearance. Standard floor clearance on all cubicles is 105mm, excluding Hizone (50mm) and the Baseline ranges (150mm). If you choose our Down to Floor privacy option, floor clearance is reduced to 50mm.

# Cubicle elements & configurations

Our team of advisors are happy to offer advice and guidance on your project. On the following pages we have shown the key elements of a typical cubicle and some layout configurations to make it easy for you to discuss your project with us.

You can also download these drawings from our website [www.bushboard-washrooms.co.uk](http://www.bushboard-washrooms.co.uk).

## Typical Cubicle

- 1 Continuous wall channel
- 2 Headrail
- 3 Wall end pilaster
- 4 Inter pilaster
- 5 Continuous hinge channel
- 6 Door
- 7 Partition
- 8 Privacy skirting

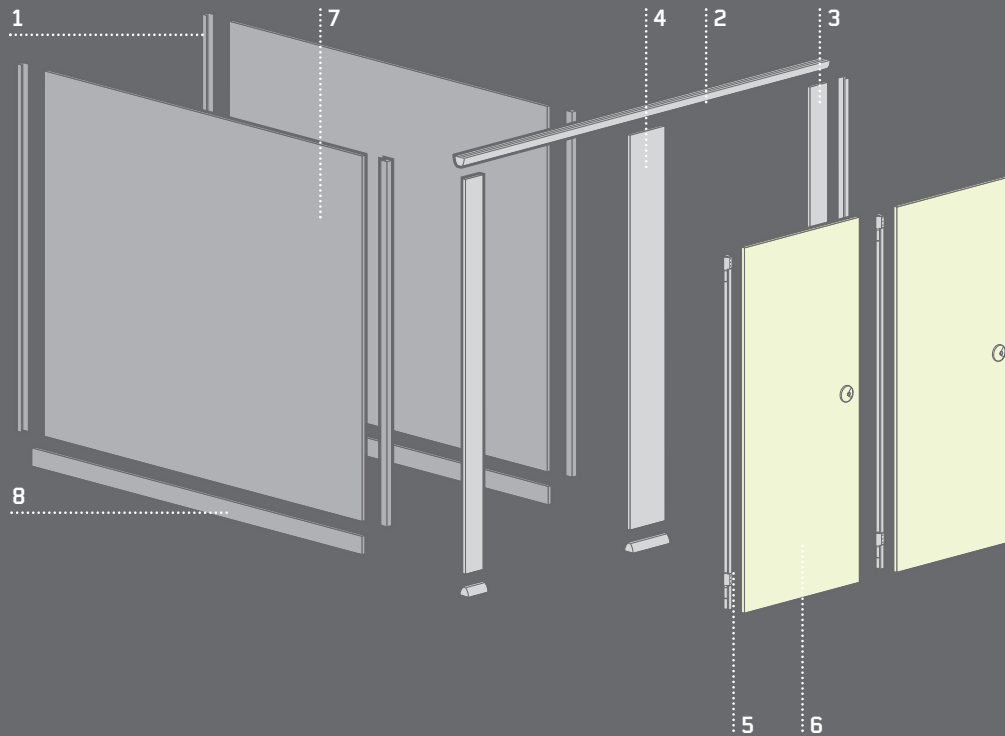

## Typical cubicle configurations

- 9 Between walls
- 10 Against walls
- 11 Oversized between walls
- 12 Oversized against walls

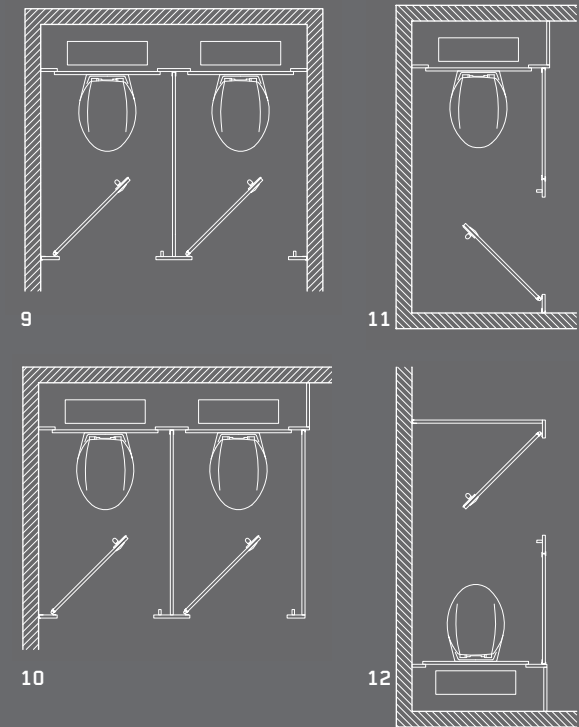

# Equality Act 2010

All Bushboard cubicles can be delivered to comply with Building Regulations Part M and the Equality Act 2010\*. We can help you with planning your washroom and the issues you need to consider.

## Enlarged

Where four or more cubicles are provided in a washroom one of these must be enlarged. Enlarged cubicles are there to assist the ambulant disabled, people with babies or small children and/or people with bags.

## Standard

A standard WC compartment must have a minimum 450mm diameter manoeuvring space within the cubicle. This is to be maintained between the swing of the door, the WC pan and the side wall of the compartment.

## Ambulant Disabled

Every same-sex washroom must have at least one WC compartment (cubicle) that is suitable for the ambulant disabled. If there is only one cubicle in the washroom then this must be suitable for an ambulant disabled person.

In addition the ambulant cubicle must provide the correct grab rails and inner pull handles – for more information see our accessories range (page 73).

## Light Reflectance Values

Consideration should also be given to colour contrast to aid partially sighted people. To help you when choosing your colour scheme our colours are graded with an LRV value.

\* It is the responsibility of the customer to work towards your obligation to the Equality Act 2010 and to comply with the latest Building Regulations Part M. We recommend you contact your Local Authority Access Control Officer.

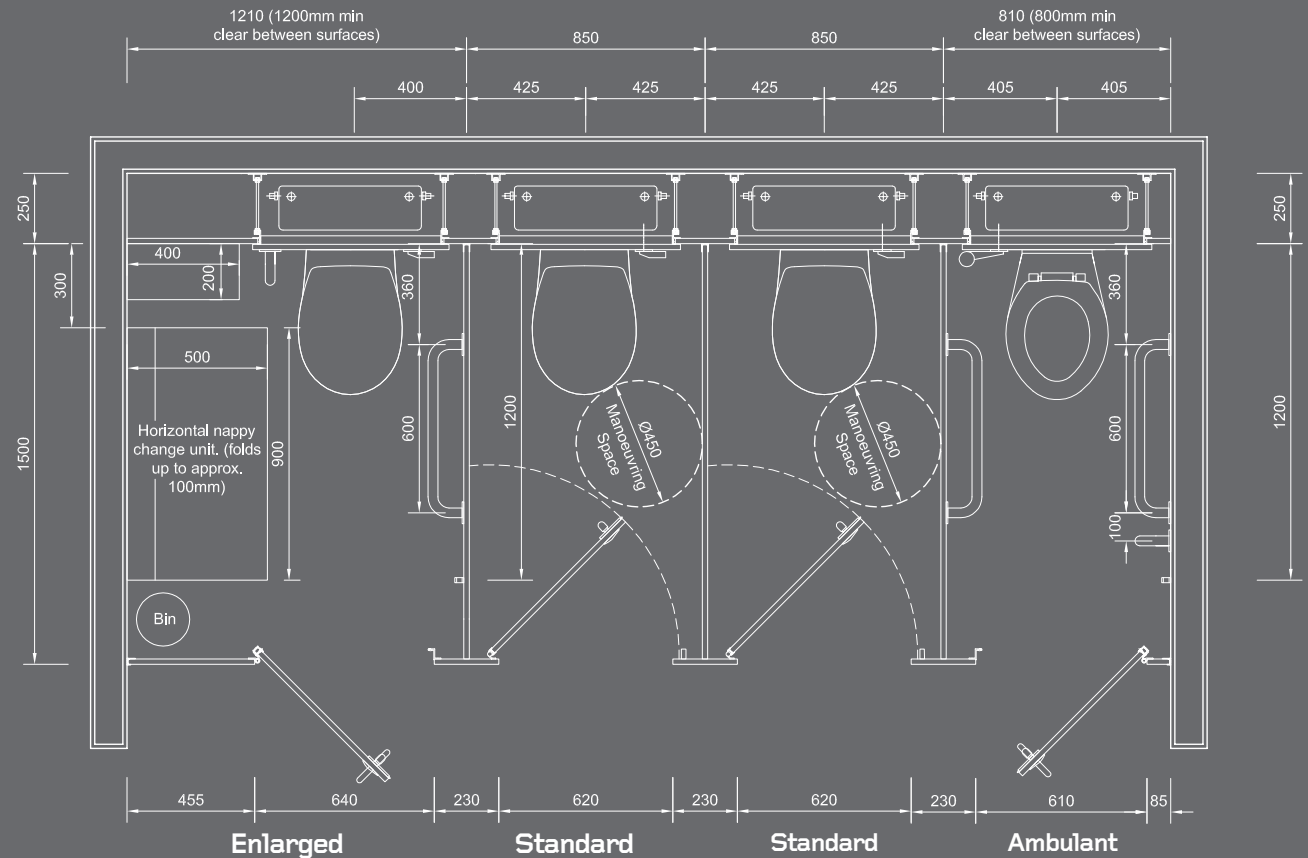

# Choose your ducting system



Marden Wall Hung Basin with Kludi Mini Lever mounted onto Warm Oak panels

Our ducting and access panel systems can be delivered in three ways.

Whether you choose our Ready Plumbed Modules, Ezeeduct, or panel only, we can deliver a flexible, cost-effective solution to suit your needs.



# The benefits of choosing Bushboard Ready Plumbed Modules

First designed nearly 10 years ago we wanted our RPM system to be the best pre-plumbed system on the market and today over 50,000 units are in use across the UK.

Changing the way washrooms are installed, pre-plumbed systems make duct fitting faster and easier. Delivered ready to install, each module combines a carefully selected range of sanitaryware and brassware fitted to panels and pre-assembled onto a rigid aluminium frame so on-site labour is kept to a minimum and the finished look is always first class.

→ **Guaranteed quality:**

a factory engineered solution that uses standardised processes and the latest manufacturing technology to deliver an exceptionally high quality, durable finished product

→ **Improved cost control:**

one product delivered from one source ensuring greater predictability of cost and programming

→ **Utilisation of off-site**

**skills:** removes the interface between joinery and plumbing trades reducing reliance on skilled labour on-site

→ **Improved sustainability:**

reduces the impact of construction activities on-site including noise, vehicle movements and waste reduction

→ **Reduced accidents:**

transferring work off site into our controlled production environment reduces site health and safety issues

→ **Reduced costs:**

our independent research proves RPM is up to 20% cheaper than traditional timber frame and panelling\*

→ **Time savings on-site:**

delivered ready to fit, RPM is proven to be up to 75% faster to install than traditional timber frame and panelling\*

→ **Testing off-site:**

units are pressure tested prior to delivery to ensure they are ready to install

→ **Delivery and distribution:**

units delivered palletised for ease of handling and distribution on-site

## Hinged and lockable access panels

The RPM extruded aluminium frame has been specifically designed to incorporate hinged panels to meet the increasing demand for quick and easy access to essential services for routine maintenance.

In addition, hinges make for easier manual handling and because panels are not completely removed to access pipework, any risk of damage or water ingress from potentially wet floors is eliminated.

The option of locks is ideal for areas where security is paramount.

Please note: Hinged panels available at a minimum height of 400mm and a maximum width of 700mm. Panels above 1500mm high must have 2 locks.



- 1 Hinged and lockable access panels
- 2 MFC and HPL hinge in pressed steel
- 3 SGL hinge in industrial nylon and extruded aluminium
- 4 Optional locks

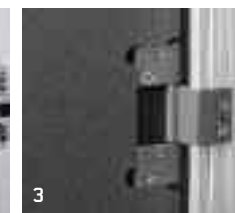

# Ready Plumbed Modules – Technical overview

These pre-plumbed units come complete with panels, sanitaryware, brassware and plumbing all assembled onto a rigid aluminium frame ready to install. All Bushboard wall hung WCs are factory fitted prior to delivery. Floor mounted back to wall WCs are supplied separately for on-site fixing.

Please note we have a range of HTM 64 and 68 compliant Ready Plumbed Modules for Healthcare

## Specification Options

### → Performance

MFC  
HPL  
SGL  
Wood Veneer

### → Colours

Full colour range

### → We supply

Rigid aluminium frame  
Access panels  
Flashgap panels  
Powder coated skirting  
Panel fittings  
Pre-plumbed Sanitaryware  
Pre-plumbed Brassware

### → 1 Framing

Factory assembled rigid extruded aluminium frame

Integral rail for cisterns and sanitaryware

### → 2 Flashgaps

Supplied oversize for on-site adjustment

### → 3 Panels

Factory fitted access panels

### → 4 Plumbing

Pre-plumbed and pressure tested where appropriate

### → 5 Fittings

Push fit, lift off or hinged panel fittings

### → 6 Tiebacks

Threaded rods, adjustable in two planes, lock frame to the building structure

### → 7 Sanitaryware

A dedicated range of sanitaryware specifically chosen and tested for Bushboard RPM units

### → 8 Skirting

Aluminium skirting, pre-finished in Silver or Charcoal Grey Powder coat. Also available with flashgap skirting option.

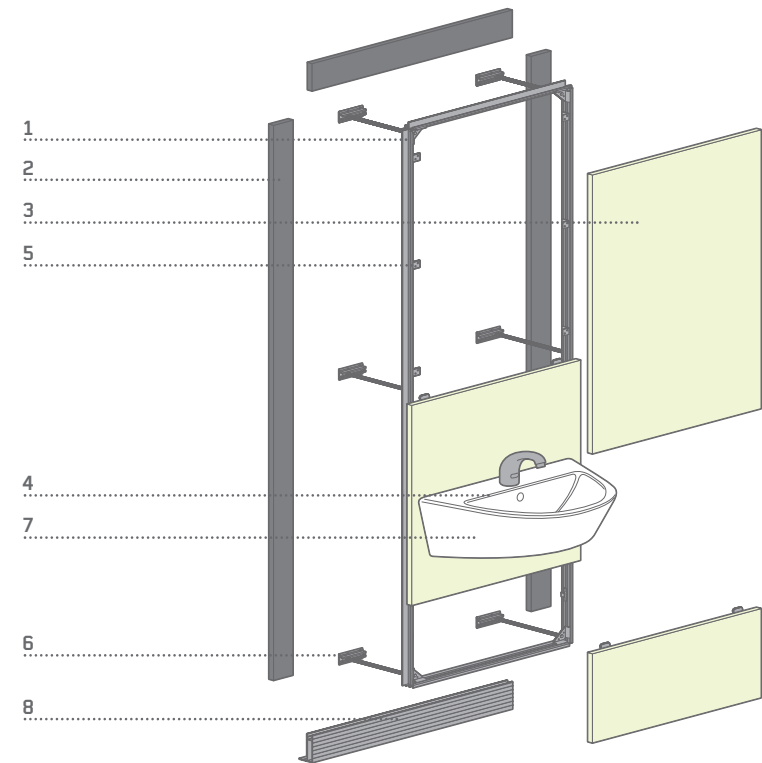

Plan view of RPM wall system

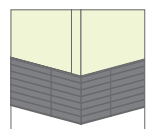
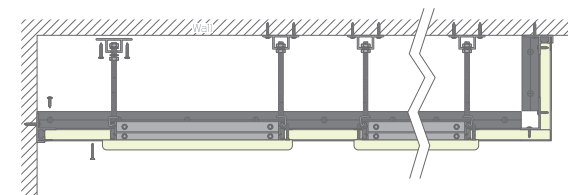

Moulded corner section for ease of installation

# Fast installation in 3 simple steps

## ➔ Step 1

### Preparation:

- ➔ Set out position of skirting, tie brackets and wall channel
- ➔ Fix skirting to floor
- ➔ Fix brackets to wall

Skirting can be provided at an earlier stage to enable installation of floor finishes.

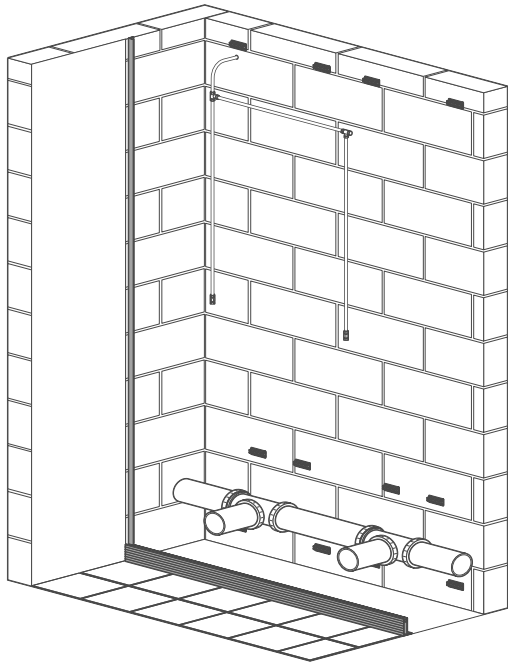

## ➔ Step 2

### Fixing the RPM units:

- ➔ Locate the RPM units onto skirting
- ➔ Lock tie bars onto wall mounted brackets

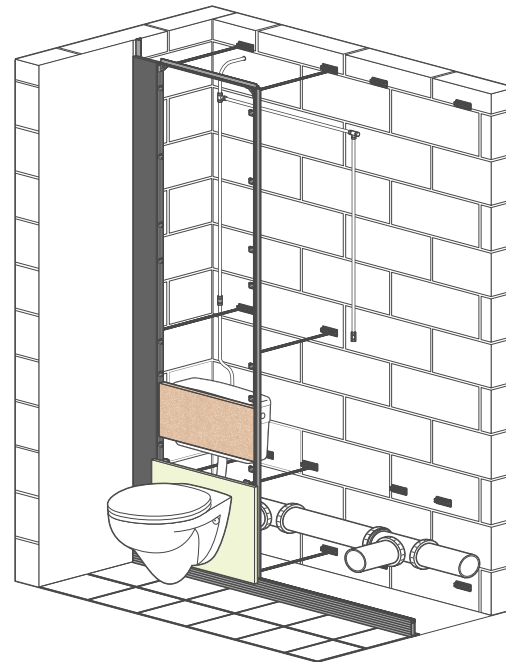

## ➔ Step 3

### Finishing:

- ➔ Cut and fit horizontal and vertical flashgap panels
- ➔ Connect services
- ➔ Refit access panels

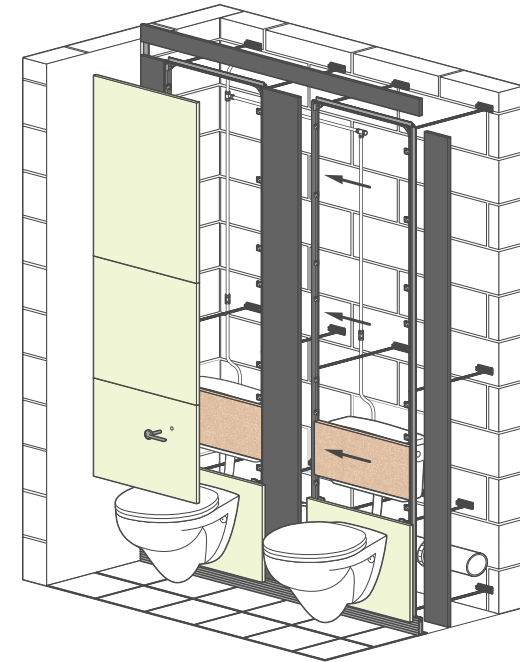

# RPM sanitaryware & brassware

**Guarantees:** Ceramic products are guaranteed for 25 years, Brassware is guaranteed for between 5 and 12 years dependent on manufacturer. Contact us for details.

With our extensive range of sanitaryware we can offer you our most cost-effective pre-plumbed system ever!

Working in partnership with a number of leading suppliers, we have carefully selected our range of sanitaryware and brassware with quality, durability and cost in mind.

## WCs – wall hung

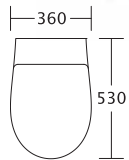

### Sola Rimless

Ultra hygienic. Totally rimless design. Concealed fixings. Exceptionally easy to clean.

**SA1738WH** Pan

**AV7865WH** Seat & cover, White

**AV7861WH** Seat only, White

**AV7861BE** Seat only, Blue

**AV7865BE** Seat & cover, Blue

6 litre or 4 litre cistern  
Installed pan height 400mm



### Galerie

Modern and affordable style. Smooth symmetrical lines.

**GN1738WH** Pan

**GN7865WH** Seat & cover

6 litre or 4 litre cistern.  
Installed pan height 400mm

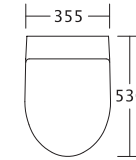

### Refresh

Smart and stylish. Smooth curved surfaces. Wrap over seat for total hygiene.

**RE1738WH** Pan

**RE7815WH** Seat & cover

6 litre or 4 litre cistern.  
Installed pan height 400mm

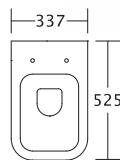

### Marden

Ergonomic modern styling.

**MDWCWHSTD** Pan

**MDSEATSTD** Seat & cover

6 litre or 4 litre cistern.  
Installed pan height 400mm

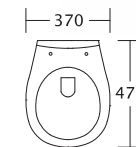

### Chartham

Ultra sleek smooth design.

**CHWCWHSTD** Pan

**CHSEATWHO** Seat & cover

6 litre or 4 litre cistern.  
Installed pan height 400mm

In partnership with:



It's thanks to these partnerships that we have the flexibility to provide a range of ready plumbed solutions to suit any project or budget whilst ensuring they are factory manufactured to the highest standards.

We can also help advise on how you can work towards achieving your BREEAM compliance. Contact us for more details.

For use with our RPM ducting, see page 46.

# WCs – back to wall

For use with our RPM ducting, see page 46.



**Avalon Rimless**  
For use in disabled areas.  
Complies with Doc M regulations.

- AV1968WH** Pan
  - AV7861WH** Seat only, White
  - AV7865WH** Seat & cover, White
  - AV7861BE** Seat only, Blue
  - AV7865BE** Seat & cover, Blue
- 6 litre or 4 litre cistern.  
Installed pan height 450mm



**Sola Rimless**  
Ultra hygienic. Totally rimless design. Exceptionally easy to clean.

- SA1968WH** Pan
  - AV7865WH** Seat & cover, White
  - AV7861WH** Seat only, White
  - AV7861BE** Seat only, Blue
  - AV7865BE** Seat & cover, Blue
- 6 litre or 4 litre cistern.  
Installed pan height 405mm

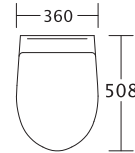

**Galerie**  
Modern and affordable style. Smooth symmetrical lines.

- GN1438WH** Pan
  - GN7865WH** Seat & cover
- 6 litre or 4 litre cistern.  
Installed pan height 400mm

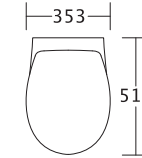

**Refresh**  
Smart and stylish. Smooth curved surfaces. Wrap over seat for total hygiene.

- RE1438WH** Pan
  - RE7815WH** Seat & cover
- 6 litre or 4 litre cistern.  
Installed pan height 390mm

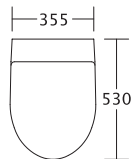

**Marden**  
Ergonomic modern styling.

- MDWCBTWST** Pan
- MDSEATSTD** Seat & cover

6 litre or 4 litre cistern.  
Installed pan height 400mm

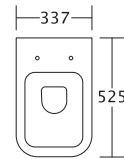

**Chartham**  
Ultra sleek smooth lines.

- CHWCBTWST** Pan
- CHSEATSTD** Seat & cover

6 litre or 4 litre cistern.  
Installed pan height 400mm

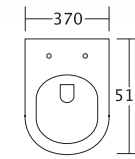

## WCs – back to wall

For use with our RPM ducting, see page 46.



**Chartham Rimless 700/750**  
HTM 64 compliant, rimless raised height.

**CHWCBTW70** Pan

**CHWCBTW75** Pan (DOC M)

**CHSEATSPW** Seat only, White

**CHSEATSPB** Seat only, Blue

**CHSEATSPS** Soft Close Seat & cover, White

6 litre or 4 litre cistern.  
Installed pan height 450mm

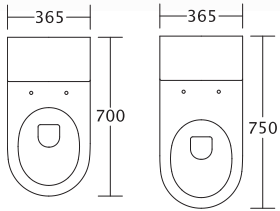

**Chartham Rimless 480**  
HTM 64 compliant, rimless raised height.

**CHWCBTW48** Pan

**CHSEATSPW** Seat only, White

**CHSEATSPB** Seat only, Blue

**CHSEATSPS** Soft Close Seat & cover, White

6 litre or 4 litre cistern.  
Installed pan height 450mm

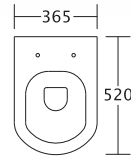

**Chartham Rimless Std**  
Rimless comfort height.

**CHWCBTW45** Pan

**CHSEATSPW** Seat only, White

**CHSEATSPB** Seat only, Blue

**CHSEATSPS** Soft Close Seat & cover, White

6 litre or 4 litre cistern.  
Installed pan height 425mm

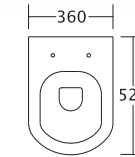

**Sola School Rimless 300/350**

Designed for schools.  
No hidden channels or dirt traps. Easy to clean.  
Blue seat option.

**SA1512WH** Pan (300)

**WC1514WH** Pan (350)

**SA1304WH** Seat only, White

**SA1306WH** Seat only, White full seat ring

**SA1304BE** Seat only, Blue

**SA1306BE** Seat only, Blue full seat ring

6 litre or 4 litre cistern.  
Installed pan height 300mm or 350mm

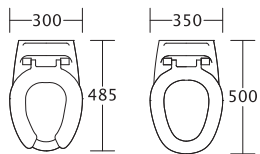

**Staple School Pan**

Designed for schools.  
Sleek smooth design with box flushing rim.

**SPWCBTWSH** Pan

**SPSEATSCH** Seat only, White

6 litre or 4 litre cistern.  
Installed pan height 350mm

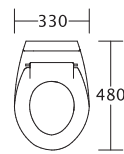

**Close Coupled Doc M Pack**

**SCDMCCLB** Left Hand, Blue

**SCDMCCLW** Left Hand, White

**SCDMCCR B** Right Hand, Blue

**SCDMCCR W** Right Hand, White

**Back to Wall Doc M Pack**

**SCDMBTWLB** Left Hand, Blue

**SCDMBTWLW** Left Hand, White

**SCDMBTWRB** Right Hand, Blue

**SCDMBTWRW** Right Hand, White

Individual grab rails are available.  
Contact us for details.

# Urinals

For use with our RPM ducting (see page 46).

Exposed waste in plastic. Choose either timed mechanical flush option or no-touch sensor.

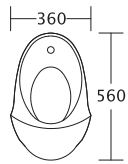

**Spectrum**  
Widely specified. Concealed inlet and back outlet makes spectrum ideal for environments prone to vandalism.

**VC7004WH**  
Projection 330mm

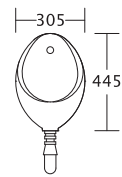

**Clifton**  
Compact design. Concealed inlet and exposed outlet. Deep bowl. Ideal for budget applications. Easy maintenance.

**VC7002WH**  
Projection 330mm

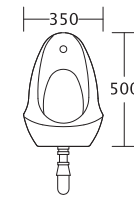

**Camden**  
Shallow bowl design. Concealed inlet and exposed outlet. Easy maintenance.

**VC7003WH**  
Projection 330mm

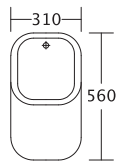

**Chartham**  
Concealed trap urinal with uniquely designed spreader.

**CHURINLCT**  
Projection 300mm

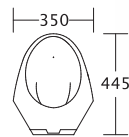

**Staple**  
Exposed trap urinal with unique bowl design for complete clean on each flush.

**SPURINEXP**  
Projection 330mm

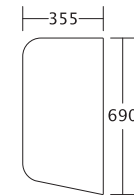

**Urinal Separator**  
Slim unbranded urinal separator.

**CHURINSEP**  
Projection 355mm

## Flushing options



**Chrome Plated Lever**  
For 6 litre cisterns



**Chrome Plated Extended Lever**  
For 6 litre cisterns



**No Touch Sensor**  
For WCs or Urinals



**Chrome Plated Push Button**  
For 6 litre cisterns



**Pneumatic Dual Flush Valve**  
For 6 litre and 4.5 litre cisterns



**Palm Push Button**  
For 6 litre cisterns

# Basins – wall hung

For use with our RPM ducting, see page 46.



**Sola**  
Deeper side walls for superior strength. Ultra hygienic. Enclosed fixings.

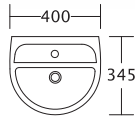

**SA4111WH (DOC M)**  
400mm 1 Tap hole

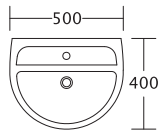

**SA4112WH**  
400mm 2 Tap hole

**SA4211WH**  
500mm 1 Tap hole

**SA4212WH**  
500mm 2 Tap hole



**Galerie**  
Modern and affordable style. Clean smooth lines.

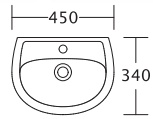

**GN4821WH**  
450mm 1 Tap hole

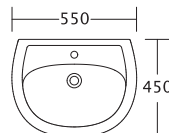

**GN4822WH**  
450mm 2 Tap hole

**GN4221WH**  
550mm 1 Tap hole

**GN4222WH**  
550mm 2 Tap hole



**Refresh**  
Smart and stylish. Smooth surfaces with deep rims.

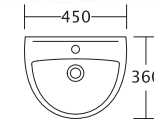

**RE4841WH**  
450mm 1 Tap hole

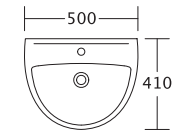

**RE4842WH**  
450mm 2 Tap hole

**RE4121WH**  
500mm 1 Tap hole

**RE4122WH**  
500mm 2 Tap hole



**Langley 400**  
Designer washbasin with distinctive slim styling.

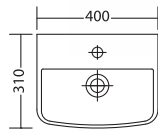

**LLBWH40CT**  
400mm Centre Tap hole



**Marden 520**  
Stylish, smooth modern design.

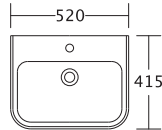

**MDBWH52CT**  
520mm Centre Tap hole



**Marden 420**  
Compact yet stylish modern design.

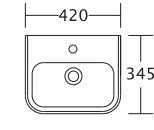

**MDBWH42CT**  
420mm Centre Tap hole



**Chartham 500**  
Washbasin with no overflow or chain hole.

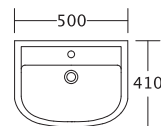

**CHBWH50RH**  
500mm Right Hand Tap hole

**CHBWH502T**  
500mm 2 Tap hole



**Chartham 450**  
Smooth design with centre taphole and overflow.

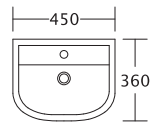

**CHBWH45CT**  
450mm Centre Tap hole

**CHBWH452T**  
450mm 2 Tap hole



**Chartham 380**  
Doc M compliant. Washbasin with no overflow or chain hole.

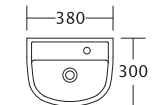

**CHBWH38RH**  
380mm Right Hand Tap hole

**CHBWH38LH**  
380mm Left Hand Tap hole

## Basins – semi recessed

For use with our semi-recessed vanity range, see page 60.

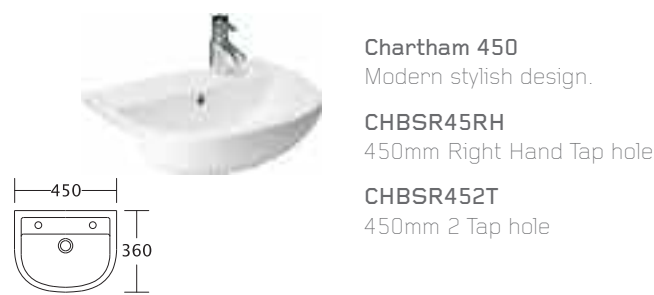
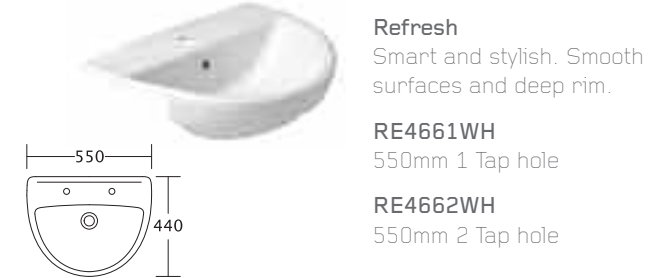

## Basins – counter top

For use with our counter top vanity range, see page 59.



# RPM brassware

## Mixer taps



Siron Side Lever  
SN5526CP



Basin Mixer  
SCTMIXSC1



Vision  
Non-Concussive  
VSN123



Insignia Lever  
INS113



Kludi Mini Lever  
KLTAPMINI



Siron Top Lever  
SN5126CP



Siron Top Lever  
Optimise  
SN5129CP



Swoop Luxury Lever  
SWO113  
Swoop Vessel Lever  
SWO113EX



Aquarius Premier  
AQ5128CP



Adore Klick Lever  
ADORE113EK

## Sensor taps



Sensor Tall  
SENSOR 3/D



Sensor Basin  
SENSOR 1/D



No Touch Classic  
AT01-001



Aquarius Wall  
Sensor Spout  
200mm\*  
AT02-011



Aquarius A45  
Basin Mounted  
AT03-021

\* For use with washtroughs.

Solid Surface Washtrough in Elysian  
with Swoop Luxury Lever Taps



## Pillar taps



Press Action

SF2101CP  
Single

SF2102CP  
Pair



Self Closing

NCT001  
Pair



DLT Short Lever

DLT101  
Pair



Insignia Lever

INS101  
Pair



Crux Luxury  
Crossheads

CRUX 101  
Pair

# Ezeeduct – Technical overview

Choose Ezeeduct and you gain all the features and benefits of RPM combined with your own sanitaryware and brassware choice. For cost effectiveness you can even reuse existing sanitaryware with Ezeeduct.

## Specification Options

### → Performance

MFC  
HPL  
SGL  
Wood Veneer

### → Colours

Full colour range

### → We supply

Rigid aluminium frame  
Access panels  
Flashgap panels  
Powder coated skirting  
Panel fittings

### → You supply

Sanitaryware  
Brassware

### → 1 Framing

Factory assembled rigid extruded aluminium frame. Integral rail for cisterns and sanitaryware.

### → 2 Flashgaps

Supplied oversize for on-site adjustment.

### → 3 Panels

Factory fitted access panels suitable for use with your own sanitaryware and brassware.

### → 4 Fittings

Push fit, lift off or hinged panel fittings.

### → 5 Tiebacks

Threaded rods, adjustable in two planes, lock frame to the building structure.

### → 6 Skirting

Aluminium skirting, pre-finished in Silver or Charcoal Grey powder coat. Also available with flashgap skirting option.

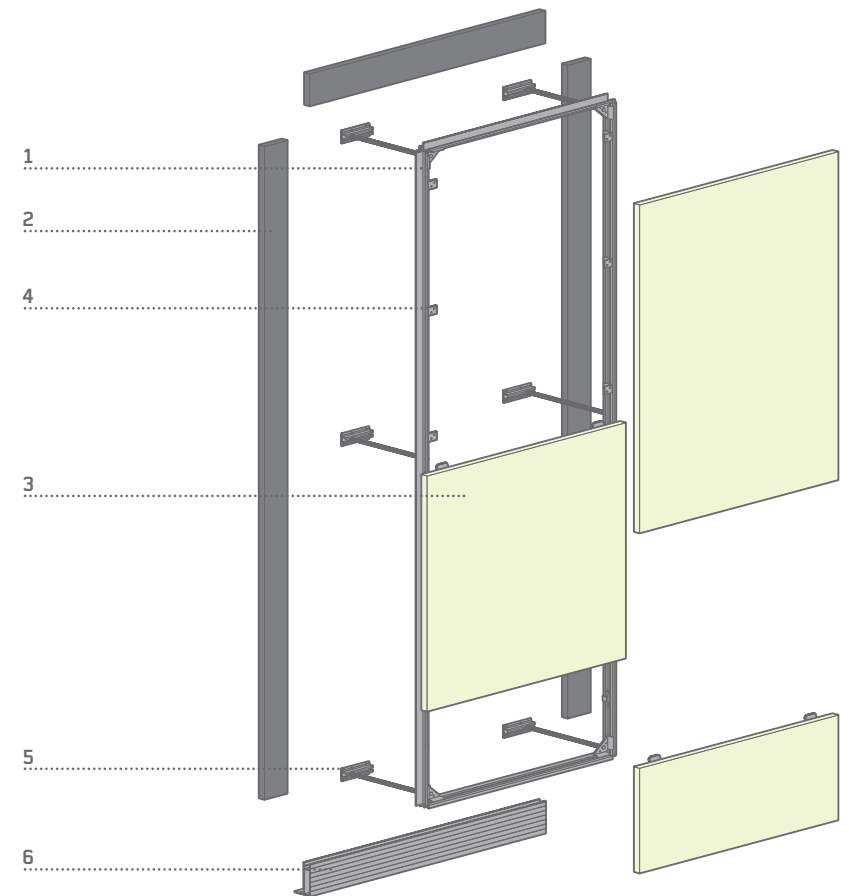

# Panel only – Technical overview

Our panel only option allows you to use our ducting and access panels with your own on-site timber framing, sanitaryware and brassware.

Our panels are available with either lift off or push fit clips determined by panel position. For added security and easy access choose hinged lockable access panels.

## Specification Options

### → Performance

MFC  
HPL  
SGL  
Wood Veneer

### → Colours

Full colour range

### → We supply

Access panels  
Flashgap panels  
Panel fittings

### → You supply

On-site framing  
Sanitaryware  
Brassware  
Skirting

### → 1 Flashgaps

Supplied oversize for on-site adjustment

### → 2 Panels

Suitable for use with your chosen sanitaryware and brassware.

### → 3 Fittings

Push fit or lift off.

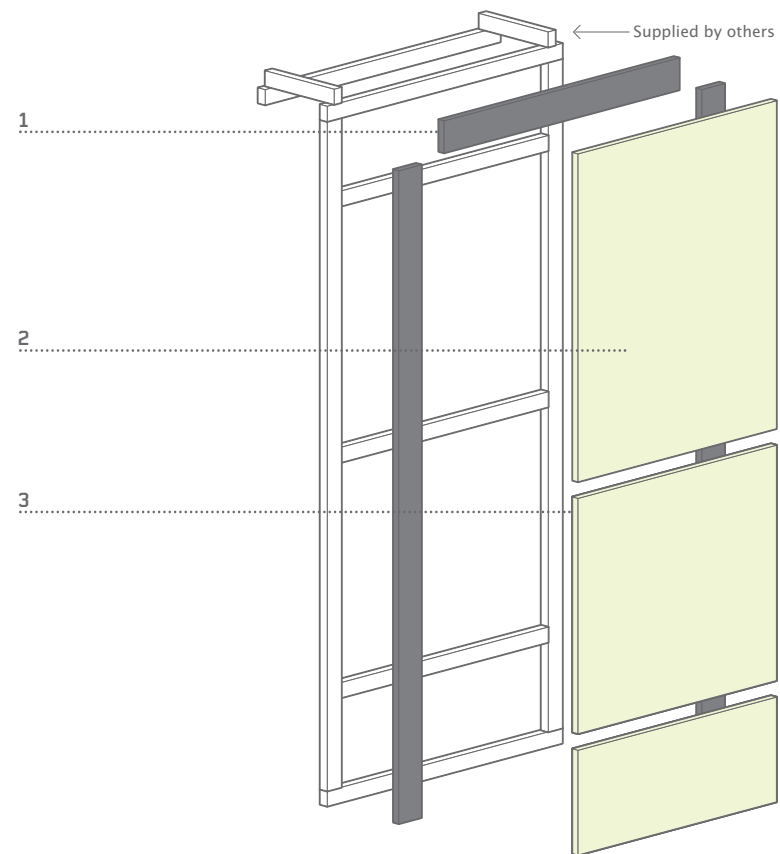

# Choose your vanity system



Solid Surface Vanity in Elysian with Integral Basin and Insignia Lever Tap; Frame and Panels in Aubergine

Whether you are designing a highly luxurious washroom or are looking for understated simplicity, our contemporary range of vanity units are smart, clean and practical.

Choose Counter Top, Semi-Recessed, Cantilever or our luxurious Solid Surface Washtrough.



# Counter top vanities

Smart and hardwearing, our counter top vanity units create depth and deliver additional space.

Available with a solid surface top and integral basin for the sleekest of finishes.

## Specification Options

### → Performance

Vanity top: HPL, SGL or Solid Surface  
 Vanity underpanel: MFC, HPL, SGL or Wood Veneer

### → Upstand

With or without upstand

### → Vanity ends

With or without finished ends

### → Colours

Top: 36 Laminate Colours,  
 10 Solid Surface Options  
 Underpanels: 36 Laminate Colours,  
 Wood Veneer Selection

### → Dimensions

Bed depth		555mm
Downstand		100mm
Optional upstand		75mm
Bed heights	Adult	800mm
	Junior	750mm
	Infant	675mm
	Nursery	600mm
Maximum bespoke lengths available in 1 section:		
	HPL	3000mm
	SGL	2500mm
	SS	3000mm



1 Counter top vanity in Welsh Slate and Oasis

2 Upstand detail

3 Dimensions

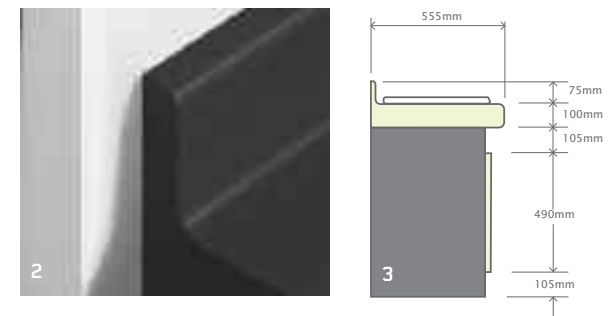

Please note: Wood Veneer underpanels may require additional protection from water ingress. Contact us for details.

# Semi-recessed vanities

Slim and stylish, our semi-recessed vanity units are ideal for areas where space is tight.

The universal style makes these simple yet functional units perfect for any washroom environment.

## Specification Options

### → Performance

Vanity top: HPL, SGL or Solid Surface  
 Vanity underpanel: MFC, HPL, SGL or Wood Veneer

### → Upstand

With or without upstand

### → Vanity ends

With or without finished ends

### → Colours

Top: 36 Laminate Colours,  
 10 Solid Surface Options  
 Underpanels: 36 Laminate Colours,  
 Wood Veneer Selection

### → Dimensions

Bed depth		350mm
Downstand		300mm
Optional upstand		75mm
Bed heights	Adult	800mm
	Junior	750mm
	Infant	675mm
	Nursery	600mm

Maximum bespoke lengths available in 1 section:

HPL	3000mm
SGL	2500mm
SS	3000mm



1 Semi-Recessed HPL Vanity Unit, Vanity Top and Carcass in Zest

2 Upstand detail

3 Dimensions

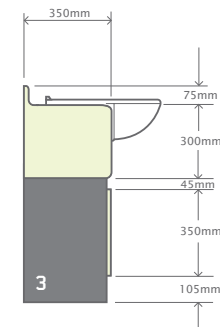

Please note: Wood Veneer underpanels may require additional protection from water ingress. Contact us for details.

# Washtrough

A sleek and modern design, our luxurious solid surface Washtrough will add a touch of elegance to any washroom.

Superbly crafted from an advanced composition of minerals and acrylic polymers, it delivers a seamless finish that is exceptionally hardwearing.

Available with cantilever fittings for the ultimate in minimalist style, or with underframe and panels for a contemporary spin on the traditional washroom environment.

## Specification Options

### → Performance

Trough: Solid Surface  
Underpanels: MFC, HPL or SGL or Wood Veneer

### → Vanity ends

Trough: Finished ends  
Underpanels: With or without finished ends

### → Colours

Trough: 10 Solid Surface options  
Underpanels: 36 Laminate Options  
Wood Veneer Selection

### → Dimensions

Bed depth*	Min.	350mm
	Max.	555mm
Downstand*	Min.	200mm
	Max.	250mm
Bed height		800mm
Maximum length available in 1 section:		2100mm



- 1 Solid Surface Washtrough in Elysian
- 2 Washtrough with Wall Mounted Taps
- 3 Washtrough with Deck Mounted Taps
- 4 Underframe trough with Wall Mounted Taps
- 5 Underframe trough with Deck Mounted Taps

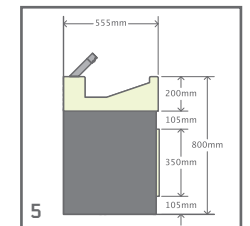
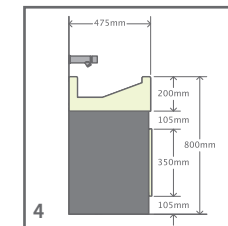
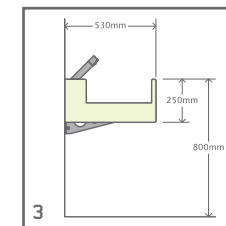
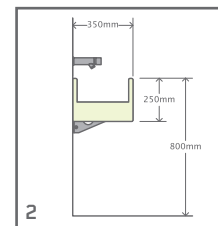

Please note: Wood Veneer underpanels may require additional protection from water ingress. Contact us for details.

\* These dimensions are dependent on fixing method and brassware choice; see dimension illustrations for more information.

# Cantilever

Elegant and understated, our stunning Cantilever vanities offer the perfect finishing touch to the most prestigious of washrooms.

Fabricated from our flawless solid surface composite, vanities are fixed with concealed cantilever brackets delivering a finish that is complete simplicity.

Available in both semi-recessed and counter top styles, Cantilever offers a modern alternative to the traditional vanity unit.

## Specification Options

### → Performance

Solid Surface

### → Upstand

With or without upstand

### → Vanity ends

With finished ends

### → Colours

10 Solid Surface Options

### → Dimensions

Bed depth	Semi-recessed	350mm
	Counter top	555mm
Downstand	Semi-recessed	300mm
	Counter top	100mm
Bed height		800mm
Maximum length available in 1 section:		3000mm



1 Solid Surface Cantilever Vanity in Drift

2 Semi-Recessed Cantilever

3 Counter Top Cantilever

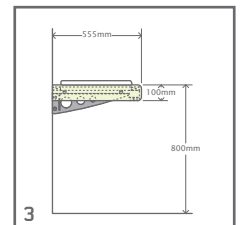
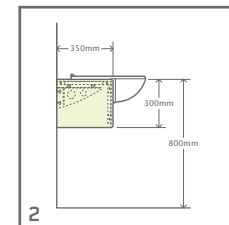

# Vanity options

## ➔ RPM

Ready Plumbed Modules combine a dedicated range of sanitaryware and brassware with the simplicity of our vanity top, underframe and panels.

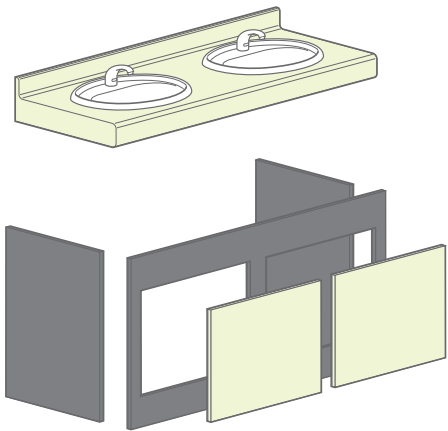

### We supply:

- ➔ Vanity top
- ➔ Sanitaryware
- ➔ Brassware
- ➔ One piece vanity underframe
- ➔ Underpanels

## ➔ Ezeevanity

Ezeevanity delivers all the benefits of RPM but for use with your own or existing sanitaryware.

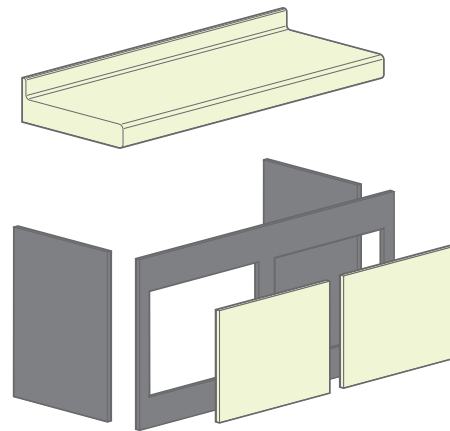

### We supply:

- ➔ Vanity top
- ➔ One piece vanity underframe

### You supply:

- ➔ Sanitaryware
- ➔ Brassware

## ➔ Panel only

Panel only offers you the flexibility of installing your own timber framework on-site.

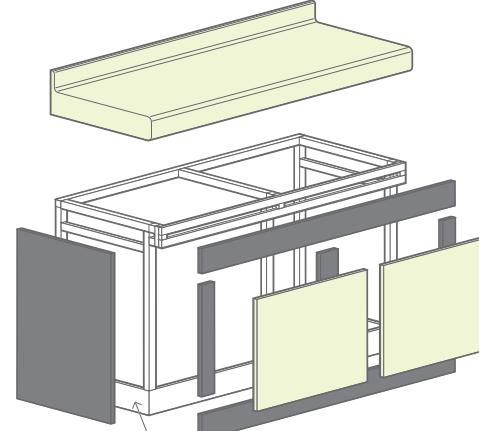

Supporting framework supplied by others

### We supply:

- ➔ Vanity top
- ➔ Flashgaps
- ➔ Underpanels

### You supply:

- ➔ Timber frame construction
- ➔ Sanitaryware
- ➔ Brassware

## ➔ Baby change

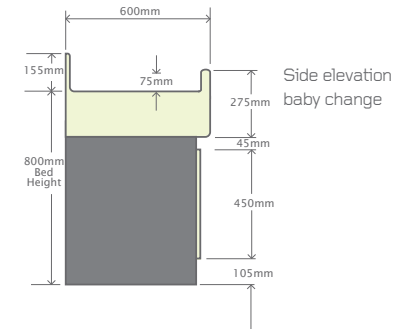

## ➔ Light pelmets

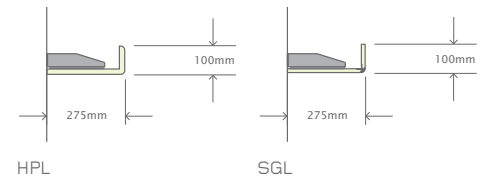

HPL

SGL

## ➔ SGL extrusions

All SGL vanity unit profiles are linked using aluminium extrusions in Silver or Charcoal Grey powder coat.

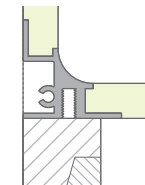

Rear upstand extrusion

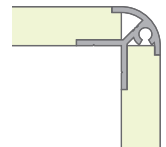

Front downstand extrusion

# Fastrack



**A complete off-the-shelf washroom in 48 hours\***

Fastrack is one of the most comprehensive fast-delivery washroom ranges available.

Including cubicle, ducting and vanity unit, Fastrack is a stylish, durable and economical washroom for dry areas, delivered box packed for easy handling.

Panels are cut to size on-site and edges concealed in continuous channels.

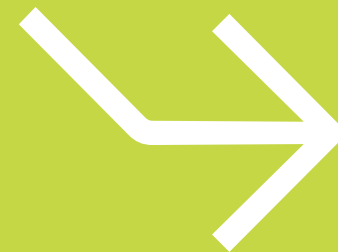

# Fastrack cubicle

A stylish and economical cubicle featuring durable dark grey fixtures and fittings.

A choice of square edge or postformed pilasters is available as well as a children's height door and the option of enlarged and ambulant cubicles.

## Specification Options

- **Performance**  
MFC
- **Pilasters**  
Square edge with matching 1mm PVC tipping  
Postformed radius edge in HPL
- **Fittings**  
Dark Grey – see page 68
- **Height**  
Overall 1950mm
- **Floor clearance**  
150mm
- **Colours**  
6 colour options for all panels – see page 68
- **Service**  
Fastrack



- 1 Cubicles in Cream with Blue pilasters
- 2 Headrail
- 3 Pedestal Foot
- 4 Hinge
- 5 Wall channel and H section

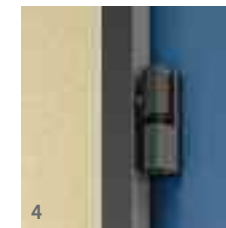

# Fastrack cubicles

- All components delivered to standard dimensions, boxed and clearly labelled
- Partitions and doors can be cut to size on site and edges concealed in channels
- Channels accommodate out of line walls
- Packs inclusive of detailed installation instructions

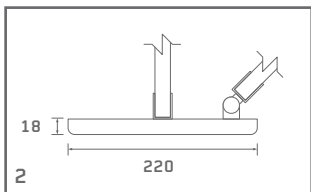
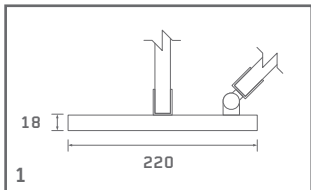
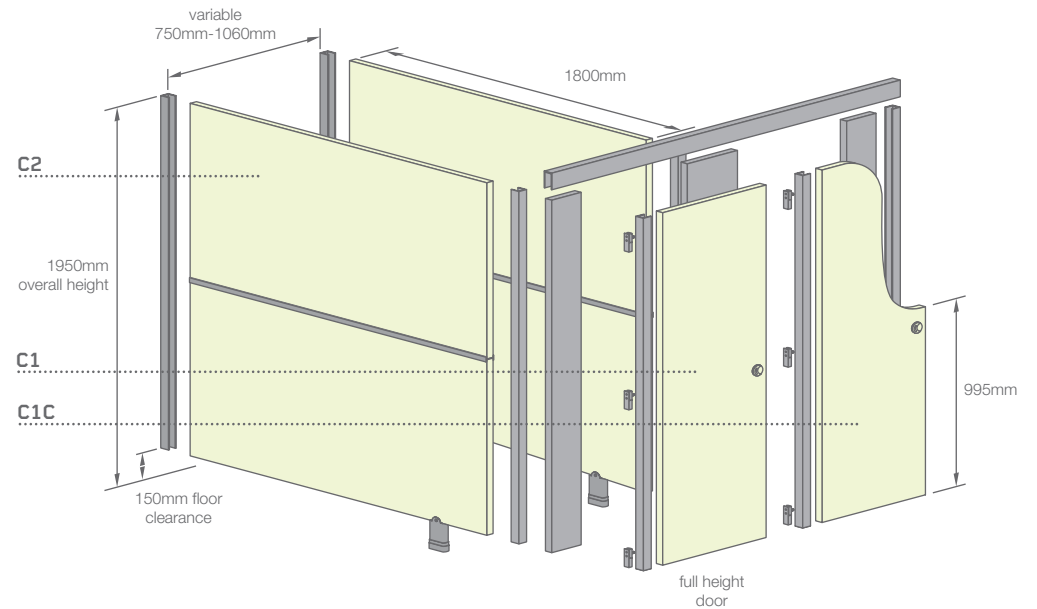

- 1 Square edged pilaster section in MFC
- 2 Postformed pilaster section in HPL

## C1 Door Pack with Square Edge Pilaster

Outward opening/inward opening  
Wheelchair, Ambulant and Enlarged

- 1 door 1800 x 900mm
- 1 pilaster 1800 x 220mm
- 1 pilaster drilled for hinge 1800 x 115mm
- 1 pilaster no hinge 1800 x 115mm
- 1 pilaster for enlarged cubicle drilled for hinge 1800 x 400mm
- 3 UPVC door cap/wall channels 1800mm
- 1 Aluminium headrail – Dark Grey 1800mm

## C1P Door Pack with Postformed Pilaster

Contents as C1 Pack but pilasters are Postformed.

## C1C Children's Door Pack with Square Edge Pilaster

- 1 door 1800 x 900mm
- 1 pilaster 1800 x 220mm
- 1 pilaster drilled for hinge 1800 x 115mm
- 1 pilaster no hinge 1800 x 115mm
- 1 pilaster for enlarged cubicle drilled for hinge 1800 x 400mm
- 3 UPVC door cap/wall channels 1800mm
- 1 aluminium headrail – Dark Grey 1800mm

## C1CP Children's Door Pack with Postformed Pilaster

Contents as C1C Pack but pilasters are Postformed.

## C2 Partition Pack

- 2 partitions "halves" 900 x 1800mm
- 1 UPVC H section 1750mm
- 1 UPVC door cap/wall channel 1800mm

## C3 Inline Pack with Square Edge Pilaster

- 1 large pilaster 1800mm x 900mm
- 1 pilaster drilled for hinge 1800 x 550mm
- 1 aluminium headrail – Dark Grey 1800mm

## C3P Inline Pack with Postformed Pilaster

As C3 Pack but pilasters are Postformed.

## C1FB Fittings Pack

- 1 ABS indicator bolt
- 1 outward keep
- 3 hinges Dark Grey
- 1 toilet roll holder
- 1 coat hook
- 2 aluminium pedestals
- Screws, plugs + channel through fixings

## GR1 Ambulant/Enlarged Grab Rail Pack

- 3 grab rails - White powder coated 600mm
- 2 door opening bars 300mm – Dark Grey powder coated
- 1 fixing pack complete

## C4 Floor to Ceiling Post

Required when ordering free standing cubicles.

- 1 floor to ceiling post 3750mm
- 2 flanges
- 1 UPVC door cap/wall channel 1800mm
- Screws, plugs + channel through bolt fixings

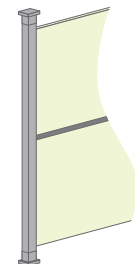

# Fastrack duct panels

Fastrack duct panels can incorporate most standard sanitaryware items.

- All components delivered to standard dimensions, boxed and clearly labelled
- Duct widths and heights can be varied by adjusting width of flashgaps
- Installer to provide appropriate timber frame to support duct panels (typically 50mm x 50mm softwood frame)
- Packs inclusive of detailed installation instructions

## Specification Options

- **Performance**  
MFC
- **Colours**  
6 colour options for all panels – see page 68
- **Service**  
Fastrack
- **Panels and flashgaps**  
Square edge with matching 1mm PVC lipping
- **Fittings**  
Lift off clips

## Standard Height

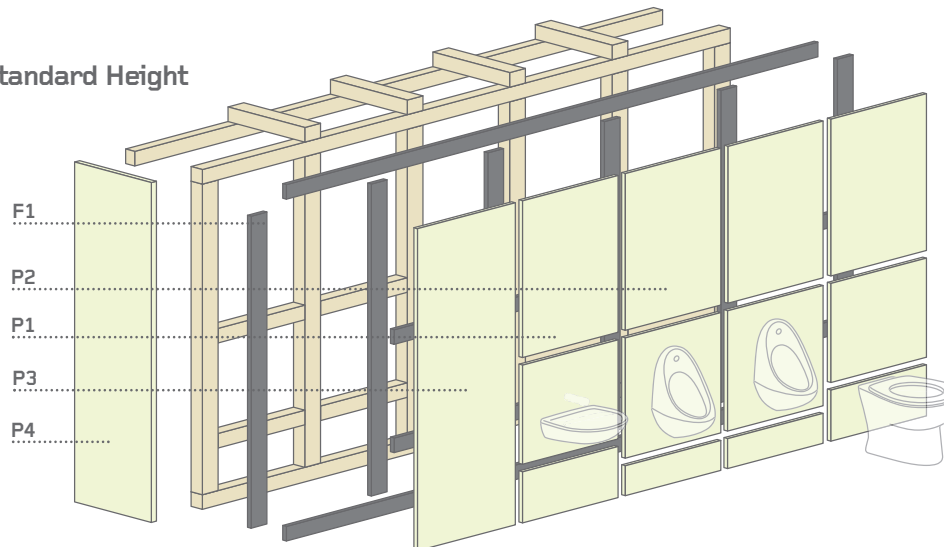

## Shelf Height

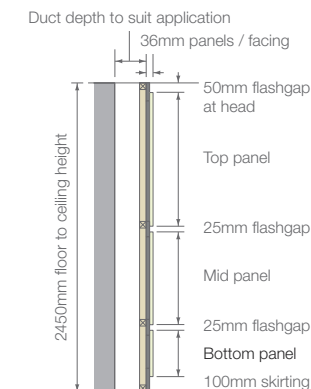
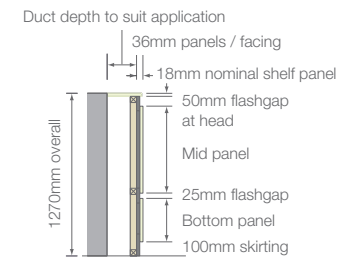
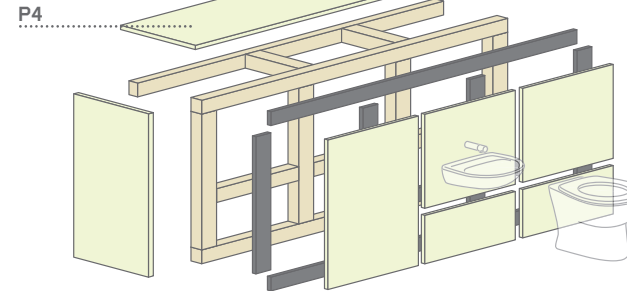

### P4 Plain Panel

- 1 2250 x 300mm full panel

### Plain Panel/Return End

- 1 2250 x 300mm full panel

### F1 Flashgap Pack

- 2 flashgaps – unedged 2600 x 200mm
- 1 flashgap – edged 2600 x 201mm
- 16 shrinkage plates + screws

### P1 Washbasin/WC Panel Pack

- 1 bottom panel 405 x 700mm
- 1 middle panel 670 x 700mm
- 1 top panel 1125 x 700mm
- 1 x 1mm PVC re-edging strip 2500mm
- 16 plastic clips + screws

### P2 Urinal Panel Pack

- 1 bottom panel 225 x 700mm
- 1 middle panel 850 x 700mm
- 1 top panel 1125 x 700mm
- 1 x 1mm PVC re-edging strip 2500mm
- 16 plastic clips + screws

### P3 Plain Panel

- 1 plain panel 2250 x 700mm
- 1 x 1mm PVC re-edging strip 2500mm
- 10 plastic clips and screws

### P4 Plain Panel

- 1 plain panel 2250 x 300mm
- 1 x 1mm PVC re-edging strip 2500mm
- 10 plastic clips + screws

All sanitaryware to be supplied by others.

© Bushboard Washroom Systems Ltd, 2012

# Fastrack vanities

- All components delivered to standard dimensions, boxed and clearly labelled
- For longer lengths units can be butt jointed/cut to length on site
- Packs inclusive of detailed installation instructions

## Specification Options

- **Performance**  
Vanity top: HPL  
Vanity underpanel: MFC
- **Colours**  
6 colour options for all panels – see below
- **Service**  
Fastrack
- **Upstand**  
Integral upstand
- **Dimensions**  
Length 1500mm  
Bed Depth 555mm  
Downstand 100mm

## V1 Vanity Unit

- 1500 x 555mm top with 75mm postformed upstand and 100mm downstand, returns and support brackets
- 2 loose underframe return ends 750 x 455mm
- 1 1380 x 645mm under panel
- Clips and screws
- 3 unedged flashgaps 1300 x 200mm
- 1 x 1mm PVC re-edging strip 1000mm
- Fixing brackets and screws

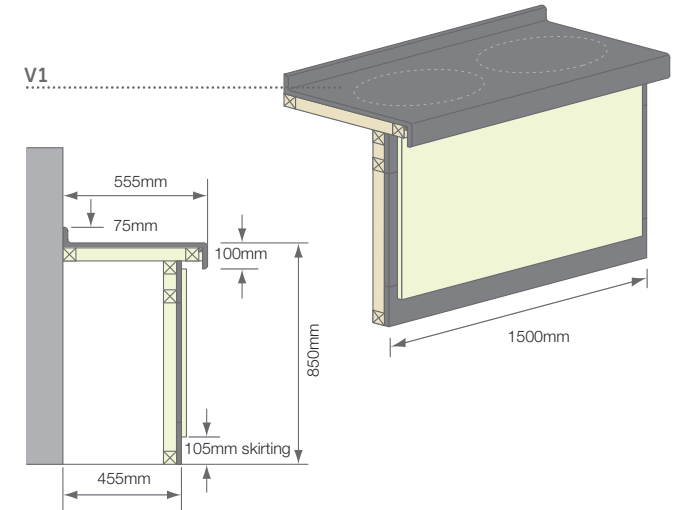

All sanitaryware to be supplied by others.

# Fastrack colours



Blue  
LRV 19.2

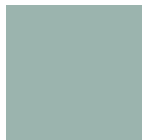

Green  
LRV 41.0

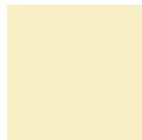

Cream  
LRV 75.7

Our colours are graded with a light reflectance value (LRV) to help ensure your washroom complies with current legislation.\*

\* contact your local access control officer



Light Grey  
LRV 43.4



Dark Grey  
LRV 12.3



Warm Oak  
LRV 34.5



Faceplate  
Dark Grey

# Cubicle fittings



Nylon Toilet roll holder



Nylon Coat hook



Exterior door handle



Internal Grab rail

See accessories page for more details.

# A step by step guide to selecting your Fastrack Washroom packs.

## Call our friendly sales team who will help to process your order on 01536 533620.

### ➔ 1 Cubicle selection

- ➔ Identify the layout of the cubicles you require from these four options and refer to the table next to it.
- ➔ Identify the number of cubicles you require along the top row of the grid.
- ➔ Read down the column to determine the pack and quantity you require.

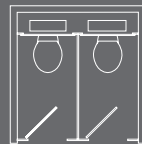

#### Between walls

No. cubicles	1	2	3	4	5	6	7	8
Door pack	1	2	3	4	5	6	7	8
Fittings pack	1	2	3	4	5	6	7	8
Partition pack	0	1	2	3	4	5	6	7
Floor/ceiling post pack	0	0	0	0	0	0	0	0
Max. width (mm)	1060	2120	3180	4240	5300	6360	7420	8480

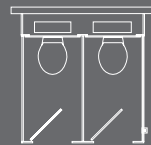

#### Freestanding

No. cubicles	1	2	3	4	5	6	7	8
Door pack	1	2	3	4	5	6	7	8
Fittings pack	1	2	3	4	5	6	7	8
Partition pack	2	3	4	5	6	7	8	9
Floor/ceiling post pack	1	1	1	2	2	2	2	2
Max. width (mm)	1060	2120	3180	4240	5300	6360	7420	8480

#### Against walls

No. cubicles	1	2	3	4	5	6	7	8
Door pack	1	2	3	4	5	6	7	8
Fittings pack	1	2	3	4	5	6	7	8
Partition pack	1	2	3	4	5	6	7	8
Floor/ceiling post pack	0	0	0	0	0	0	0	0
Max. width (mm)	1060	2120	3180	4240	5300	6360	7420	8480



#### Inline cubicles

	Between walls	Against walls
Door pack	1	1
Fittings pack	1	1
Partition pack	0	1
Max. length (mm)	2000	2000



Min. cubicle width 750mm

#### Options

- ➔ Children's door instead of standard door pack
- ➔ Door packs and in-line packs available with square edge pilaster or postformed pilaster
- ➔ Ambulant/enlarged grab rails and door opening bars are available separately.

### ➔ 2 Ducting selection

- ➔ For each range of panels determine how many you want of each type.
- ➔ Check they will fit in the space available.

Please note: Always leave a vertical gap 25mm wide between a panel and a wall. Leave a 25mm wide vertical gap between each panel. For WC panels, leave 50mm for fixing a cubicle partition. Plain panel packs P3 and P4 can be cut down and re-edged on site to cater for ranges that do not accommodate 700mm modules.

**For more information on junction details visit our website [www.bushboard-washrooms.co.uk](http://www.bushboard-washrooms.co.uk)**

Please note for each panel you will need one flash gap pack.

### ➔ 3 Vanity selection

- ➔ Determine how many vanity basins you require in each top.

1500mm long top	Up to 2 basins	Pack V1
-----------------	----------------	---------

- ➔ Check that the vanity top will fit into the available space.
- ➔ The vanity pack includes under panel, return end, flashgap and a fixing kit.
- ➔ Supporting timber framework to be supplied by site.

# Lockers and benching



Protec lockers are a flexible and secure locker system with a strong aluminium carcass and SGL doors making the whole system totally water resistant. Add a choice of benches selected to provide you with the most popular styles and you have the complete changing room offer.



# Protec® lockers

Featuring a satin anodised aluminium carcass providing a robust structure, each individual locker has an easy to clean injection moulded interior tray and anti-finger trap safety hinge to doors. With Protec it's simple. Choose your locker model, choose your locking system and select your door colour.

You can choose any combination of the six locker models to suit your installation. Lockers are delivered pre-assembled and ready to install in 4 weeks. For the electronic locking system a 5 week leadtime is required. For wet areas we suggest an additional base is provided.

## Service

All lockers are delivered pre-assembled and ready to install in 4 weeks. Lockers requiring electronic locking system require a 5 week leadtime.

## Locking mechanisms

We offer a range of lock options to suit most environments. For further information visit [www.bushboard-washrooms.co.uk](http://www.bushboard-washrooms.co.uk).



### Camlock

Simple and easy to use with red or blue wristbands.



### Padlock and hasp

An ideal solution for schools\*.



### Coin return

A popular choice.

### → 1 Panels

SGL for total water resistance and exceptional durability

### → 2 Carcass

Satin anodised aluminium provides robust structure

### → 3 Doors

SGL doors with integrated hinge design

### → 4 Tray

Easy to clean injection moulded interior trays

### → 5 Coat Hook

Integral coat hook to maximise internal space

### → 6 Locks

Choice of lock options

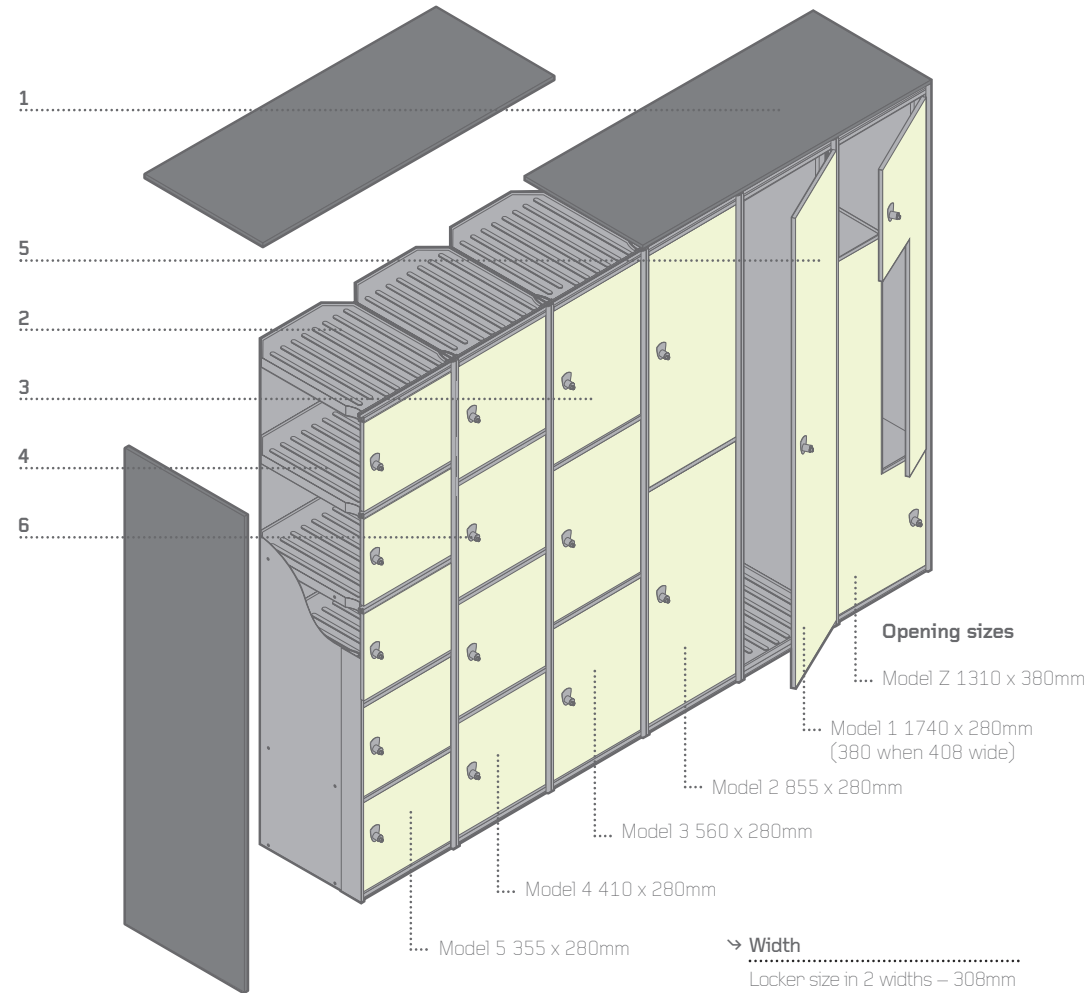

### Opening sizes

Model Z 1310 x 380mm

Model 1 1740 x 280mm  
(380 when 408 wide)

Model 2 855 x 280mm

Model 3 560 x 280mm

Model 4 410 x 280mm

Model 5 355 x 280mm

### → Width

Locker size in 2 widths – 308mm and 408mm

\*Z locker available in 408mm only

### → Height and depth

Overall locker height is 1800mm

Overall locker depth is 505mm

# Bench profiles

Our benches have been selected to provide the most popular styles for all types of installations.

Ash wood slats complemented by a dark grey nylon coated galvanised steel framework are supplied flat packed in 4 weeks. Slats are available in a range of lengths (1000mm\*, 1300mm, 1800mm and 2500mm) and can be cut to size and finished on-site for maximum flexibility.

## Locker Bench

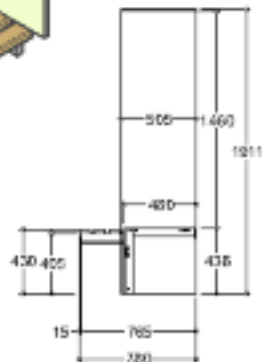
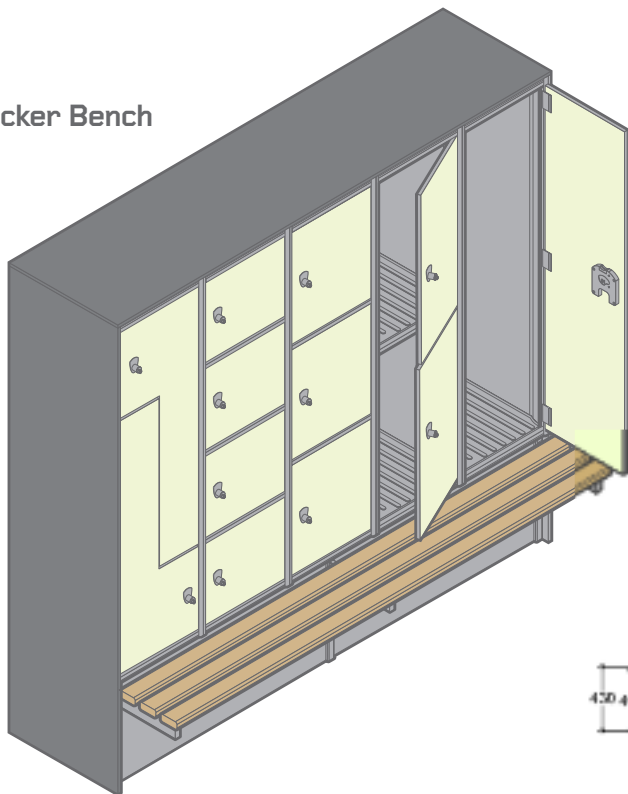

## Free Standing

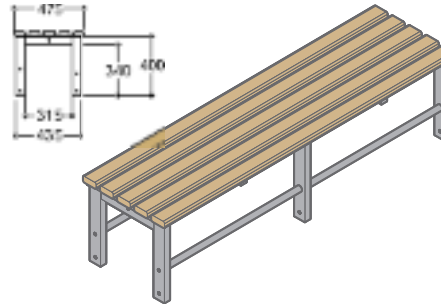

## Cantilever Perimeter\*\*

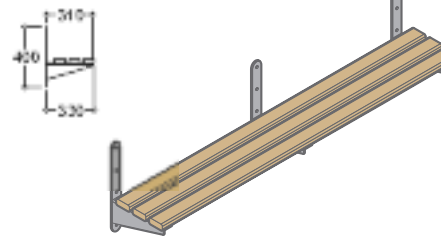

## Perimeter bench with legs \*\*

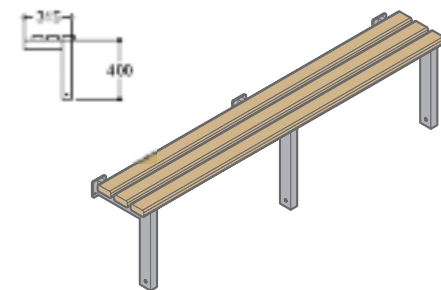

## Island with bench hooks

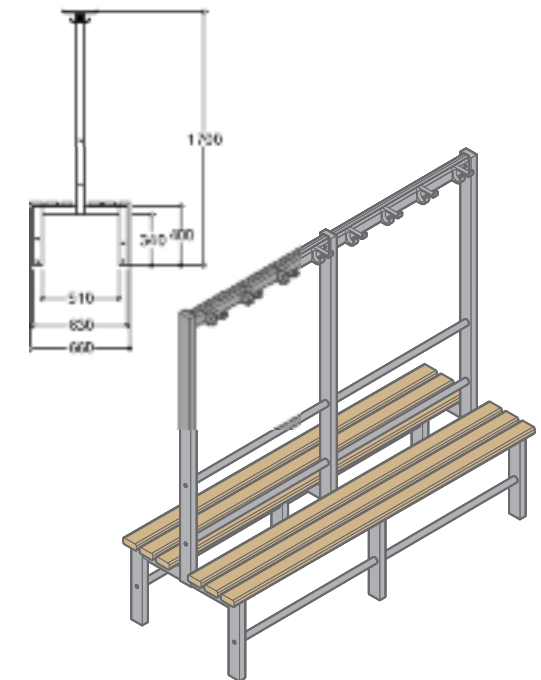

## Cubicle bench

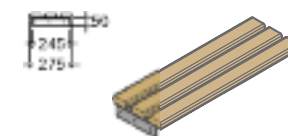

## Wall mounted coat hook

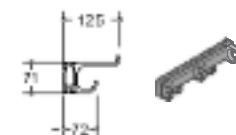

\* For cubicle benches only

\*\* Available in 3 or 4 slat options

# Accessories



**Cylindrical Liquid Soap Dispenser** 0302508  
Wall mounted. Stainless steel with chrome finish.

**Liquid Soap Dispenser** 0302532  
Polished chrome finish

**Liquid Soap Dispenser (Stainless Steel/White Metal)** 0302525/0302521  
Lockable, wall-mounted dispenser

**Light Grey Plastic Liquid/Foam Soap Dispenser** 0302513/0302514  
Wall-mounted grey plastic dispenser with stainless steel cover.

**White Plastic Liquid Soap Dispenser** 0302540  
Wall-mounted white plastic dispenser.



**Paper Towel Dispenser (Stainless Steel/White Metal)** 0302526/0302522  
Lockable, wall-mounted paper towel dispenser.

**Light Grey Plastic Paper Towel Dispenser** 0302519  
Wall-mounted grey plastic paper towel dispenser with stainless steel cover.

**White Plastic Paper Towel Dispenser** 0302537  
Wall-mounted white plastic paper towel dispenser.



**Jumbo Toilet Roll Holder (Stainless Steel/White Metal)** 0302527/0302523  
Lockable jumbo toilet roll holder.



**White Plastic Mid-Jumbo Toilet Roll Holder** 0302538  
Wall-mounted, white plastic mid-jumbo toilet roll holder.

**Light Grey Plastic Toilet Tissue Dispenser** 0302517  
Wall-mounted grey plastic toilet tissue dispenser.

**White Plastic Toilet Tissue Dispenser** 0302539  
Wall-mounted, white plastic toilet tissue dispenser.

**Stainless Steel Toilet Roll Holder (Single/Double)** 0302509/0302510  
Stainless steel toilet roll holder with concealed fixings.

**Aluminium Toilet Roll Holder (Dark Grey/Light Grey/Satin Chrome)** 0380082/0380081/0380080  
Cast aluminium toilet roll holder with lockable core.

**Nylon Toilet Roll Holder (White/Light Grey/Dark Grey)** 0300301/0300303/0300146  
Single nylon toilet roll holder with concealed fixings.

**Lockable Nylon Toilet Roll Holder (White/Light Grey/Dark Grey)** 0300401/0300403/0300147  
Single, lockable nylon toilet roll holder with concealed fixings.



**Stainless Steel Automatic Dryer** 0302019  
Automatic warm air dryer with brushed stainless steel finish.

**Silver Automatic Jet Dryer** 0302536  
High speed jet hand dryer with silver cover. Low energy consumption.



**White Metal Automatic Dryer** 0302005  
Automatic warm air dryer with white metal finish.

**Automatic High Speed Eco Dryer** 0302535  
Compact high speed silver hand dryer. Low energy consumption



**Stainless Steel Coat Hook** 0397094  
Stainless steel with integral rubber buffer in brushed satin finish.

**Aluminium Coat Hook (Light Grey/Dark Grey/Satin Chrome)** 0380066/0380067/0380065  
Lightweight aluminium with concealed fixings.

**Nylon Coat Hook (Dark Grey/Light Grey/White)** 0300137/0300139/0300201  
Lightweight nylon with concealed fixings.



**Back to Back Aluminium Door Handle (Silver/Charcoal)** 0182211/0182210  
400mm back to back fixing handle. DDA compliant.

**Stainless Steel Door Handle (Chrome/Satin)** 0182208/0182203  
400mm pull handle with concealed fixings.

**Bolt Through Aluminium Door Handle (Silver/Charcoal)** 0182213/0182212  
400mm bolt through handle. DDA compliant.

# Performance & delivery

## Real Wood Veneer

Medium use – Dry – Finished panel thickness 18mm\*

MDF faced both sides with Real Wood Veneer, suitable for dry environments with light to medium use. Panels supplied square edged with 3mm real wood veneer lipping.

## Melamine Faced Chipboard – MFC

Light to medium use – Dry – Finished panel thickness 18mm\*

High performance Melamine Faced Chipboard 630kg/m<sup>3</sup> density, moisture resistant, suitable for dry environments with light to medium use. Panels supplied square edged with matching 1mm PVC lipping.

## High Pressure Laminate – HPL

Medium use – Dry – Finished panel thickness 18mm\*

High Pressure Laminate bonded onto 630kg/m<sup>3</sup> density moisture resistant chipboard, suitable for dry environments with more intense use. Panels supplied square edged with matching 1mm PVC lipping or postformed vertical edges.

## Solid Grade Laminate – SGL

Heavy use – Wet or dry – Finished panel thickness 13mm\*

High density Solid Grade Laminate, 1400kg/m<sup>3</sup> impervious to water, suitable for the most demanding environments where strength and/or water resistance are needed. Polished radiused black edges as standard.

## Vanity Units

As well as High Pressure Laminate and Solid Grade Laminate, vanity tops are also available in Solid Surface.

## Solid Surface

Heavy use – Wet or dry

Solid surface is manufactured from an advanced composition of minerals and acrylic polymer that delivers a seamless finish to vanity tops and is exceptionally hardwearing.

## Delivery

Here at Bushboard, we are committed to ensuring your order is delivered on time, in full and in perfect condition. With this in mind we have invested in the latest manufacturing technology to ensure the entire process; from order to delivery; is as efficient as possible.

All of our panels are manufactured to your specific site dimensions and full CAD drawings are supplied with delivery. You also have the option to receive drawings for your approval prior to manufacture.

Contact us on 01536 533620 to find out more.

\* Nominal thickness

→ All lipping is applied with PUR adhesive

→ Real Wood Veneer, MFC and HPL are not suitable for use in wet environments

See our separate Colour Selector for our full range of panel colour options.

# Environmental

We understand the social and economic importance of protecting the environment and are fully committed to continually improving our environmental performance.

Certified as ISO 14001 compliant, we regularly assess the environmental impact of our business operations and take appropriate action to minimise any adverse impacts. Some of our resulting initiatives include:

- **Paperless Systems** – All of our quotes are emailed and our brochures are available electronically so we only print when absolutely necessary.
- **Waste Management** – Significant investment in the latest technology ensures that waste board material is kept to a minimum, whilst any that is produced is used as fuel for our biomass boiler.
- **FSC** – The real wood veneer used in our products is FSC certified, whilst any brochures we do print are on FSC accredited stock.
- **Reducing Carbon Emissions** – We have installed video conferencing facilities across all of our sites in order to minimise business travel.



Definition Cubicles with Marden Wall Hung Pan

Bushboard Washroom Systems Ltd  
Unit 1400 1st Floor Montagu Court  
Kettering Parkway  
Kettering Venture Park  
Kettering  
Northants  
NN15 6XR  
T 01536 533620  
F 01536 533648

washrooms@bushboard-washrooms.co.uk  
www.bushboard-washrooms.co.uk

After Sales and Customer Care  
T: 01536 533667

Colours in this brochure are as accurate as the printing process allows.  
Bushboard Washroom Systems Ltd reserves the right to alter or change  
specification without notice.

