



design technology function

collection 2014

Retail price list including VAT

The art of moving
water from the
earth to cleanse and
relax our bodies is
centuries-old.

Arte Form is a dynamic company, using innovative solutions in perfect balance between technology and design, guaranteeing high quality production. We blend the cornerstones of design, technology and function into products that utilise the latest manufacturing processes and materials that capture the imagination of world-renowned designers and architects.

Considerable investment into research and development allow us to follow trends that influence the market; ensuring a stylish, reliable and functional product.

welcome to arte form

The Arte Form collection is a range of high quality European designed and manufactured brassware

designs that stand out from the crowd



“Design is not just what it looks like and feels like.
Design is how it works.”
— Steve Jobs



We work closely with some of the top designers and architects across Europe, including Eduardo Souto De Moura – winner of the prestigious Pritzker Prize for Architecture in 2011, to deliver products that are designed both to satisfy the aesthetic criteria and meet our rigorous demands for function, efficient water usage, eco-friendly manufacture and long service life.

Throughout design development, the designers ensure there must be as minimal an impact on the environment as possible; both in the daily usage of the product, and also in the whole process of manufacture and the materials used — only then does it truly become an Arte Form design.

design

Design is the first part of the process towards producing an Arte Form product. With over 20 years' experience in the UK bathroom industry, we know a product not only needs to look good, it must withstand the rigours of everyday life.

“Everything is designed.
Few things are designed well.”

A designer knows
perfection is achieved
not when there is
nothing left to add, but
when there is nothing
left to take away.

The Arte Form collection is produced in collaboration with our three carefully selected European manufacturing partners. Each has an outstanding pedigree in both the design and production of luxurious, high quality bathroom fittings.

RUBINETTERIE
treemme



waterrevolution

Products bearing the Eco Energy System logo are marked as Made in Italy, indicating that they are made in the EEC and serves as a guarantee that manufacturing processes and use of materials meet European standards.

Our design teams are also challenged with ensuring that the same environmental considerations are applied beyond the product itself. The packaging is produced from either already recycled material, FSC approved sources or easily recyclable plastics. Even this brochure is designed to have minimum environmental impact. The paper is recycled and the inks are vegetable dyes.





technology

from the earth...

Arte Form use Marine Grade SAE 316 and 304 stainless steel in the production of taps, showerheads and accessories. Stainless steel is hygienic, hard wearing, easy to clean and is environmentally friendly in its production process.



Traditionally, varying levels of lead have been added to brass to aid the workability of the raw material. Following a large investment in the latest computer controlled machinery and processes, Arte Form products are now produced with either low lead or lead free brass that meets the latest US & EU directives on lead content.



Ranges bearing the lead free icon are manufactured from either stainless steel or lead free brass. These materials exceed even the current US legislation for low lead brass which allows for 0.25% lead content in brass.



to the machine...

The latest in computer controlled machinery manufactures to tolerances as low as 5 microns. This process is designed to minimise waste and energy use. Any brass waste from the manufacturing process is recycled and reused.



Arte Form Thermo products feature thermostatic mixing to maintain the perfect showering or bathing temperature. They also feature a maximum temperature stop to prevent excessive temperature being selected.



Arte Form utilise the latest water saving cartridges. They are matched to specific aerators that mix air into the water to produce a splash free, full stream of water even at reduced flow rates.

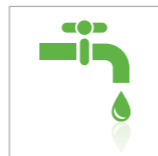

...to the finished form



function

“Simplicity is the
ultimate sophistication”
— Leonardo da Vinci

Thermostatic or manual mixing valves?

Manual mixing valves work like a basin mixer tap, once a temperature and flow have been selected, you would have to make any adjustments yourself to maintain this level if there are any changes in the pressure or temperature of the incoming hot or cold water supply.



Thermostatic mixing valves will automatically maintain the selected temperature and adjust the blend of hot and cold water to compensate for any fluctuations in the incoming water supply.

Water saving

Arte Form products are all installed with the latest water saving cartridges to reduce water consumption, they are matched to specific aerators that mix air into the water to produce a splash free, full stream of water even at reduced flow rates.



EasyBox system

Arte Form recessed shower valves utilize the EasyBox fitting system. The valve is mounted on a fixing backplate to enable easy, secure mounting in the wall. The valve body is protected by a polystyrene box to prevent damage during installation. Once installation is completed the front of the EasyBox system is removed to allow fitting of the finishing trim set.



Minimum water pressure

In order to ensure you get the best performance from your Arte Form products we have listed minimum recommended water pressures for each product.



Guarantee

All Arte Form products carry a full 15 year guarantee which covers any manufacturing defects. Cartridges and shower hoses carry a 5 year guarantee. In hard water areas cartridges may need extra cleaning as part of routine product maintenance.

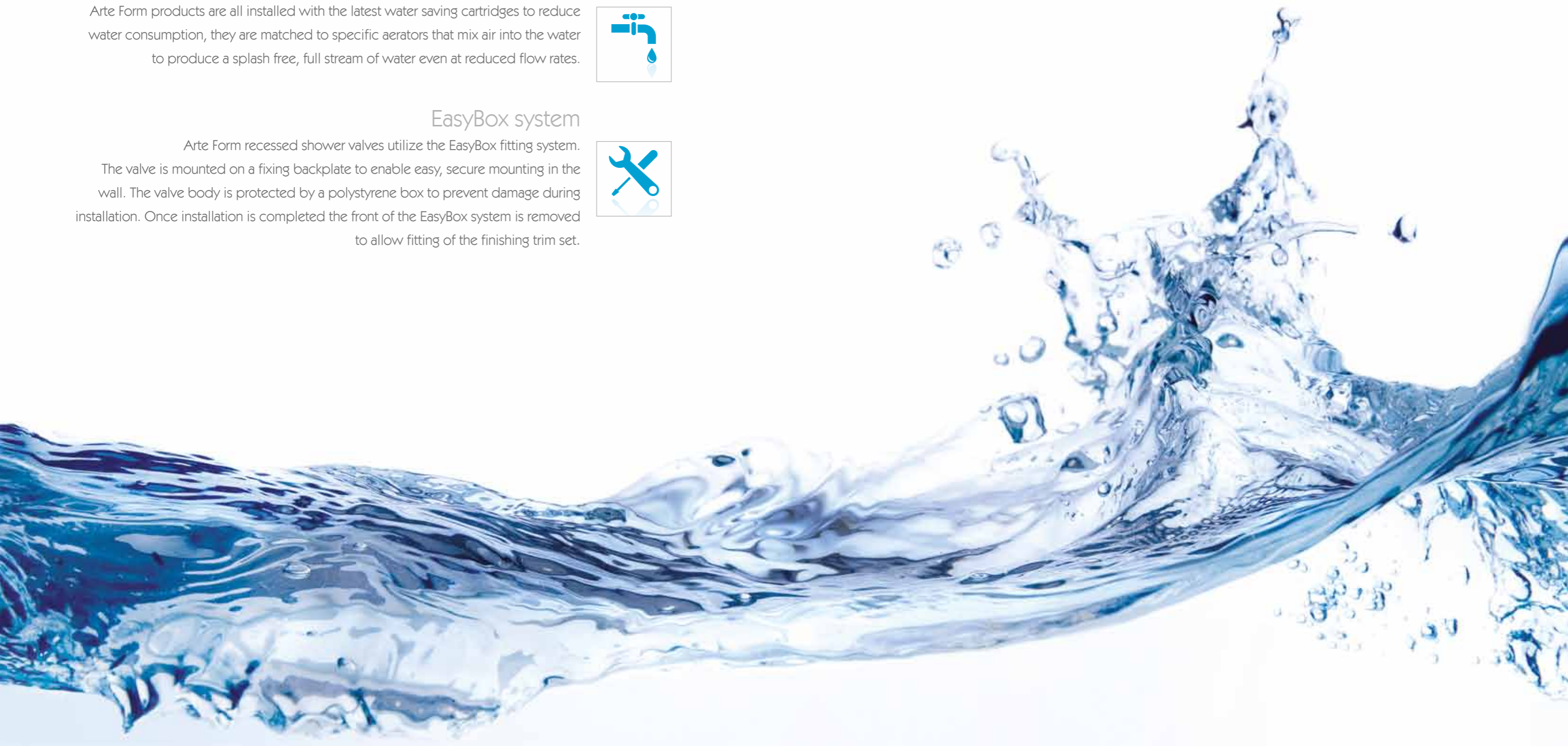

contents

ITAP 18		TIME OUT 70		IKO 104		SHOWERING 138	
FLOW 24		BIRO 76		VIK 108		KITS 140	
TOOX 32		BIRO BRUSHED 80		ARTE FORM INDIVIDUAL 112		FIXED HEADS & ARMS 144	
S22 40		XERO 82		PHILO 116		SKYFALL 154	
PALMA 46		XERO BRUSHED 86		HITO 51 122		SPA 162	
ON OFF 50		MINIME 88		RAJIA 128		ACCESSORIES 166	
NANOTECH 56		MINIME BRUSHED 94		ARCHE & ARCHE CASCATA 132		WASTES 172	
TIME 64		VELA 98					



itap

Designed by Studio P — Porto

A modern design classic re-imagined for your bathroom

waterrevolution



ITAP



BASIN MONO MIXER
IT.121CDN
without waste 0.5 bar MP
H: 110mm P: 130mm
£245



BASIN TALL MONO MIXER
IT.141CDN
without waste 0.5 bar MP
H: 230mm P: 163mm
£315



BASIN 2 HOLE DECK MIXER
IT.122CDN
without waste 0.5 bar MP
H: 90mm P: 130mm
£265



BASIN 3 HOLE DECK MIXER
IT.123CDN
without waste 0.5 bar MP
H: 90mm P: 130mm
£275



BASIN 2 HOLE WALL MIXER
IT.122CWN
without waste 0.5 bar MP
P: 235mm
£315



BASIN 2 HOLE WALL MIXER
IT.122CWN-BP
without waste 0.5 bar MP
P: 235mm
£325

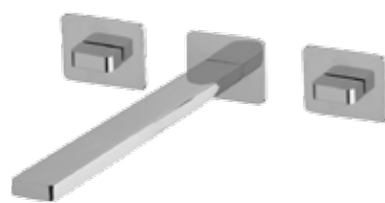

BASIN 3 HOLE WALL MIXER
IT.123CWN
without waste 0.5 bar MP
P: 235mm
£325



BASIN SPOUT 150
IT.151CW-150
0.5 bar MP
P: 150mm
£125



BASIN SPOUT 190
IT.151CW-190
0.5 bar MP
P: 190mm
£145

ITAP



BASIN WALL MIXER
IT.121CWN
without spout 0.5 bar MP
£195



BIDET MONO MIXER
IT.221CDC
without waste 0.5 bar MP
H: 110mm P: 130mm
£235



BATH WALL SPOUT 170
IT.151CW-170
0.5 bar MP
P: 170mm
£125

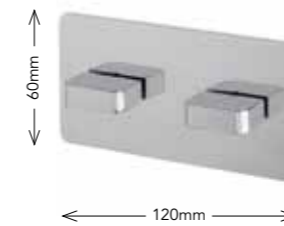

MANUAL SHOWER VALVE
IT.422CR-1
Recessed 1 outlet
1 bar HP
£195

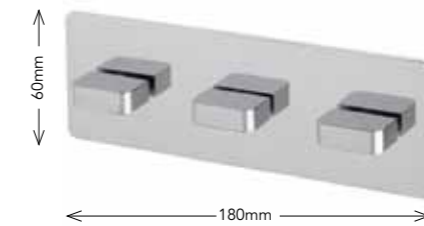

MANUAL VALVE WITH DIVERTER
IT.423CR-2
Recessed 2 outlet
1 bar HP
£275

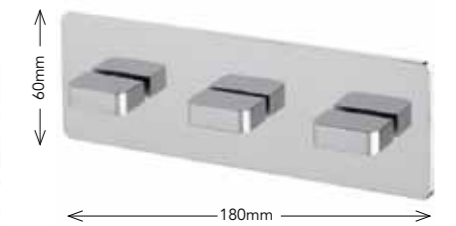

MANUAL VALVE WITH DIVERTER
IT.423CR-3
Recessed 3 outlet
1 bar HP
£325



THERMO SHOWER VALVE
IT.522CR-1
Recessed 1 outlet
1 bar HP
£395

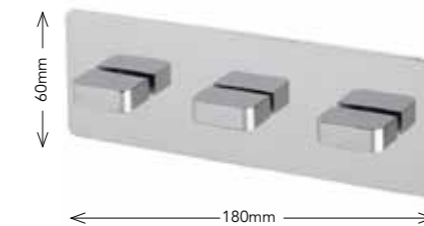

THERMO VALVE WITH DIVERTER
IT.523CR-2
Recessed 2 outlet
1 bar HP
£495

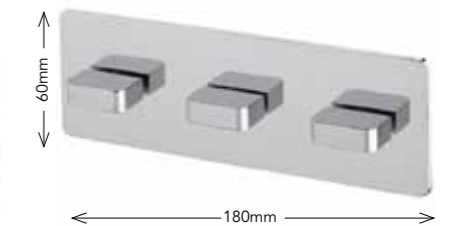

THERMO VALVE WITH DIVERTER
IT.523CR-3
Recessed 3 outlet
3 bar HP
£595

ITAP



WALL PANEL VALVE

IT.321CW-C (COLD)
IT.321CW-H (HOT)
1 bar HP
£95 ea.



DIVERTER 2 OUTLET

IT.321CW-2
Recessed wall mounted
1 bar HP
£165



DIVERTER 3 OUTLET

IT.321CW-3
Recessed wall mounted
1 bar HP
£195



HOSE HANDSET & WALL OUTLET

SH.621C
0.5 bar MP
£195



HOSE HANDSET & WALL BRACKET

SH.622C
0.5 bar MP
£195



SHOWER HEAD WALL MOUNTED

SH.231C-500
P: 500mm W: 100mm
2 bar HP
£495



SHOWER HEAD WALL MOUNTED

SH.232C-500
P: 500mm W: 200mm
2 bar HP
£695

Our showering collection —
from page 138 — has further
outstanding shower designs

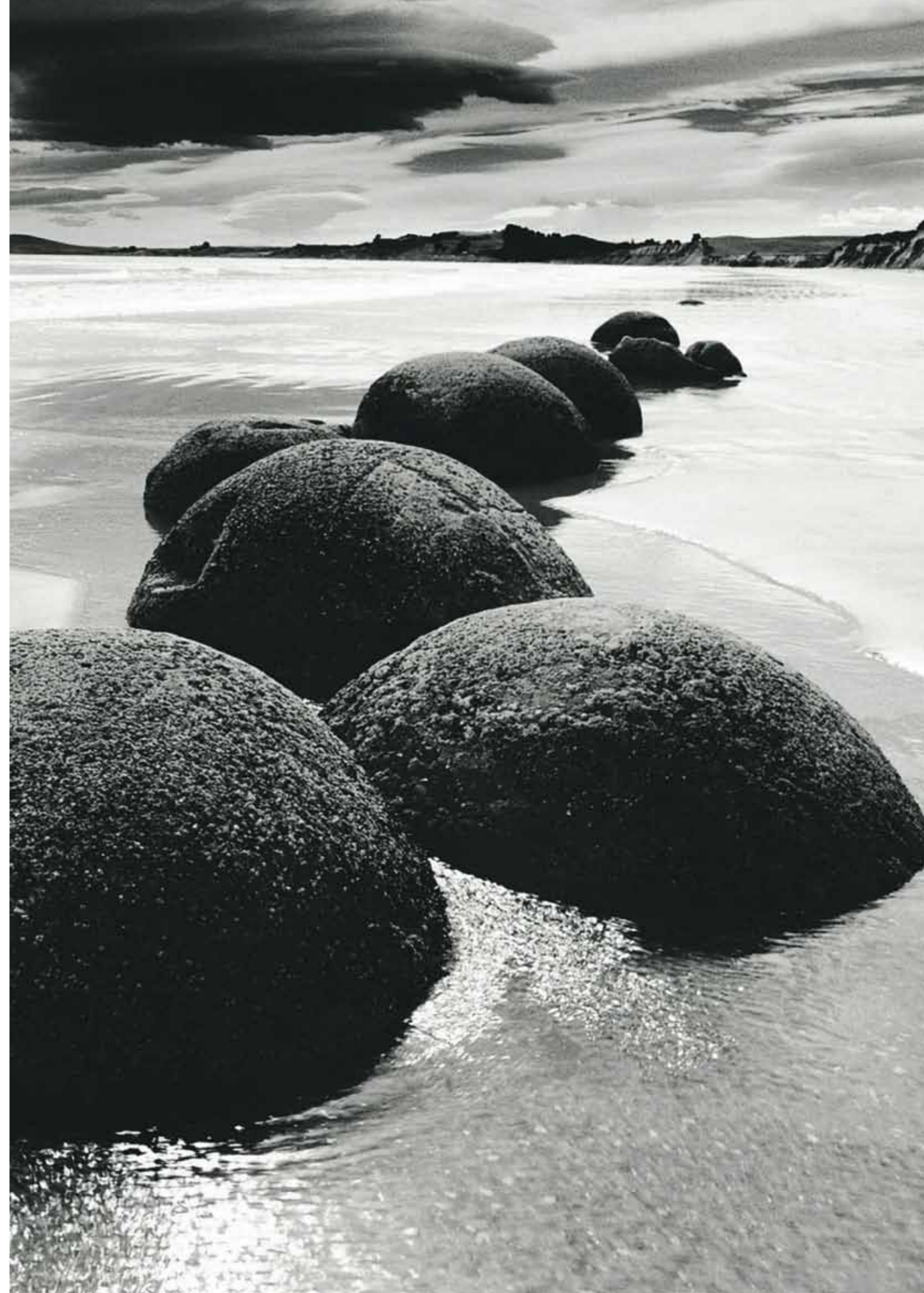



flow

Designed by Studio P — Porto

A design classic combining form and function

 water evolution



FLOW



BASIN MONO MIXER
FL.121CDN
without waste 0.2 bar LP
H: 146mm P: 110mm
£170



BASIN TALL MONO MIXER
FL.141CDN
without waste 0.2 bar LP
H: 285mm P: 178mm
£215



BASIN 2 HOLE DECK MIXER
FL.122CDN-R
without waste 0.5 bar MP
H: 200mm P: 234mm
£225



BASIN 2 HOLE DECK MIXER
FL.122CDN-S
without waste 0.5 bar MP
H: 193mm P: 200mm
£225



BASIN 3 HOLE DECK MIXER
FL.123CDN-S
without waste 0.5 bar MP
H: 193mm P: 200mm
£245



BASIN 2 HOLE EASYBOX WALL MIXER
FL.122CWN
without waste 0.5 bar MP
P: 252mm
£225



BASIN 2 HOLE EASYBOX WALL MIXER
FL.122CWN-BP
without waste 0.2 bar LP
P: 252mm
£265



BASIN 3 HOLE WALL MIXER
FL.123CWN
without waste 0.5 bar MP
P: 252mm
£295



BASIN 3 HOLE WALL MIXER
FL.123CWN-BP
without waste 0.5 bar MP
P: 252mm
£305

FLOW



BASIN WALL SPOUT
FL.151CW-250
0.5 bar MP
P: 252mm
£95



BASIN MONO WALL MIXER
FL.121CWN
without spout 0.5 bar MP
P: 64mm
£165



BIDET MONO MIXER
FL.221CDN
without waste 0.5 bar MP
H: 146mm P: 110mm
£170



BASIN MONO FLOOR STANDING MIXER
FL.141CFN
without waste 1 bar HP
H: 1135mm P: 250mm
£525



BASIN FLOOR STANDING SPOUT
FL.151CF-S
1 bar HP
H: 1085mm P: 200mm
£225

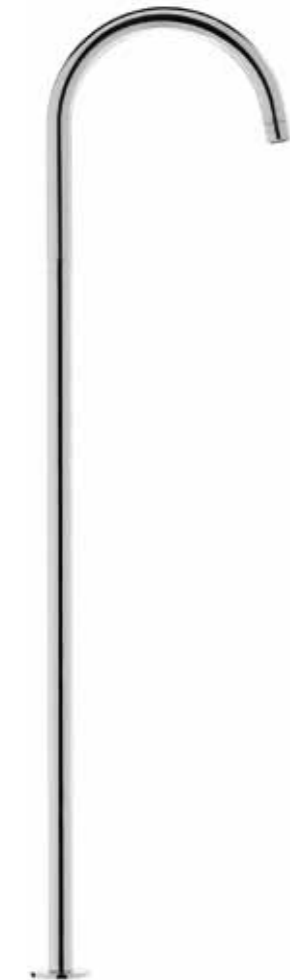

BASIN FLOOR STANDING SPOUT
FL.151CF-R
1 bar HP
H: 1132mm P: 206mm
£225

FLOW



MANUAL BATH SHOWER MIXER

FL.322CE-2
Exposed with shower kit
P: 168mm 1 bar HP
£225



THERMO BATH SHOWER MIXER

FL.322CE-2T
Exposed with shower kit
P: 168mm 1 bar HP
£395



BATH WALL SPOUT

FL.351CW-150
0.2 bar LP
P: 150mm
£95



BATH MONO FLOOR STANDING MIXER

FL.341CF-2
1 bar HP
H: 885mm P: 250mm
£695



BATH MONO FLOOR STANDING FILLER

FL.341CF
1 bar HP
H: 885mm P: 250mm
£495



BATH 4 HOLE DECK MIXER

FL.324CD-S
including shower kit
1 bar HP
£595



BATH 4 HOLE DECK MIXER

FL.324CD-R
including shower kit
1 bar HP
£595



FLOW



MANUAL EASYBOX SHOWER VALVE

FL.411CR-1
Recessed 1 outlet
1 bar HP
£155



MANUAL EASYBOX VALVE WITH DIVERTER

FL.422CR-2
Recessed 2 outlet
1 bar HP
£195



MANUAL EASYBOX VALVE WITH DIVERTER

FL.422CR-3
Recessed 3 outlet
1 bar HP
£275



THERMO EASYBOX SHOWER VALVE

FL.511CR-1
Recessed 1 outlet
1 bar HP
£295



THERMO EASYBOX VALVE WITH DIVERTER

FL.522CR-2
Recessed 2 outlet
1 bar HP
£395



THERMO EASYBOX VALVE WITH DIVERTER

FL.522CR-3
Recessed 3 outlet
3 bar HP
£495

FLOW



WALL PANEL VALVE

FL.321CW-C (COLD)
FL.321CW-H (HOT)
1 bar HP
£95 ea.



DIVERTER 2 OUTLET

FL.321CW-2
Recessed wall mounted
1 bar HP
£145



DIVERTER 3 OUTLET

FL.321CW-3
Recessed wall mounted
1 bar HP
£165

EASYBOX SYSTEM

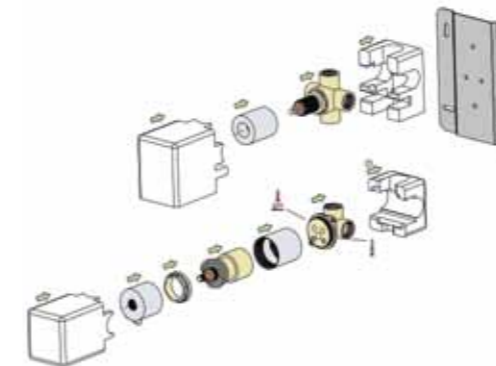

The shower valve is assembled and factory fitted onto a backplate which allows simple secure fixing to the wall.

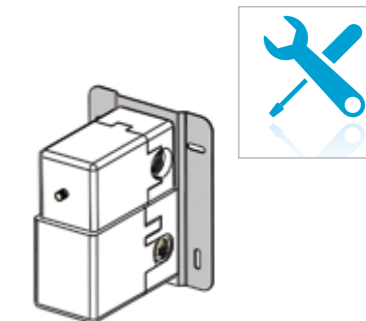
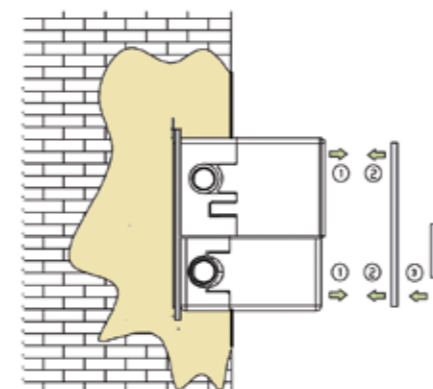

The valve is enclosed in a polystyrene box to prevent damage during installation.

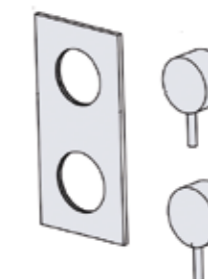

Once the valve has been fully installed and the wall made good and tiled the top half of the polystyrene box is removed and the finishing trim set is fitted.



toox

Designed by Stefano Macchion — GEDA

TOOX is created around the elegance of pure shapes.
Milled from high grade stainless steel, TOOX is the essence of design.



TOOX



BASIN MONO MIXER
TX.121SDN
without waste 0.5 bar MP
H: 168mm P: 131mm
£325



BASIN MID MONO MIXER
TX.131SDN
without waste 0.5 bar MP
H: 208mm P: 175mm
£345



BASIN TALL MONO MIXER
TX.141SDN
without waste 0.5 bar MP
H: 338mm P: 175mm
£375



BASIN MONO DECK MIXER
TX.111SDN
without waste no spout
0.5 bar MP
£295



BASIN MONO WALL MIXER
TX.111SWN
without waste no spout
0.5 bar MP
£275



BASIN DECK SWIVEL SPOUT
TX.151SD
0.5 bar MP
H: 230mm P: 128mm
£245



BASIN WALL SPOUT
TX.151SW-190
0.5 bar MP
P: 190mm
£175



BASIN WALL SPOUT
TX.151SW-250
0.5 bar MP
P: 250mm
£195



BIDET MONO MIXER
TX.221SDN
without waste 0.5 bar MP
H: 168mm P: 112mm
£325

TOOX



BASIN FLOOR MONO MIXER
TX.141SDN
without waste 0.5 bar MP
H: 1135mm P: 220mm
£725



BASIN FLOOR SPOUT
TX.151SF
without waste 0.5 bar MP
H: 1190mm P: 240mm
£595



BATH 3 HOLE DECK MIXER

TX.323SD-2
including shower kit
1 bar HP
£795



BATH 4 HOLE DECK MIXER

TX.324SD-2
including shower kit
1 bar HP
£995



BATH 3 HOLE WALL MIXER

TX.323SW-2
including shower kit
1 bar HP
£795



BATH 4 HOLE WALL MIXER

TX.324SW-2
including shower kit
1 bar HP
£995

TOOX



BATH MONO FLOOR STANDING MIXER
TX.341SF-2
1 bar HP
H: 1200mm P: 400mm
£1995



BATH WALL SPOUT
TX.351SW-180
0.5 bar MP
P: 180mm
£235



DIVERTER 2 OUTLET
TX.321SW-2
Recessed wall mounted
1 bar HP
£295



DIVERTER 3 OUTLET
TX.321SW-3
Recessed wall mounted
1 bar HP
£395



s22

Designed by world renowned architect Eduardo Souto De Moura

Winner of architecture's biggest prize, The Pritzker, in 2011

Manufactured in high grade stainless steel





BASIN MONO MIXER
S22.121SDN
without waste 1 bar HP
H: 139mm P: 130mm
£295



BASIN TALL MONO MIXER
S22.141SDN
without waste 1 bar HP
H: 277mm P: 210mm
£365



BIDET MONO MIXER
S22.221SDN
without waste 1 bar HP
H: 135mm P: 130mm
£295



BASIN 2 HOLE WALL MIXER
S22.122SWN
without waste 1 bar HP
P: 240mm
£385



BASIN 3 HOLE WALL MIXER
S22.123SWN-BP
without waste 1 bar HP
P: 240mm
£395



MANUAL BATH SHOWER MIXER
S22.322SE-2
Exposed with shower kit
P: 155mm 1 bar HP
£395



THERMO BATH SHOWER MIXER
S22.322SE-2T
Exposed with shower kit
P: 155mm 1 bar HP
£595



BATH WALL SPOUT
S22.351SW-160
1 bar HP
P: 162mm
£155



**S22 HOSE HANDSET & WALL
OUTLET**
SH.611S
0.5 bar MP
£225

Matching range of stainless steel
accessories available see page 166

INOX

Arte Form use Marine Grade SAE 316 and 304 stainless steel in the production of taps, showerheads and accessories. Stainless steel is hygienic, hard wearing, easy to clean and is environmentally friendly in its production process.



WALL PANEL VALVE
S22.321SW-C (COLD) **£155**
S22.321SW-H (HOT) **£155**
1 bar HP



DIVERTER VALVES
S22.321SW-2 2 outlet **£265**
S22.321SW-3 3 outlet **£295**
1 bar HP

S22



MANUAL EASYBOX SHOWER VALVE

S22.411SR-1
Recessed 1 outlet
1 bar HP
£295



MANUAL EASYBOX SHOWER VALVE

S22.422SR-2
Recessed 2 outlet
1 bar HP
£345



MANUAL EASYBOX SHOWER VALVE

S22.422SR-3
Recessed 3 outlet
1 bar HP
£445



THERMO EASYBOX SHOWER VALVE

S22.511SR-1
Recessed 1 outlet
1 bar HP
£445



THERMO EASYBOX SHOWER VALVE

S22.522SR-2
Recessed 2 outlet
1 bar HP
£495



THERMO EASYBOX SHOWER VALVE

S22.522SR-3
Recessed 3 outlet
1 bar HP
£595

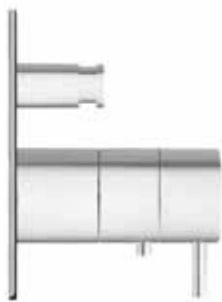
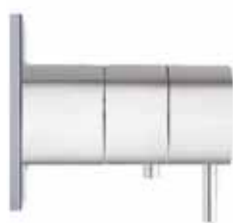

IRON RUSTS AND CHANGES, WOOD IS EASILY DAMAGED AND AGES, CEMENT STAINS AND TARNISHES, STEEL DOES NOT.

STEEL IS ECO-COMPATIBLE, STEEL DOES NOT DETERIORATE, STEEL IS HYGENIC, STEEL LASTS FOREVER...





palma

Designed by award-winning
Spanish architect Francisco Mangado

Sharp angles and soft curves combine in this futuristic design

 water evolution



PALMA



BASIN MONO MIXER
PA.121CDN
without waste 0.5 bar MP
H: 110mm P: 120mm
£245



BASIN TALL MONO MIXER
PA.141CDN
without waste 0.5 bar MP
H: 252mm P: 120mm
£295



BASIN 2 HOLE WALL MIXER
PA.122CWN
without waste 0.5 bar MP
P: 165mm
£345



BIDET MONO MIXER
PA.221CDN
without waste 0.5 bar MP
H: 110mm P: 120mm
£245



BATH WALL SPOUT
PA.351CW-170
1 bar HP
P: 170mm
£145



MANUAL BATH SHOWER MIXER
PA.322CE-2
Exposed with shower kit
P: 160mm 1 bar HP
£345



THERMO BATH SHOWER MIXER
PA.322CE-2T
Exposed with shower kit
P: 168mm 1 bar HP
£495

PALMA



MANUAL EASYBOX SHOWER VALVE
PA.411CR-1
Recessed 1 outlet
1 bar HP
£215



MANUAL EASYBOX SHOWER VALVE
PA.422CR-2
Recessed 2 outlet
1 bar HP
£265



MANUAL EASYBOX SHOWER VALVE
PA.422CR-3
Recessed 3 outlet
1 bar HP
£365



THERMO EASYBOX SHOWER VALVE
PA.511CR-1
Recessed 1 outlet
1 bar HP
£365



THERMO EASYBOX VALVE WITH DIVERTER
PA.522CR-2
Recessed 2 outlet
1 bar HP
£425



THERMO EASYBOX VALVE WITH DIVERTER
PA.522CR-3
Recessed 3 outlet
3 bar HP
£525





on off

Designed by Studio P — Porto

Clean circular lines and effortless simplicity

 waterrevolution



ON OFF



BASIN MONO MIXER
ON.121CDN
without waste 0.5 bar MP
H: 105mm P: 75mm
£225



BASIN 2 HOLE DECK MIXER
ON.122CDN
without waste 0.5 bar MP
H: 105mm P: 117mm
£265



BASIN 3 HOLE DECK MIXER
ON.123CDN
without waste 0.5 bar MP
H: 105mm P: 110mm
£285



BASIN 2 HOLE WALL MIXER
ON.122CWN
without waste 0.5 bar MP
P: 215mm
£285



BASIN 2 HOLE WALL MIXER
ON.122CWN-BP
without waste 0.5 bar MP
P: 215mm
£285

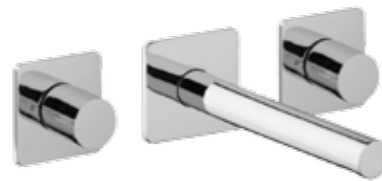

BASIN 3 HOLE WALL MIXER
ON.123CWN
without waste 0.5 bar MP
P: 215mm
£295



BIDET MONO MIXER
ON.221CDN
without waste 0.5 bar MP
H: 105mm P: 110mm
£225



BATH WALL SPOUT
ON.351CW-170
0.5 bar MP
P: 170mm
£125

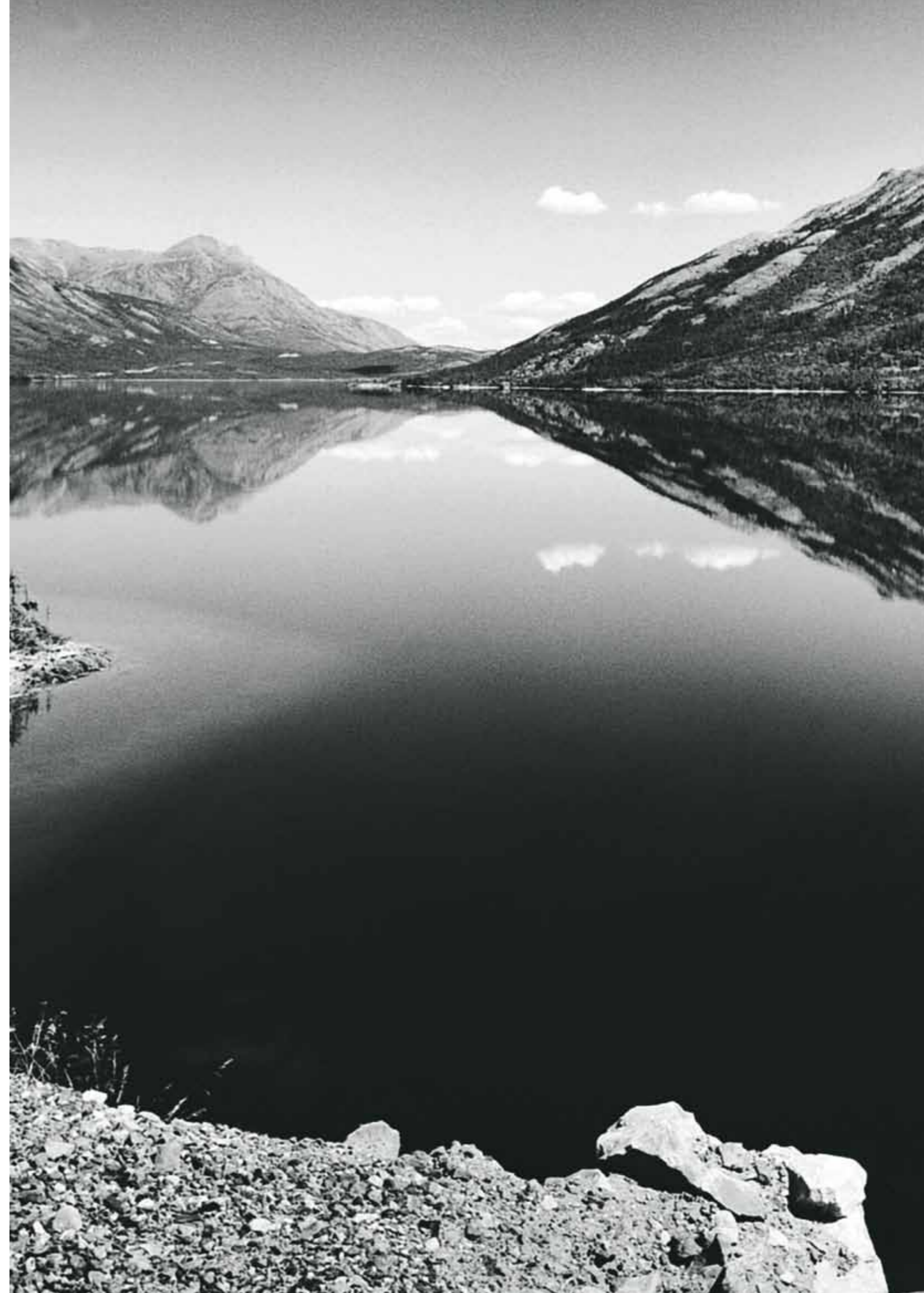

ON OFF



MANUAL SHOWER VALVE
ON.422CR-1
Recessed 1 outlet
1 bar HP
£195



MANUAL VALVE WITH DIVERTER
ON.423CR-2
Recessed 2 outlet
1 bar HP
£275



MANUAL VALVE WITH DIVERTER
ON.423CR-3
Recessed 3 outlet
1 bar HP
£325



THERMO SHOWER VALVE
ON.522CR-1
Recessed 1 outlet
1 bar HP
£395



THERMO VALVE WITH DIVERTER
ON.523CR-2
Recessed 2 outlet
1 bar HP
£495



THERMO VALVE WITH DIVERTER
ON.523CR-3
Recessed 3 outlet
1 bar HP
£595

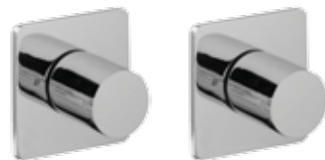

WALL PANEL VALVE
ON.321CW-C (COLD)
ON.321CW-H (HOT)
1 bar HP
£95 ea.



DIVERTER 2 OUTLET
ON.321CW-2
Recessed wall mounted
1 bar HP
£165



DIVERTER 3 OUTLET
ON.321CW-3
Recessed wall mounted
1 bar HP
£195

ON OFF



ON OFF HOSE HANDSET & WALL OUTLET
SH.612C
0.5 bar MP
£155



ON OFF WALL MOUNT SHOWER HEAD
SH.243C-30
1 bar HP
W: 30mm P: 60mm
£175



ON OFF WALL MOUNT SHOWER HEAD
SH.241C-155
2 bar HP
W: 155mm P: 155mm
£445

“Thermo valves are perfect for your little heroes”





nanotech

Designed by Gianluca Belli – PHI CUBO

Technological innovation and water-saving
are the concepts behind Nanotech

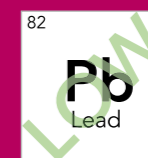

NANOTECH



BASIN MINI MONO MIXER

NT.111CDN
without waste 0.2 barLP
H: 107mm P: 85mm
£145



BASIN MONO MIXER

NT.121CDN
without waste 0.2 barLP
H: 140mm P: 90mm
£185



BASIN TALL MONO MIXER

NT.141CDN
without waste 0.2 barLP
H: 305mm P: 120mm
£285



BASIN MONO FLOOR STANDING MIXER

NT.141CFN
without waste 1 bar HP
H: 993mm P: 120mm
£695



BASIN 2 HOLE WALL MIXER

NT.122CWN
without waste 0.5 bar MP
P: 165mm
£385



BASIN 2 HOLE WALL MIXER

NT.122CWN-BP
without waste 0.5 bar MP
P: 165mm
£365

An ultra modern design with simple and harmonious shapes are the ideas behind Nanotech.

Visit www.arteform.co.uk to see this tap in action...



NANOTECH



BATH MONO FLOOR STANDING MIXER

NT.341CF-2
1 bar HP
H: 793mm P: 180mm OD: 275mm
£1195

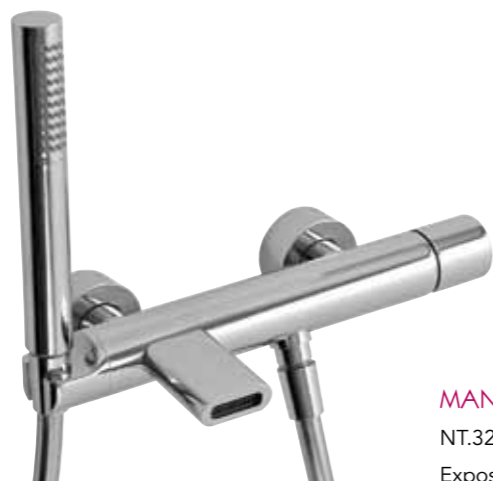

MANUAL BATH SHOWER MIXER

NT.322CE-2
Exposed with shower kit
P: 145mm 1 bar HP
£575



DOUCHE KIT

NT.221CW
0.5 bar MP

£225



HOSE HANDSET & WALL OUTLET

SH.626C
1 bar HP
£425



NANOTECH



MANUAL SHOWER VALVE

NT.422CR-1
Recessed 1 outlet
1 bar HP
£195



MANUAL VALVE WITH DIVERTER

NT.423CR-2
Recessed 2 outlet
1 bar HP
£275



MANUAL VALVE WITH DIVERTER

NT.423CR-3
Recessed 3 outlet
1 bar HP
£325



THERMO SHOWER VALVE

NT.522CR-1
Recessed 1 outlet
1 bar HP
£395



THERMO VALVE WITH DIVERTER

NT.523CR-2
Recessed 2 outlet
1 bar HP
£495



THERMO VALVE WITH DIVERTER

NT.523CR-3
Recessed 3 outlet
1 bar HP
£595



WALL PANEL VALVE

NT.321CW-C (COLD)
NT.321CW-H (HOT)
1 bar HP
£95 ea.



DIVERTER 2 OUTLET

NT.321CW-2
Recessed wall mounted
1 bar HP
£165



DIVERTER 3 OUTLET

NT.321CW-3
Recessed wall mounted
1 bar HP
£195



See page 112 for Arte Form Individual



time

Designed by Marco Pisati — Firenze

Renowned Designer Marco Pisati brings Italian style to your bathroom with his TIME & TIME OUT designs

RUBINETTERIE
treemme

82
Pb
Lead



TIME



BASIN MONO MIXER
TM.121CDN
without waste 0.5 bar MP
H: 162mm P: 130mm
£275



BASIN TALL MONO MIXER
TM.141CDN
without waste 0.5 bar MP
H: 228mm P: 130mm
£375



BASIN 2 HOLE WALL MIXER
TM.122CWN
without waste 0.5 bar MP
P: 190mm
£395



BASIN 2 HOLE WALL MIXER
TM.142CWN
without waste 0.5 bar MP
P: 260mm
£425



BASIN 2 HOLE WALL MIXER
TM.122CWN-BP
without waste 0.5 bar MP
P: 190mm
£375



BASIN 2 HOLE WALL MIXER
TM.142CWN-BP
without waste 0.5 bar MP
P: 260mm
£395



BIDET MONO MIXER
TM.221CDN
with waste 0.5 bar MP
H: 155mm P: 130mm
£285



BATH WALL SPOUT
TM.351CW-210
1 bar MP
P: 210mm
£175

Time is available in a choice of finishes. See Arte Form individual on page 112 or visit www.arteform.co.uk for more information.



TIME



MANUAL SHOWER VALVE
TM.421CR-1
Recessed 1 outlet
1 bar HP
£225



MANUAL VALVE WITH DIVERTER
TM.422CR-2
Recessed 2 outlet
1 bar HP
£305



BATH 4 HOLE WALL MIXER
TM.324CW-2
including shower kit
P: 202mm 1 bar HP
£995



SHOWER ARM
TM.231C-360
P: 360mm 1 bar HP
£295



SHOWER ARM
TM.231C-420
P: 420mm 1 bar HP
£345



SHOWER ARM
TM.231C-480
P: 480mm 1 bar HP
£375



MANIFOLD 3 WAY
TM.433M
£100



MANIFOLD 6 WAY
TM.436M
£150

Select between
one and six arms
in three different
lengths for your own
unique showering
experience...

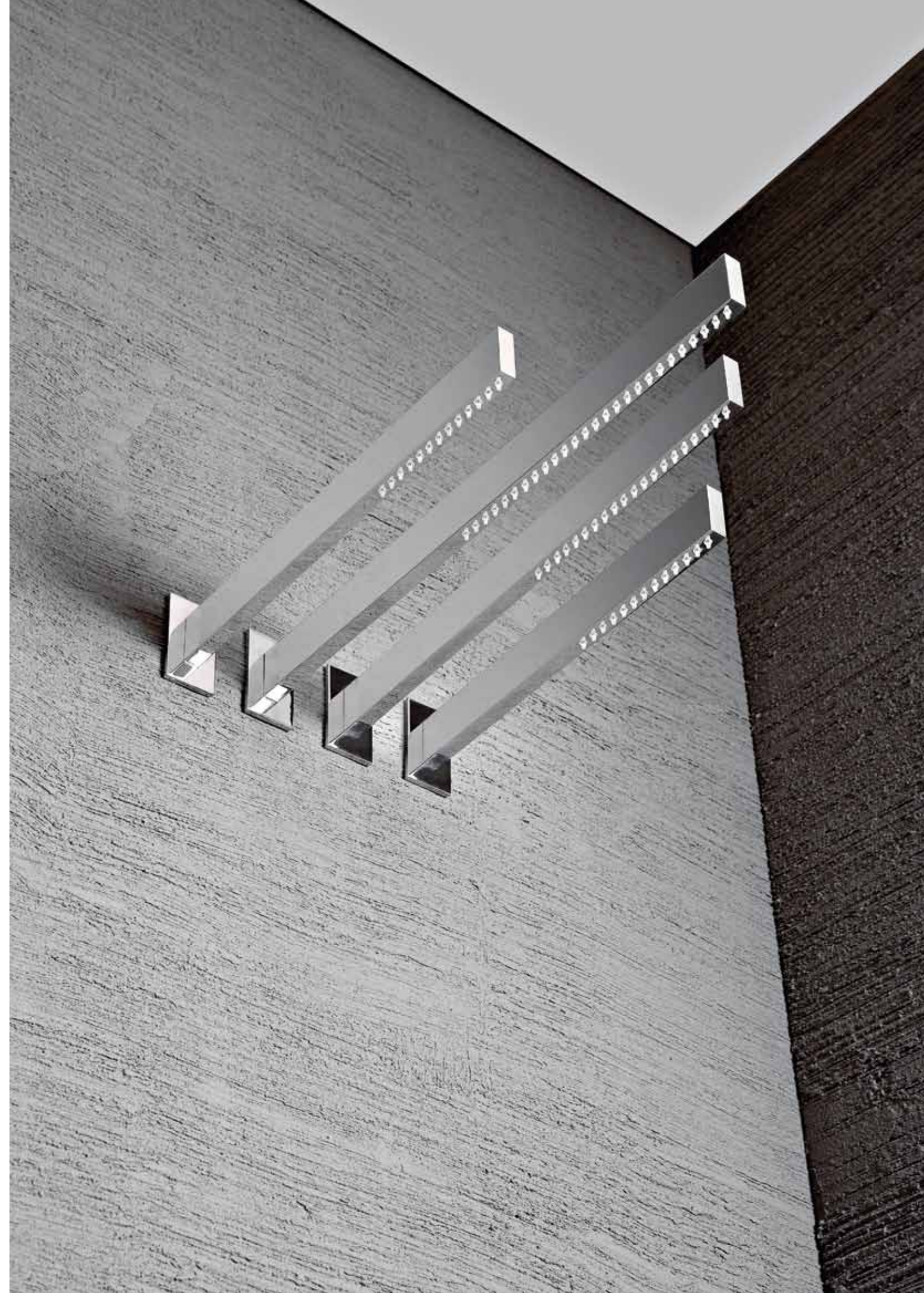



time out

Designed by Marco Pisati — Firenze

Renowned Designer Marco Pisati brings Italian style to your bathroom with his TIME & TIME OUT designs

RUBINETTERIE
treemme

82
Pb
Lead



TIME OUT



BASIN MONO MIXER
TO.121CDN
without waste 0.5 bar MP
H: 162mm P: 130mm
£265



BASIN TALL MONO MIXER
TO.141CDN
without waste 0.5 bar MP
H: 228mm P: 130mm
£365



BASIN 2 HOLE WALL MIXER
TO.122CWN
without waste 0.5 bar MP
P: 190mm
£375



BATH WALL SPOUT
TM.351CW-210
1 bar MP
P: 210mm
£175



BATH 4 HOLE WALL MIXER
TO.324CW-2
including shower kit
P: 202mm 1 bar HP
£975



BASIN 2 HOLE WALL MIXER
TO.142CWN
without waste 0.5 bar MP
P: 260mm
£395



BASIN 2 HOLE WALL MIXER
TO.122CWN-BP
without waste 0.5 bar MP
P: 190mm
£345



BASIN 2 HOLE WALL MIXER
TO.142CWN-BP
without waste 0.5 bar MP
P: 260mm
£375



SHOWER ARM
TM.231C-360
P: 360mm 1 bar HP
£295



SHOWER ARM
TM.231C-420
P: 420mm 1 bar HP
£345



SHOWER ARM
TM.231C-480
P: 480mm 1 bar HP
£375



BIDET MONO MIXER
TO.221CDN
with waste 0.5 bar MP
H: 155mm P: 130mm
£275



MANUAL SHOWER VALVE
TO.421CR-1
Recessed 1 outlet
1 bar HP
£225



MANUAL VALVE WITH DIVERTER
TO.422CR-2
Recessed 2 outlet
1 bar HP
£295



MANIFOLD 3 WAY
TM.433M
£100



MANIFOLD 6 WAY
TM.436M
£150

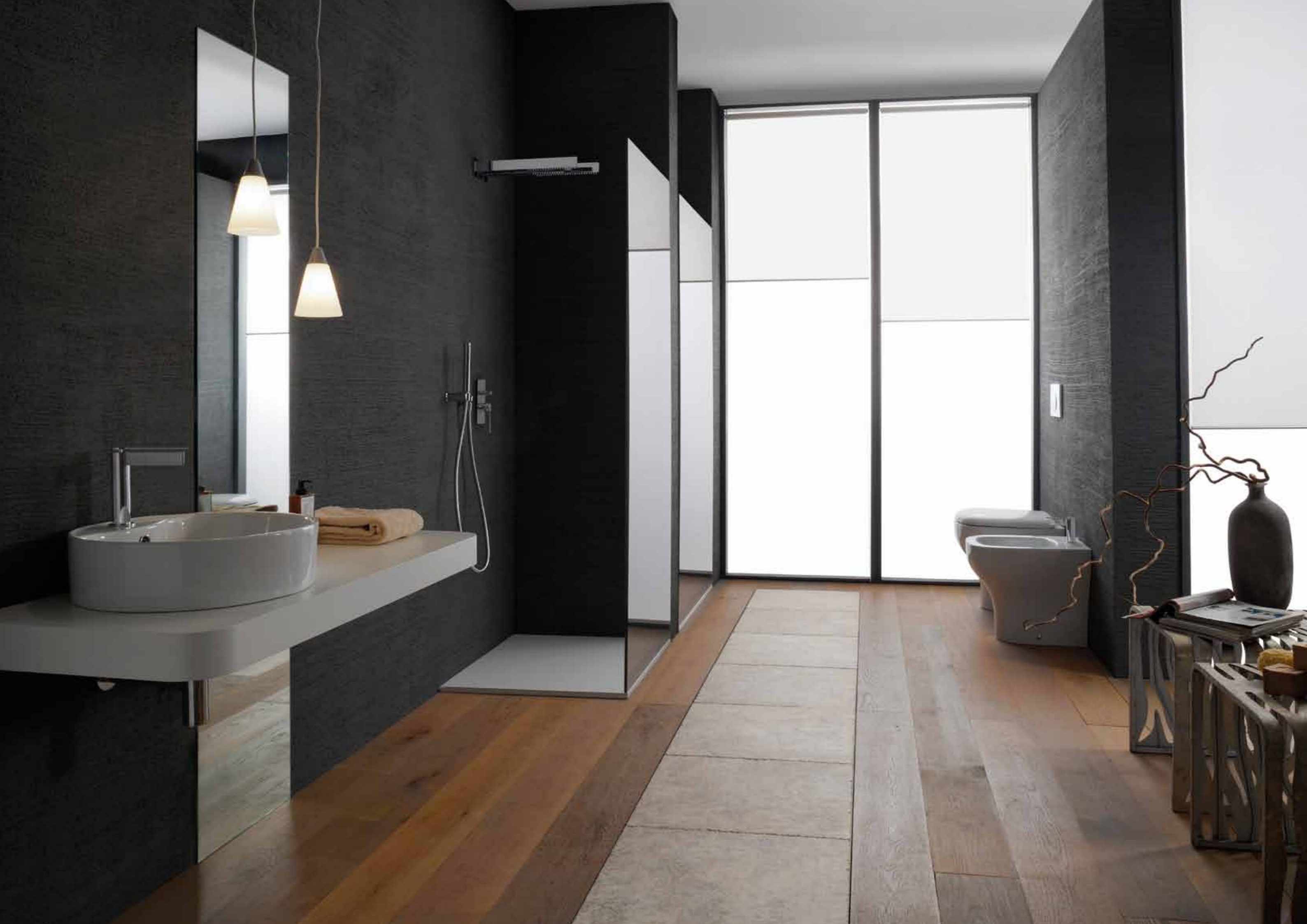



biro

Designed by Stefano Macchion — GEDA

Contemporary angular design



BIRO



BASIN MONO MIXER
BR.121CDN
without waste 0.5 bar MP
H: 166mm P: 146mm
£195



BASIN MID MONO MIXER
BR.131CDN
without waste 0.5 bar MP
H: 206mm P: 164mm
£245



BASIN TALL MONO MIXER
BR.141CDN
without waste 0.5 bar MP
H: 336mm P: 190mm
£295



BASIN 2 HOLE WALL MIXER
BR.122CWN
without waste 0.5 bar MP
P: 190mm
£345



BIDET MONO MIXER
BR.221CDN
without waste 0.5 bar MP
H: 166mm P: 120mm
£225



BASIN MONO FLOOR STANDING MIXER
BR.141CFN
without waste 1 bar HP
H: 1100mm P: 220mm
£795

BIRO



MANUAL BATH SHOWER MIXER
BR.322CE-2
Exposed with shower kit
P: 179mm 1 bar HP
£395



BATH 3 HOLE DECK MIXER
BR.323CD-2
including shower kit
1 bar HP
£595

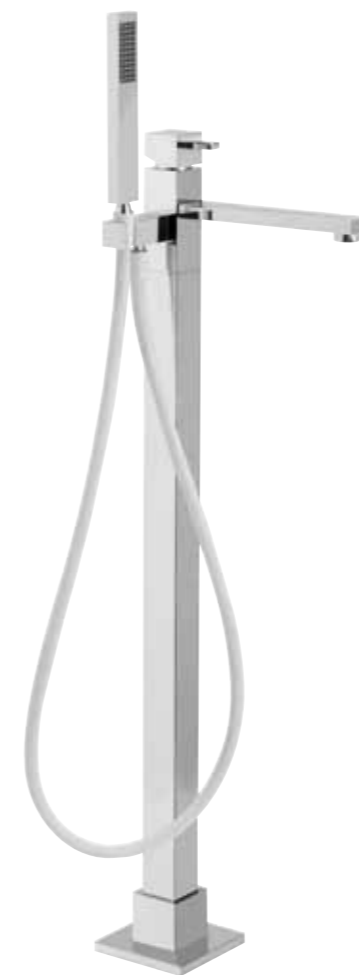

BATH MONO FLOOR STANDING MIXER
BR.341CF-2
1 bar HP
H: 885mm P: 250mm
£1695



MANUAL SHOWER VALVE
BR.421CR-1
Recessed 1 outlet
1 bar HP
£195



MANUAL VALVE WITH DIVERTER
BR.422CR-2
Recessed 2 outlet
1 bar HP
£295



MANUAL VALVE WITH DIVERTER AND OUTLET
BR.423CR-2
Recessed 2 outlet
1 bar HP
£395



Full range of matching accessories available, see page 166

BIRO BRUSHED



BASIN MONO MIXER
BR.121BDN
without waste 0.5 bar MP
H: 166mm P: 146mm
£275



BASIN MID MONO MIXER
BR.131BDN
without waste 0.5 bar MP
H: 206mm P: 164mm
£325



BASIN TALL MONO MIXER
BR.141BDN
without waste 0.5 bar MP
H: 336mm P: 190mm
£365



BASIN 2 HOLE WALL MIXER
BR.122BWN
without waste 0.5 bar MP
P: 190mm
£395



BIDET MONO MIXER
BR.221BDN
without waste 0.5 bar MP
H: 166mm P: 120mm
£295



BASIN MONO FLOOR STANDING MIXER
BR.141BFN
without waste 1 bar HP
H: 1100mm P: 220mm
£895

BIRO BRUSHED



MANUAL BATH SHOWER MIXER
BR.322BE-2
Exposed with shower kit
P: 179mm 1 bar HP
£445



BATH 3 HOLE DECK MIXER
BR.323BD-2
including shower kit
1 bar HP
£795



BATH MONO FLOOR STANDING MIXER
BR.341BF-2
1 bar HP
H: 905mm P: 225mm
£1995



MANUAL SHOWER VALVE
BR.422BR-1
Recessed 1 outlet
1 bar HP
£275



MANUAL VALVE WITH DIVERTER
BR.422BR-2
Recessed 2 outlet
1 bar HP
£325



MANUAL VALVE WITH DIVERTER AND OUTLET
BR.423BR-2
Recessed 2 outlet
1 bar HP
£495



Full range of matching accessories available, see page 166



xero

Designed by Armando Medina — Sienna

Compact lines and easy design merge into one

treemme
RUBINETTERIE

82

Pb
Lead



XERO



BASIN MONO MIXER
XO.121CDN
without waste 0.5 bar MP
H: 155mm P: 120mm
£195



BASIN TALL MONO MIXER
XO.141CDN
without waste 0.5 bar MP
H: 285mm P: 135mm
£295



BASIN 2 HOLE WALL MIXER
XO.122CWN
without waste 0.5 bar MP
P: 195mm
£365



BASIN 2 HOLE WALL MIXER
XO.142CWN
without waste 0.5 bar MP
P: 254mm
£395



BASIN 2 HOLE WALL MIXER
XO.122CWN-BP
without waste 0.5 bar MP
P: 195mm
£345



BASIN 2 HOLE WALL MIXER
XO.142CWN-BP
without waste 0.5 bar MP
P: 254mm
£375



BIDET MONO MIXER
XO.221CDN
without waste 0.5 bar MP
H: 155mm P: 118mm
£225



MANUAL SHOWER VALVE
XO.421CR-1
Recessed 1 outlet
1 bar HP
£165



MANUAL VALVE WITH DIVERTER
XO.422CR-2
Recessed 2 outlet
1 bar HP
£265

XERO



MANUAL BATH SHOWER MIXER
XO.322CE-2
Exposed with shower kit
P: 205mm 1 bar HP
£575



BATH 3 HOLE DECK MIXER
XO.323CD-2
including shower kit
1 bar HP
£845



THERMO MULTI-FUNCTION SHOWER
XO.522CE-2
Exposed 2 outlet
1 bar HP
£995

XERO BRUSHED



BASIN MONO MIXER
XO.121BDN
without waste 0.5 bar MP
H: 155mm P: 120mm
£265



BASIN TALL MONO MIXER
XO.141CBN
without waste 0.5 bar MP
H: 285mm P: 135mm
£395



BASIN 2 HOLE WALL MIXER
XO.122BWN
without waste 0.5 bar MP
P: 195mm
£545

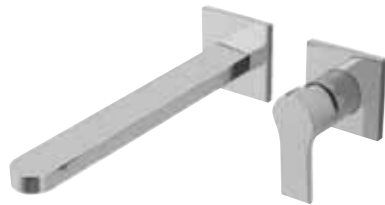

BASIN 2 HOLE WALL MIXER
XO.142BWN
without waste 0.5 bar MP
P: 254mm
£595



BASIN 2 HOLE WALL MIXER
XO.122CBN-BP
without waste 0.5 bar MP
P: 195mm
£465



BASIN 2 HOLE WALL MIXER
XO.142BWN-BP
without waste 0.5 bar MP
P: 254mm
£525



BASIN MONO MIXER
XO.221BDN
without waste 0.5 bar MP
H: 155mm P: 118mm
£295



MANUAL SHOWER VALVE
XO.421BR-1
Recessed 1 outlet
1 bar HP
£225



MANUAL VALVE WITH DIVERTER
XO.422BR-2
Recessed 2 outlet
1 bar HP
£345

XERO BRUSHED



MANUAL BATH SHOWER MIXER
XO.322BE-2
Exposed with shower kit
P: 205mm 1 bar HP
£695



THERMO MULTIFUNCTION SHOWER
XO.522BE-2
Exposed 2 outlet
1 bar HP
£1295



BATH 3 HOLE DECK MIXER
XO.323BD-2
including shower kit
1 bar HP
£1095



minime

Designed by Stefano Macchion — GEDA

Clean smooth lines — the essence of water movement



MINIME



BASIN MONO MIXER
MM.121CDN
without waste 0.5 bar MP
H: 150mm P: 119mm
£185



BASIN TALL MONO MIXER
MM.141CDN
without waste 0.5 bar MP
H: 317mm P: 119mm
£225



BASIN 2 HOLE WALL MIXER
MM.122CWN-BP
without waste 0.5 bar MP
P: 220mm
£375



BASIN MID MONO MIXER - SIDE LEVER
MM.131CDN-S
without waste 0.5 bar MP
H: 276mm P: 111mm
£225



BASIN TALL MONO MIXER - SIDE LEVER
MM.141CDN-S
without waste 0.5 bar MP
H: 396mm P: 141mm
£255



BASIN 2 HOLE DECK MIXER
MM.122CDN
without waste 0.5 bar MP
H: 185mm P: 111mm
£265



BASIN TALL 2 HOLE DECK MIXER
MM.142CDN
without waste 0.5 bar MP
H: 306mm P: 141mm
£295



BASIN FLOOR MONO MIXER
MM.141CFN
without waste 1 bar HP
H: 1176mm P: 141mm
£695

MINIME



BIDET MONO MIXER
MM.221CDN
without waste 0.5 bar MP
H: 150mm P: 115mm
£185



BATH 3 HOLE WALL MIXER
MM.323CW-2
including shower kit
1 bar HP
£495

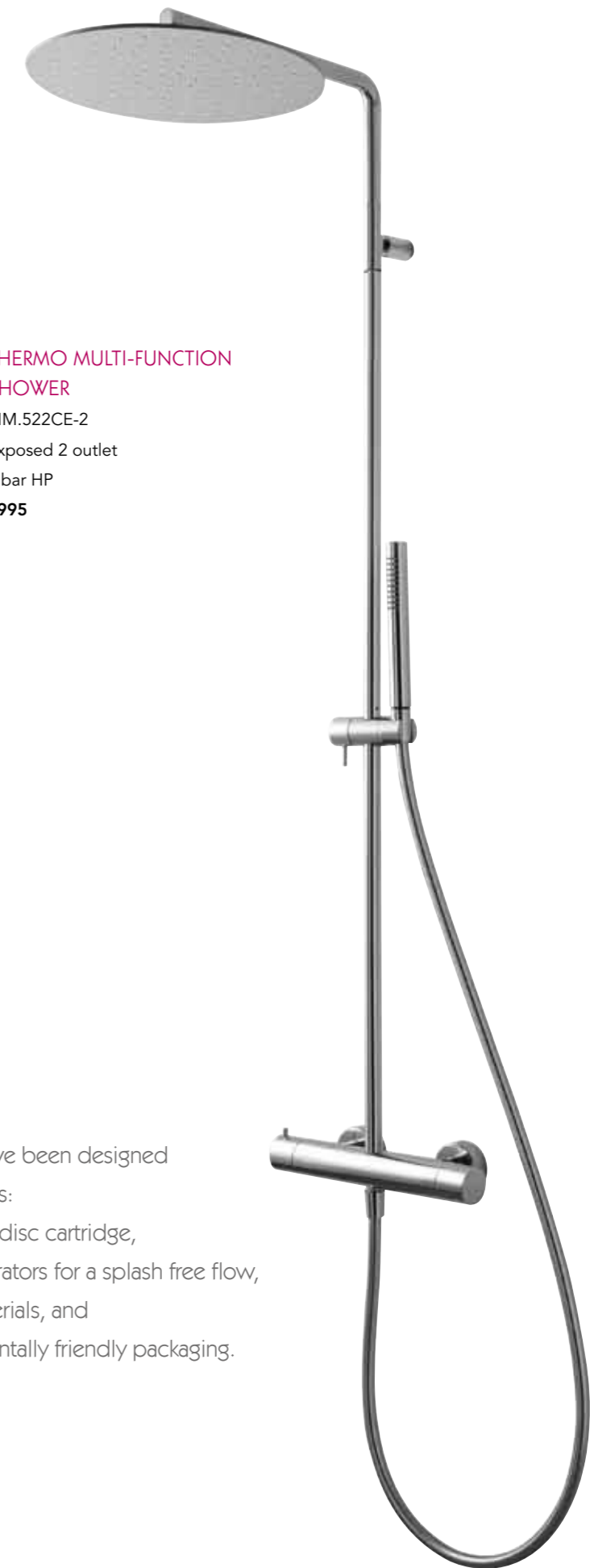

THERMO MULTI-FUNCTION SHOWER
MM.522CE-2
Exposed 2 outlet
1 bar HP
£995



Ranges carrying this logo have been designed with the following principles:

- water saving ceramic disc cartridge,
- use of air injection aerators for a splash free flow,
- easily recyclable materials, and
- recyclable environmentally friendly packaging.

MINIME



MANUAL BATH SHOWER MIXER

MM.322CE-2
Exposed with shower kit
P: 168mm 1 bar HP
£225



THERMO BATH SHOWER MIXER

MM.322CE-2T
Exposed with shower kit
P: 168mm 1 bar HP
£395

MINIME



MANUAL EASYBOX SHOWER VALVE

MM.411CR-1
Recessed 1 outlet
1 bar HP
£155



MANUAL EASYBOX VALVE WITH DIVERTER

MM.422CR-2
Recessed 2 outlet
1 bar HP
£195



MANUAL EASYBOX VALVE WITH DIVERTER

MM.422CR-3
Recessed 3 outlet
1 bar HP
£275



THERMO VALVE

MM.511CR-1
Recessed 1 outlet
1 bar HP
£335



THERMO VALVE WITH DIVERTER

MM.522CR-2
Recessed 2 outlet
1 bar HP
£395



THERMO EASYBOX VALVE WITH DIVERTER

MM.522CR-3
Recessed 3 outlet
3 bar HP
£495



EASYBOX SYSTEM

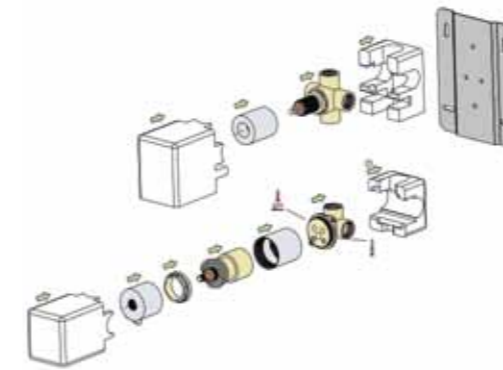

The shower valve is assembled and factory fitted onto a backplate which allows simple secure fixing to the wall.

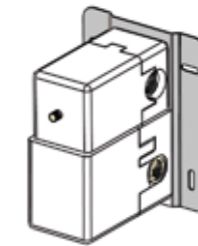

The valve is enclosed in a polystyrene box to prevent damage during installation.

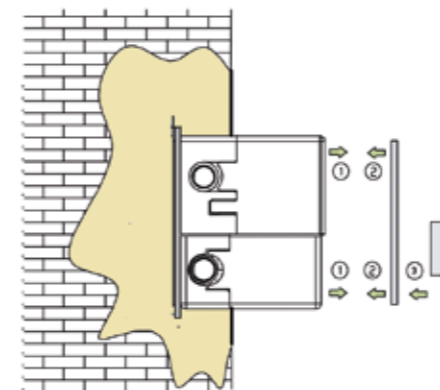

Once the valve has been fully installed and the wall made good and tiled the top half of the polystyrene box is removed and the finishing trim set is fitted.

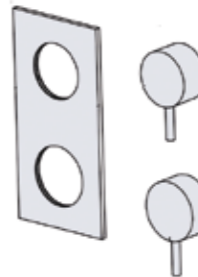

MINIME BRUSHED



BASIN MONO MIXER
MM.121BDN
without waste 0.5 bar MP
H: 150mm P: 119mm
£225



BASIN TALL MONO MIXER
MM.141BDN
without waste 0.5 bar MP
H: 317mm P: 119mm
£275



BASIN 2 HOLE WALL MIXER
MM.122BWN-BP
without waste 0.5 bar MP
P: 220mm
£445



BASIN MID MONO MIXER - SIDE LEVER
MM.131BDN-S
without waste 0.5 bar MP
H: 276mm P: 111mm
£275



BASIN TALL MONO MIXER - SIDE LEVER
MM.141BDN-S
without waste 0.5 bar MP
H: 396mm P: 141mm
£295



BASIN FLOOR MONO MIXER
MM.141BFN
without waste 1 bar HP
H: 1176mm P: 141mm
£795



BASIN 2 HOLE DECK MIXER
MM.122BDN
without waste 0.5 bar MP
H: 185mm P: 111mm
£295



BASIN 2 HOLE DECK MIXER
MM.142BDN
without waste 0.5 bar MP
H: 306mm P: 141mm
£345

MINIME BRUSHED



BIDET MONO MIXER
MM.221BDN
without waste 0.5 bar MP
H: 150mm P: 115mm
£225



BATH 3 HOLE WALL MIXER
MM.323BW-2
including shower kit
1 bar HP
£595



THERMO MULTI-FUNCTION SHOWER
MM.522BE-2
Exposed 2 outlet
1 bar HP
£1295

A full range of showering, accessories and wastes are available to match Minime brushed

MINIME BRUSHED



MANUAL BATH SHOWER MIXER

MM.322BE-2
Exposed with shower kit
P: 170mm 1 bar HP
£595

Brushed chrome is a durable and stylish hand crafted finish. The satin appearance achieved matches perfectly with brushed stainless steel.



MANUAL SHOWER VALVE

MM.411BR-1
Recessed 1 outlet
1 bar HP
£275



MANUAL SHOWER VALVE WITH DIVERTER

MM.422BR-2
Recessed 2 outlet
1 bar HP
£375



THERMO VALVE

MM.511BR-1
Recessed 1 outlet
1 bar HP
£445



THERMO VALVE WITH DIVERTER

MM.522BR-2
Recessed 2 outlet
1 bar HP
£545





vela

Designed by Armando Medina - Sienna

True simple lines creating contemporary style

RUBINETTERIE
treemme

82
LOW
Pb
Lead



VELA



BASIN MINI MONO MIXER
VE.111CDN
without waste 0.5 bar MP
H: 145mm P: 95mm
£165



BASIN MONO MIXER
VE.121CDN
without waste 0.5 bar MP
H: 164mm P: 131mm
£185



BASIN TALL MONO MIXER
VE.141CDN
without waste 0.5 bar MP
H: 324mm P: 150mm
£225

VELA



MANUAL BATH SHOWER MIXER
VE.322CE-2
Exposed with shower kit
P: 168mm 1 bar HP
£225



THERMO BATH SHOWER MIXER
VE.322CE-2T
Exposed with shower kit
P: 168mm 1 bar HP
£395



BASIN 2 HOLE WALL MIXER
VE.122CWN
without waste 0.5 bar MP
P: 200mm
£275



BASIN 2 HOLE WALL MIXER
VE.142CWN
without waste 0.5 bar MP
P: 260mm
£295



BIDET MONO MIXER
VE.221CDN
with waste 0.5 bar MP
H: 180mm P: 129mm
£215



THERMO EASYBOX SHOWER VALVE
VE.511CR-1
Recessed 1 outlet
1 bar HP
£295



THERMO EASYBOX VALVE WITH DIVERTER
VE.522CR-2
Recessed 2 outlet
1 bar HP
£395



THERMO EASYBOX VALVE WITH DIVERTER
VE.522CR-3
Recessed 3 outlet
3 bar HP
£495



BASIN 2 HOLE WALL MIXER
VE.122CWN-BP
without waste 0.5 bar MP
P: 210mm
£245



BASIN 2 HOLE WALL MIXER
VE.142CWN-BP
without waste 0.5 bar MP
P: 264mm
£265



VELA



MANUAL EASYBOX SHOWER VALVE

VE.411CR-1

Recessed 1 outlet

1 bar HP

£155



MANUAL EASYBOX VALVE WITH DIVERTER

VE.422CR-2

Recessed 2 outlet

1 bar HP

£195



MANUAL EASYBOX VALVE WITH DIVERTER

VE.422CR-3

Recessed 3 outlet

1 bar HP

£275

EASYBOX SYSTEM

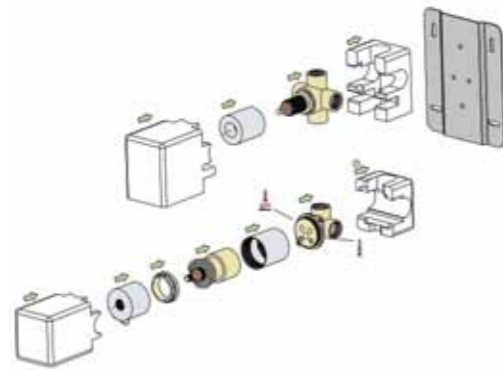

The shower valve is assembled and factory fitted onto a backplate which allows simple secure fixing to the wall.

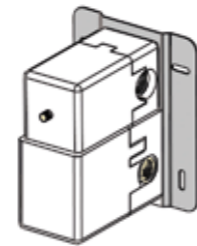

The valve is enclosed in a polystyrene box to prevent damage during installation.

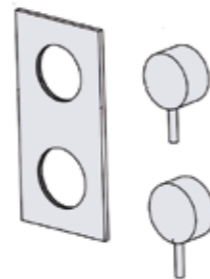
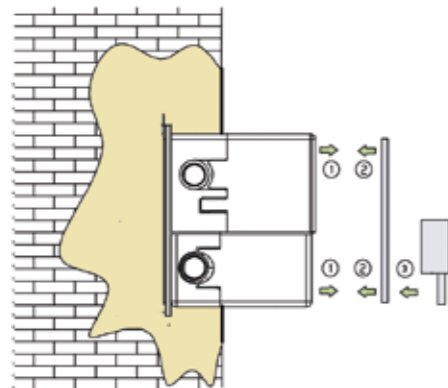

Once the valve has been fully installed and the wall made good and tiled the top half of the polystyrene box is removed and the finishing trim set is fitted.

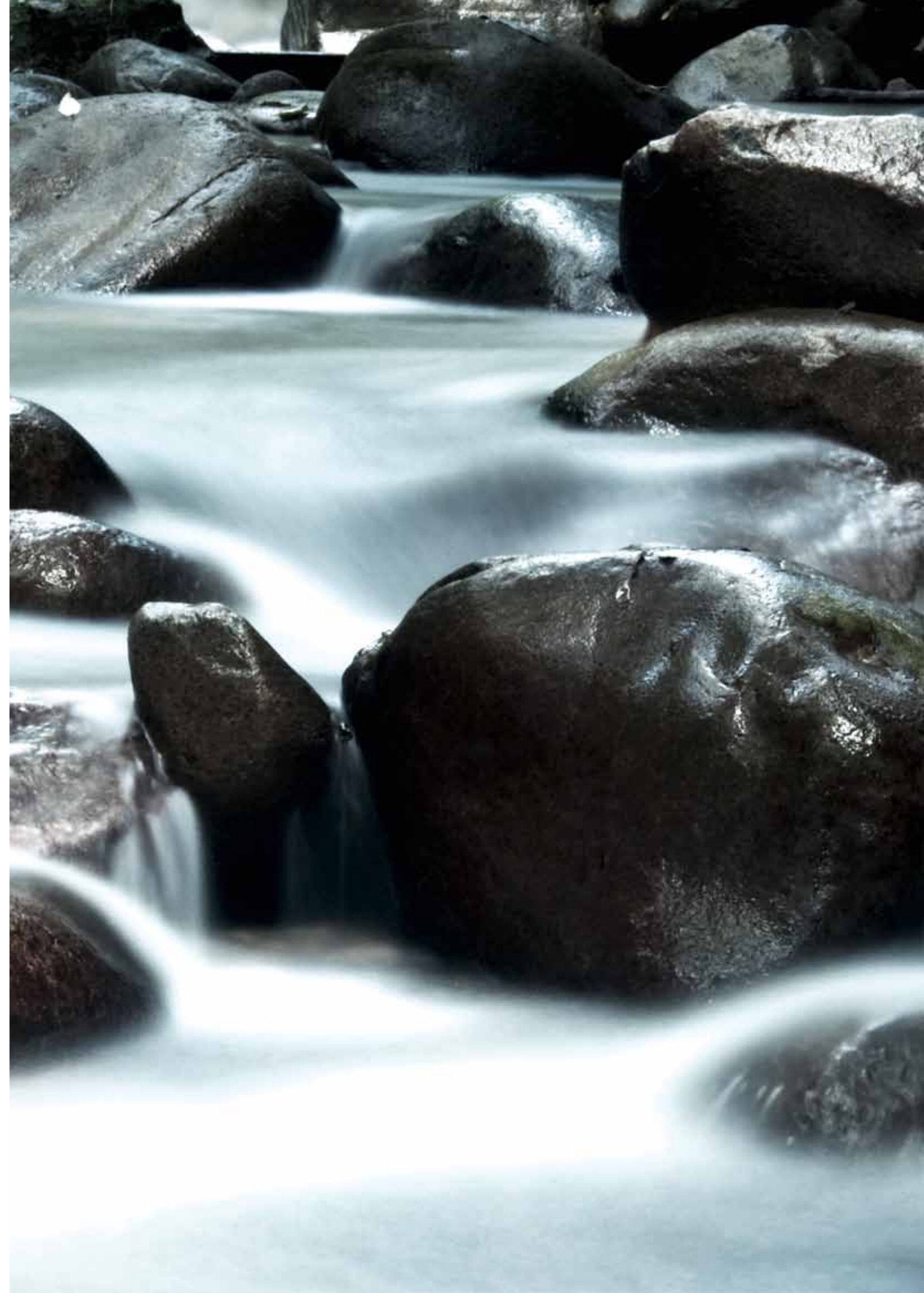



iko

Designed by Project I

Elegant simplicity





BASIN MONO MIXER

IK.121CDN
without waste 0.2 barLP
H: 148mm P: 115mm
£195



BASIN TALL MONO MIXER

IK.141CDN
without waste 0.2 barLP
H: 312mm P: 145mm
£235

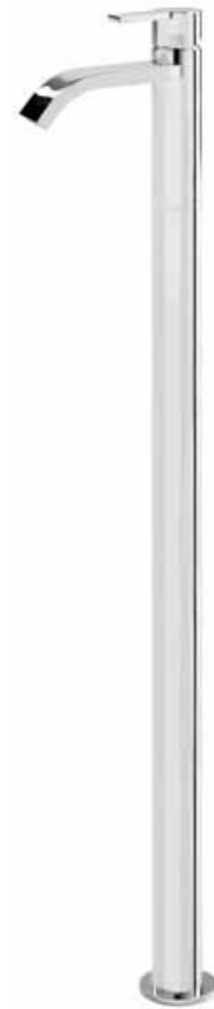

BASIN MONO FLOOR STANDING MIXER

IK.141CFN
without waste 1 bar HP
H: 1070mm P: 200mm
£675



BASIN 2 HOLE WALL MIXER

IK.122CWN
without waste 0.5 bar MP
P: 190mm
£245



BIDET MONO MIXER

IK.221CDN
without waste 0.2 barLP
H: 148mm P: 90mm
£195



MANUAL BATH SHOWER MIXER

IK.322CE-2
Exposed with shower kit
P: 195mm 1 bar HP
£395



MANUAL SHOWER VALVE

IK.421CR-1
Recessed 1 outlet
1 bar HP
£195



MANUAL VALVE WITH DIVERTER

IK.422CR-2
Recessed 2 outlet
1 bar HP
£265





vik

Designed by G Project

Discreet subtle curves form this modern design





BASIN MONO MIXER

VK.121CDN
without waste 0.2 barLP
H: 145mm P: 120mm
£125



BASIN MID MONO MIXER

VK.131CDN
without waste 0.2 barLP
H: 200mm P: 178mm
£145



BASIN TALL MONO MIXER

VK.141CDN
without waste 0.2 barLP
H: 335mm P: 178mm
£195



BIDET MONO MIXER

VK.221CDN
without waste 0.2 barLP
H: 145mm P: 118mm
£125



MANUAL BATH SHOWER MIXER

VK.322CE-2
Exposed with shower kit
P: 160mm 1 bar HP
£195



MANUAL SHOWER VALVE

VK.421CR-1
Recessed 1 outlet
0.5 bar MP
£95



MANUAL VALVE WITH DIVERTER

VK.422CR-2
Recessed 2 outlet
1 bar HP
£175





arte form individual

Arte Form Individual is a collection featuring the latest innovative designs and technology. These beautiful hand crafted products are individually made and are available in a variety of finishes.

For products that truly stand out from the crowd choose Arte Form Individual.

Arte Form Individual enables you to fully express your individual style and desired layout — whatever size of project you are designing. It offers you not only a choice of stylish finishes for your Arte Form product, including the latest Gold PVD (Physical Vapor Deposition) technology that creates an ultra hard wearing finish.

Arte Form Individual products are manufactured to order and so have a lead time of approximately six weeks.

Arte Form believe that we are all individuals and that one size does not fit all. Therefore, if your project has specific needs, please discuss with your dealer or visit the Individual section on www.arteform.co.uk



Finishes available: brushed chrome | gold | satin white | satin black | white corian





philo

Designed by Gianluca Belli PHI CUBO

Ultra-modern design, technological innovation
and energy-saving are the concepts behind PHILO.

Available in:

chrome

brushed chrome

satin white

satin black

treemme
RUBINETTERIE

82
Pb
Lead



PHILO



BASIN MONO MIXER
PH.121CDN
without waste 1 bar MP
H: 125mm P: 155mm
£525



BASIN MID MONO MIXER
PH.131CDN
without waste 1 bar LP
H: 185mm P: 184mm
£625



BASIN TALL MONO MIXER
PH.141CDN
without waste 1 bar MP
H: 275mm P: 180mm
£725



BASIN FLOOR MONO MIXER
PH.141CFN
without waste 1 bar HP
H: 1050mm P: 157mm
£1395



BASIN 1 HOLE WALL MIXER
PH.121CWN
without waste 1 bar MP
P: 200mm
£695



PHILO WALL FLANGE FOR PH.121CWN
PH.100WC
£50



BIDET MONO MIXER
PH.221CDN
without waste 1 bar MP
H: 110mm P: 112mm
£545

PHILO tall basin mono in satin white with chrome lever option



To see more of the colour options on the PHILO range visit www.arteform.co.uk



PHILO



MANUAL BATH SHOWER MIXER
 PH.322CE-2
 Exposed with shower kit
 P: 220mm 1 bar HP
£995



SHOWER HEAD
 SH.245C-440
 2 bar HP
 P: 440mm
£695



BATH MONO FLOOR STANDING MIXER
 PH.341CF-2
 1 bar HP
 H: 785mm P: 197mm OD: 297mm
£1995



THERMO MULTI-FUNCTION SHOWER COLUMN
 PH.542CE-2
 2 bar HP
 H: 1160mm P: 510mm
£1995



MANUAL MULTI-FUNCTION FLOOR STANDING SHOWER COLUMN
 PH.441CF-2
 2 bar HP
 H: 2115mm P: 387mm
£2495

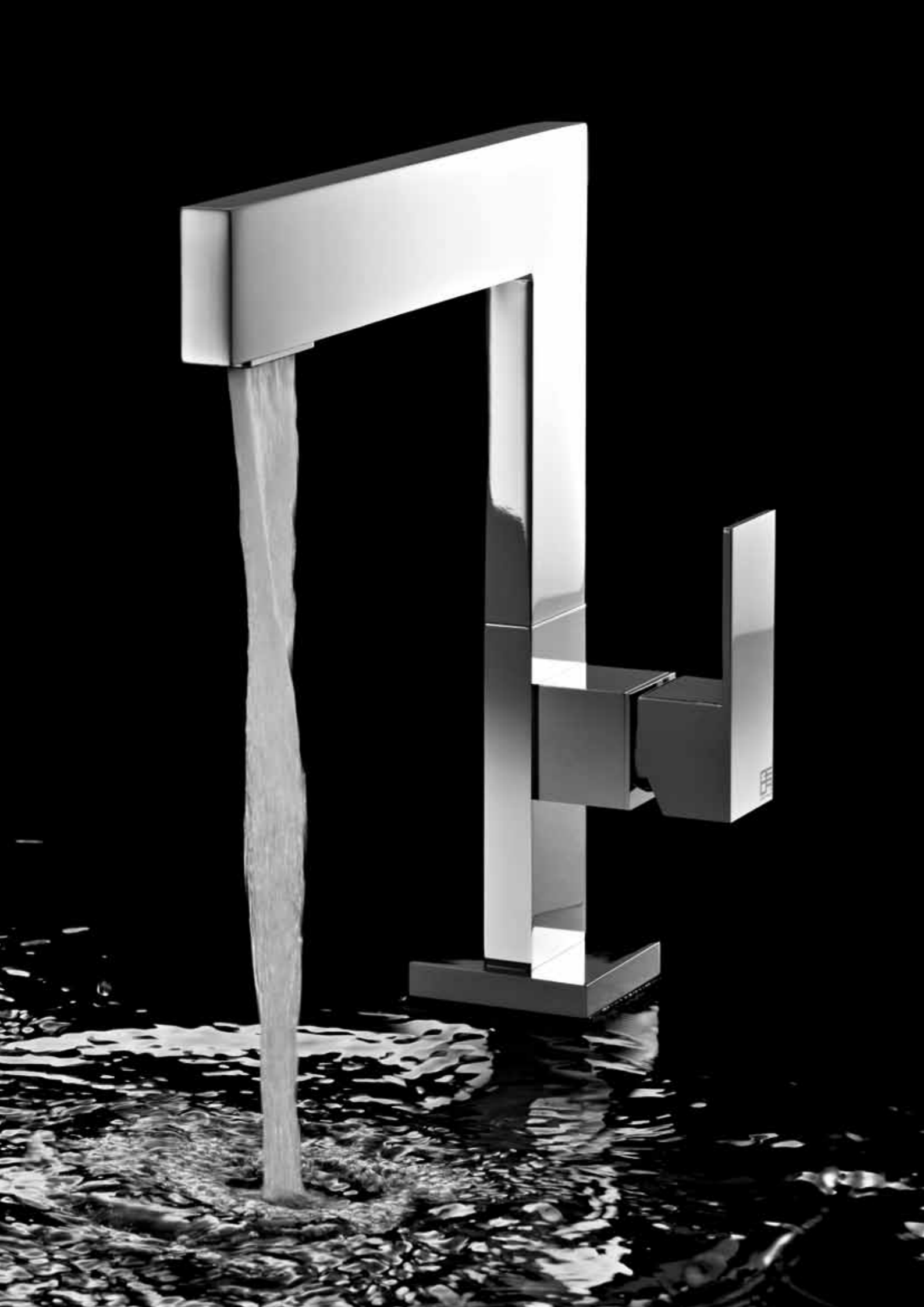

hito 51

Designed by Stefano Macchion — GEDA

A study in form, craftsman-like attention to detail & cutting edge technology

Available in:

chrome

brushed chrome

white corian

gold



HITO 51



BASIN MONO MIXER
HT.121CDN
without waste 1 bar HP
H: 180mm P: 111mm
£435



BASIN MID MONO MIXER
HT.131CDN
without waste 1 bar HP
H: 250mm P: 180mm
£455



BASIN TALL MONO MIXER
HT.141CDN
without waste 1 bar HP
H: 365mm P: 180mm
£495



BASIN MONO MIXER
HT.121CDN-F
without waste 1 bar HP
H: 245mm P: 124mm
£495



BASIN MID MONO MIXER
HT.131CDN-F
without waste 1 bar HP
H: 250mm P: 180mm
£495



BASIN TALL MONO MIXER
HT.141CDN-F
without waste 1 bar HP
H: 365mm P: 180mm
£595



BASIN 2 HOLE DECK MIXER
HT.122CDN-F
without waste 1 bar HP
H: 180mm P: 180mm
£565



BASIN 2 HOLE DECK MIXER
HT.122CDN
without waste 1 bar HP
H: 240mm P: 180mm
£535



BASIN 3 HOLE DECK MIXER
HT.123CDN
without waste 1 bar HP
H: 240mm P: 180mm
£575

HITO 51



BASIN 2 HOLE WALL MIXER
HT.122CWN
without waste 1 bar HP
P: 190mm
£475

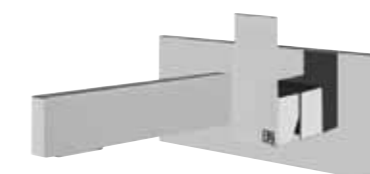

BASIN 2 HOLE WALL MIXER
HT.122CWN-BP
without waste 1 bar HP
P: 190mm
£475

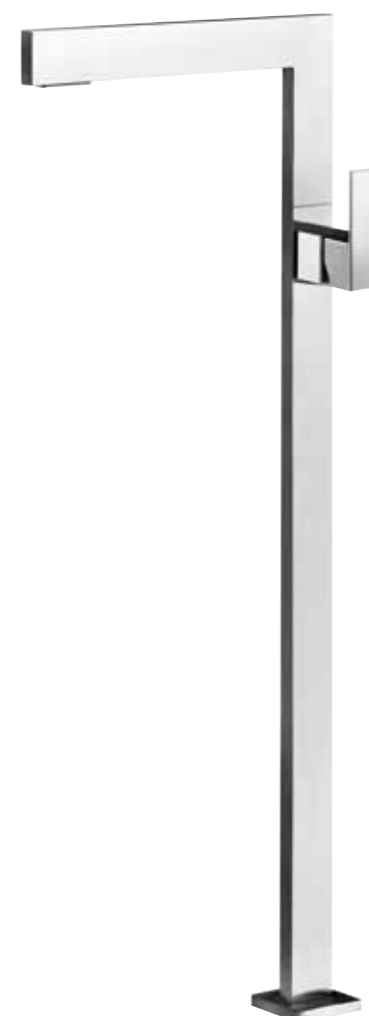

BASIN FLOOR MONO MIXER
HT.141CFN
without waste 1 bar HP
H: 1060mm P: 220mm
£995



HITO 51



THERMO BATH SHOWER MIXER
HT.322CE-2T
Exposed with shower kit & swivel spout
P: 180mm 1 bar HP
£595



BATH WALL SPOUT
HT.351CW-210
1 bar HP
P: 210mm
£175

HITO 51



SHOWER ARM
TM.231C-360
P: 360mm 1 bar HP
£295



SHOWER ARM
TM.231C-420
P: 420mm 1 bar HP
£345



SHOWER ARM
TM.231C-480
P: 480mm 1 bar HP
£375



MANUAL BATH SHOWER MIXER
HT.322CE-2
Exposed with shower kit
P: 175mm 1 bar HP
£595



MANIFOLD 3 WAY
TM.433M
£100



MANUAL SHOWER VALVE
HT.421CR-1
Recessed 1 outlet
1 bar HP
£255



MANUAL VALVE WITH DIVERTER
HT.422CR-2
Recessed 2 outlet
1 bar HP
£335



MANUAL VALVE DIVERTER & OUTLET
HT.423CR-2
Recessed 2 outlet
1 bar HP
£495



MANIFOLD 6 WAY
TM.436M
£150

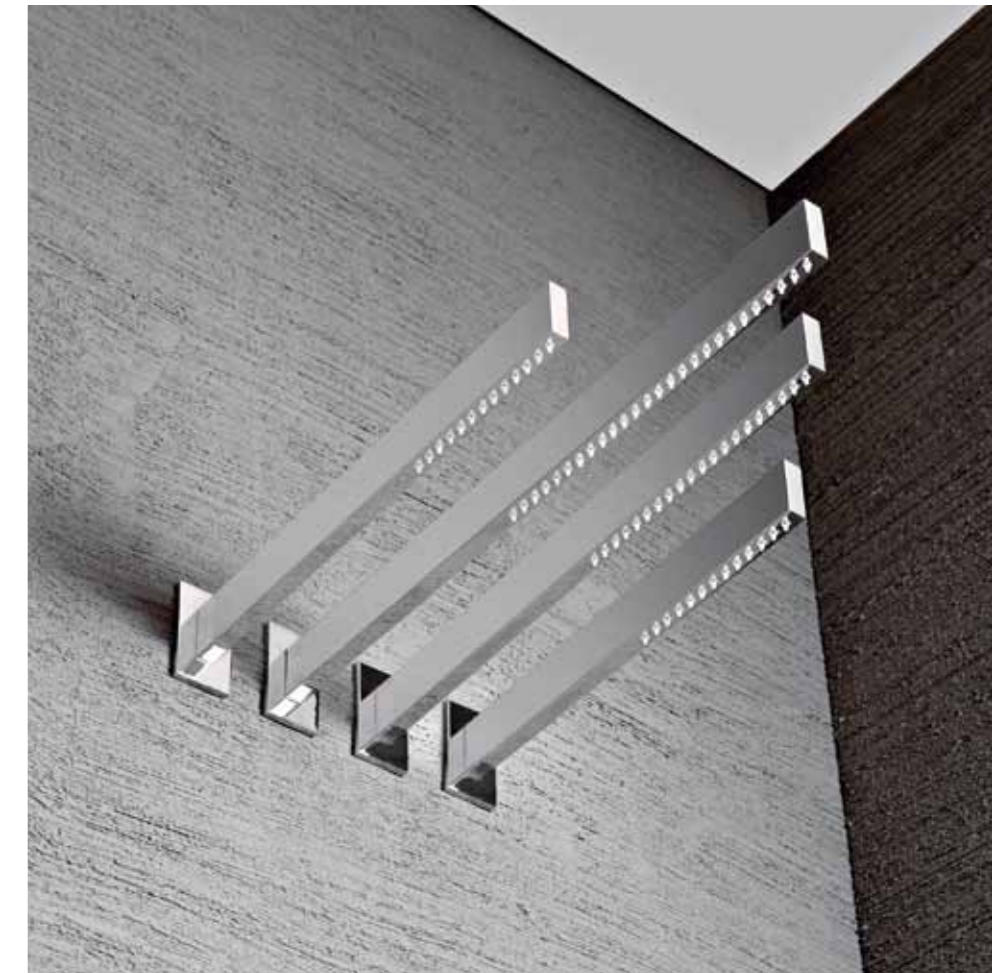



rajia

Designed by Stefano Macchion — GEDA

GEDA — An Italian hothouse of ideas
have created a purity of design in Rajia

Available in:

chrome

brushed chrome

satin white

gold



RAJIA



BASIN MONO MIXER
RJ.121CDN
without waste 1 bar HP
H: 235mm P: 134mm
£425



BASIN MID MONO MIXER
RJ.131CDN
without waste 1 bar HP
H: 300mm P: 167mm
£455



BASIN TALL MONO MIXER
RJ.141CDN
without waste 1 bar HP
H: 415mm P: 170mm
£495



BASIN MONO FLOOR STANDING MIXER
RJ.141CFN
without waste 1 bar HP
H: 1095mm P: 167mm
£995



BASIN 2 HOLE DECK MIXER
RJ.122CDN
without waste 1 bar HP
H: 230mm P: 167mm
£545



BIDET MONO MIXER
RJ.221CDN
without waste 1 bar HP
H: 235mm P: 134mm
£425



MANUAL BATH SHOWER MIXER
RJ.322CE-2
Exposed with shower kit
P: 179mm 1 bar HP
£525



RAJIA



BATH 4 HOLE DECK MIXER
RJ.324CD-2
including shower kit
1 bar HP
£825



BATH WALL SPOUT
RJ.351CW-185
1 bar HP
P: 185mm
£225



MANUAL SHOWER VALVE
RJ.421CR-1
Recessed 1 outlet
1 bar HP
£255



MANUAL VALVE WITH DIVERTER
RJ.422CR-2
Recessed 2 outlet
1 bar HP
£355



MANUAL VALVE DIVERTER & OUTLET
RJ.423CR-2
Recessed 2 outlet
1 bar HP
£495



arche & arche cascata

Designed by Danilo Fedeli — 3DF Tuscany

Winner of the 2011 Design Plus Award

A design that reflects the gentle flow of water in nature

Available in:

chrome

brushed chrome

satin white

satin black

RUBINETTERIE
treemme



ARCHE & ARCHE CASCATA



BASIN MINI MONO MIXER

with waste 1 bar HP
H: 140mm P: 120mm

AR.111CDN solid spout **£440**
AC.111CDN cascata spout **£495**



BASIN MONO MIXER

without waste 1 bar HP
H: 185mm P: 116mm

AR.121CDN solid spout **£455**
AC.121CDN cascata spout **£525**



BASIN TALL MONO MIXER

without waste 1 bar HP
H: 278mm P: 133mm

AR.141CDN solid spout **£560**
AC.141CDN cascata spout **£625**



BASIN FLOOR MONO MIXER

without waste 1 bar HP
H: 1117mm P: 220mm

AR.141CFN solid spout **£1575**
AC.141CFN cascata spout **£1695**



BASIN 2 HOLE WALL MIXER

without waste 1 bar HP
P: 190mm

AR.122CWN solid spout **£495**
AC.122CWN cascata spout **£555**



BASIN 3 HOLE WALL MIXER

without waste 1 bar HP
P: 190mm

AR.123CWN solid spout **£745**
AC.123CWN cascata spout **£795**



BASIN 3 HOLE DECK MIXER

without waste 1 bar HP
H: 185 P: 116mm

AR.123CDN solid spout **£670**
AC.123CDN cascata spout **£695**



BASIN WALL SPOUT

1 bar HP
P: 190mm

AR.151CW-190 solid spout **£280**
AC.151CW-190 cascata spout **£355**



To see more of Arche visit
www.arteform.co.uk

ARCHE & ARCHE CASCATA



MANUAL BATH SHOWER MIXER
AR.322CE-2
Exposed with shower kit
P: 175mm 1 bar HP
£930



BATH 5 HOLE DECK MIXER
AR.325CD-2
including shower kit
P: 116mm 1 bar HP
£995

ARCHE & ARCHE CASCATA



CASCATA WATERFALL WALL FILLER
1 bar HP
W: 250mm H: 135mm P: 110mm
SH.244C Chrome **£375**
SH.244B Brushed **£395**



SHOWER WATERFALL WALL MOUNTED
H: 60mm W: 145mm P: 70mm
2 bar HP
SH.232C-145 **£425**



ARCHE SHOWER HEAD AND ARM
SH.241C-370
2 bar HP
P: 370mm
£695



MANUAL SHOWER VALVE
AR.422CR-1
Recessed 1 outlet
1 bar HP
£195



MANUAL VALVE WITH DIVERTER
AR.423CR-2
Recessed 2 outlet
1 bar HP
£275



MANUAL VALVE WITH DIVERTER
AR.423CR-2
Recessed 3 outlet
1 bar HP
£325



THERMO SHOWER VALVE
AR.522CR-1
Recessed 1 outlet
1 bar HP
£395



THERMO VALVE WITH DIVERTER
AR.523CR-2
Recessed 2 outlet
1 bar HP
£495



THERMO VALVE WITH DIVERTER
AR.523CR-3
Recessed 3 outlet
2 bar HP
£595



BATH MONO FLOOR STANDING MIXER
AR.341CF-2
1 bar HP
H: 917mm P: 220mm
£1795

Shower Kits

Shower kits feature either a slide rail kit or a fixed handset holder. A slide rail kit is an extremely popular option as it provides easy height adjustment of the shower handset for all of the family. A fixed handset holder is suitable for either adding to a fixed shower head option or over a bath. Arte Form provide a range of slide rail and handset options to enable you to create your perfect shower kit.

Fixed Heads

Fixed heads offer a rainfall type shower with a larger spray pattern than a hand shower. They are available in either wall or ceiling mounted options. Combining a fixed head with a hand shower provides the ultimate flexibility (this option requires a two outlet shower valve to be fitted).



Skyfall

The Skyfall range features showerheads that fit flush with the ceiling and incorporate features such as waterfall outlets and nebulizers.



Spa

Arte Form Spa allows you to re-create the most luxurious spa shower system in your own home, featuring a range of body jets, spray plates and waterfall outlets.

Spa is the ultimate showering experience.



showering

Creating the perfect showering experience is simplicity itself with the Arte Form Showering Collection. Select from a range of the latest styles of shower kits, fixed heads or for the ultimate sensation one of our Skyfall ceiling mounted multi-function heads.

All Arte Form shower handsets and fixed heads incorporate anti-limescale, easy to clean silicon jets, which are particularly useful in hard water areas.

The Varo range features a removable section that makes cleaning even simpler.



KITS

Add any single outlet recessed valve and the built in diverter in SOLO allows for the valve to be positioned anywhere, ideal for walk in showers.



EASYSOFT SHOWER HOSE SMOOTH

1.5m
 SH.740C Chrome **£30**
 SH.740W White **£30**
 SH.740N Black **£30**
 SH.740B Brushed **£30**



SOLO MULTI FUNCTION SHOWER COLUMN

inc diverter
 SH.215C-200
 0.5 bar MP
£565



VIK SHOWER SLIDE RAIL KIT
 inc rail hose handset & outlet

SH.113C
 0.5 bar MP
£125

KITS



SLIM SHOWER SLIDE RAIL

H: 800mm
 SH.111C Chrome **£80**
 SH.111B Brushed **£115**



ASTA SHOWER SLIDE RAIL

H: 600mm
 SH.112C Chrome **£75**
 SH.112B Brushed **£115**



QUADRA SHOWER SLIDE RAIL

H: 700mm
 SH.121C Chrome **£145**
 SH.121B Brushed **£185**



FLOW WALL OUTLET & HOLDER

SH.615C Chrome **£55**
 SH.615B Brushed **£75**



BIRO WALL OUTLET & HOLDER

SH.625C Chrome **£60**
 SH.625B Brushed **£80**



CURVE WALL OUTLET

SH.624C Chrome **£55**
 SH.624B Brushed **£70**



FLOW WALL OUTLET

SH.613C Chrome **£40**
 SH.613B Brushed **£60**



BIRO WALL OUTLET

SH.623C Chrome **£55**
 SH.623B Brushed **£70**

KITS



PUKKA SHOWER HANDSET - ABS
SINGLE MODE
SH.711C-130
0.5 bar MP
W: 130mm
£55



PUKKA SHOWER HANDSET - ABS
3 MODE
SH.712C-100
0.5 bar MP
W: 100mm
£65



PUKKA SHOWER HANDSET - ABS
SINGLE MODE
SH.711C-100
0.2 bar LP
W: 100mm
£45



CIKA SHOWER HANDSET - ABS
2 MODE
SH.713C-100
0.5 bar MP
W: 100mm
£65



BOB SHOWER HANDSET - ABS
SINGLE MODE
SH.711C-80
0.2 bar LP
W: 80mm
£35



HITO 51 SHOWER HANDSET -
ABS SINGLE MODE
SH.721C
0.2 bar LP
H: 185mm
£35



FLOW SHOWER HANDSET - ABS
SINGLE MODE
H: 180mm 0.5 bar MP
SH.722C Chrome **£25**
SH.722B Brushed **£45**



FLOW SHOWER HANDSET -
BRASS SINGLE MODE
H: 180mm 0.5 bar MP
SH.723C Chrome **£45**
SH.723B Brushed **£65**



CURVE SHOWER HANDSET - ABS
SINGLE MODE
H: 200mm 0.5 bar MP
SH.727C Chrome **£40**
SH.727B Brushed **£60**

KITS



BIRO SHOWER HANDSET - ABS
SINGLE MODE
H: 210mm 0.5 bar MP
SH.724C Chrome **£45**
SH.724B Brushed **£75**



BIRO SHOWER HANDSET - BRASS
SINGLE MODE
H: 210mm 0.5 bar MP
SH.725C Chrome **£85**
SH.725B Brushed **£105**



VIK HOSE HANDSET & WALL
OUTLET
SH.614C
0.2 bar LP
£95



FLOW HOSE HANDSET & WALL
OUTLET
SH.611C
0.2 bar LP
£175



ON OFF HOSE HANDSET &
WALL OUTLET
SH.612C
0.5 bar LP
£155



ITAP HOSE HANDSET & WALL
OUTLET
SH.621C
0.5 bar MP
£195



ITAP HOSE HANDSET & WALL
BRACKET
SH.622C
0.5 bar MP
£195



NANOTECH HOSE HANDSET &
WALL OUTLET
SH.626C
1 bar HP
£425



S22 HOSE HANDSET & WALL
OUTLET
SH.611S
0.5 bar MP
£225



fixed heads & arms

Arte Form fixed heads are available in a choice of sizes, shapes and finishes to enable you to select the perfect shower for your bathroom.

All Arte Form fixed heads feature an anti-limescale silicon jets for easy cleaning.

TIME shower arms provide a unique opportunity to design your own showering experience — simply select between one and six shower arms with a choice of three lengths to design exactly the shower you have always wanted

FIXED HEADS & ARMS



BEST FIXED SHOWER HEAD
200MM ROUND
Polished stainless steel
2mm thickness
SH.212C-200
1 bar HP
£175



BEST FIXED SHOWER HEAD
300MM ROUND
Polished stainless steel
2mm thickness
SH.212C-300
1 bar HP
£275



BEST FIXED SHOWER HEAD
400MM ROUND
Polished stainless steel
2mm thickness
SH.212C-400
1 bar HP
£395



BEST FIXED SHOWER HEAD
200MM ROUND
Brushed stainless steel
2mm thickness
SH.212B-200
1 bar HP
£195



BEST FIXED SHOWER HEAD
300MM ROUND
Brushed stainless steel
2mm thickness
SH.212B-300
1 bar HP
£295



BEST FIXED SHOWER HEAD
400MM ROUND
Brushed stainless steel
2mm thickness
SH.212B-400
1 bar HP
£425



DRUM FIXED SHOWER HEAD
200MM ROUND
Chrome plated ABS
13mm thickness
SH.214C-200
1 bar HP
£95



VARO FIXED SHOWER HEAD
225MM ROUND
Polished stainless steel
10mm thickness
SH.213C-225
1 bar HP
£195



VARO FIXED SHOWER HEAD
325MM ROUND
Polished stainless steel
10mm thickness
SH.213C-325
1 bar HP
£295



DRUM FIXED SHOWER HEAD
200MM ROUND
Brushed chrome ABS
13mm thickness
SH.214B-200
1 bar HP
£155



VARO FIXED SHOWER HEAD
225MM ROUND
Brushed stainless steel
10mm thickness
SH.213B-225
1 bar HP
£225



VARO FIXED SHOWER HEAD
325MM ROUND
Brushed stainless steel
10mm thickness
SH.213B-325
1 bar HP
£325

FIXED HEADS & ARMS

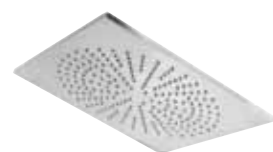

BEST FIXED SHOWER HEAD
200MM SQUARE

Polished stainless steel
2mm thickness
SH.221C-200
1 bar HP
£195

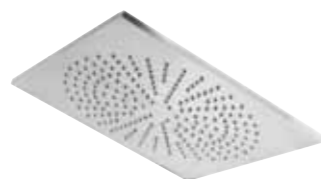

BEST FIXED SHOWER HEAD
300MM SQUARE

Polished stainless steel
2mm thickness
SH.221C-300
1 bar HP
£295

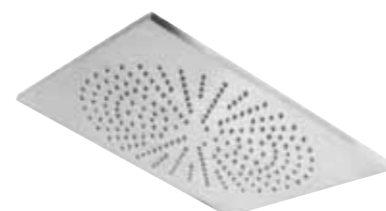

BEST FIXED SHOWER HEAD
400MM SQUARE

Polished stainless steel
2mm thickness
SH.221C-400
1 bar HP
£425

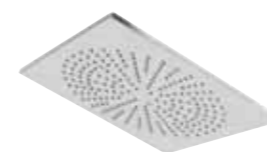

BEST FIXED SHOWER HEAD
200MM SQUARE

Brushed stainless steel
2mm thickness
SH.221B-200
1 bar HP
£225

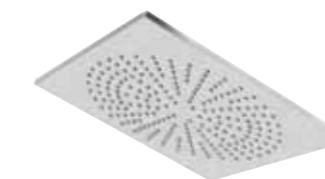

BEST FIXED SHOWER HEAD
300MM SQUARE

Brushed stainless steel
2mm thickness
SH.221B-300
1 bar HP
£325

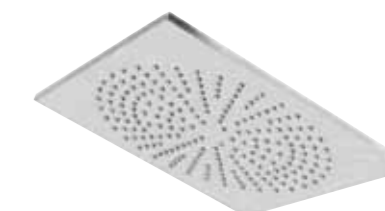

BEST FIXED SHOWER HEAD
400MM SQUARE

Brushed stainless steel
2mm thickness
SH.221B-400
1 bar HP
£455



DRUM FIXED SHOWER HEAD
200MM SQUARE

Chrome plated ABS
13mm thickness
SH.224C-200
1 bar HP
£95



VARO FIXED SHOWER HEAD
225MM SQUARE

Polished stainless steel
10mm thickness
SH.223C-225
1 bar HP
£225



VARO FIXED SHOWER HEAD
325MM SQUARE

Polished stainless steel
10mm thickness
SH.223C-325
1 bar HP
£325



DRUM FIXED SHOWER HEAD
200MM SQUARE

Brushed chrome ABS
13mm thickness
SH.224B-200
1 bar HP
£155

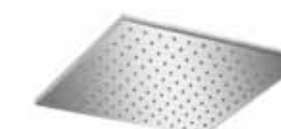

VARO FIXED SHOWER HEAD
225MM SQUARE

Brushed stainless steel
10mm thickness
SH.223B-225
1 bar HP
£255

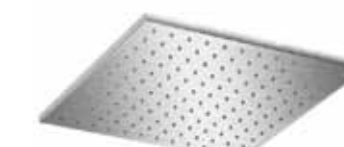

VARO FIXED SHOWER HEAD
325MM SQUARE

Brushed stainless steel
10mm thickness
SH.223B-325
1 bar HP
£355

FIXED HEADS & ARMS



PHILO SHOWER HEAD
SH.245C-400
2 bar HP
P: 440mm
£695



ARCHE SHOWER HEAD AND ARM
SH.246C-370
2 bar HP
P: 370mm
£695



SHOWER ARM
TM.231C-360 Chrome
TM.231B-360 Brushed
P: 360mm 1 bar HP

£295
£380



SHOWER ARM
TM.231C-420 Chrome
TM.231B-420 Brushed
P: 420mm 1 bar HP

£345
£450



SHOWER ARM
TM.231C-480 Chrome
TM.231B-480 Brushed
P: 480mm 1 bar HP

£375
£490



MANIFOLD 3 WAY
TM.433M
£100



MANIFOLD 6 WAY
TM.436M
£150



VELA SHOWER HEAD 3 MODE
W: 65mm P: 170mm
1 bar HP
SH.211C Chrome
£115

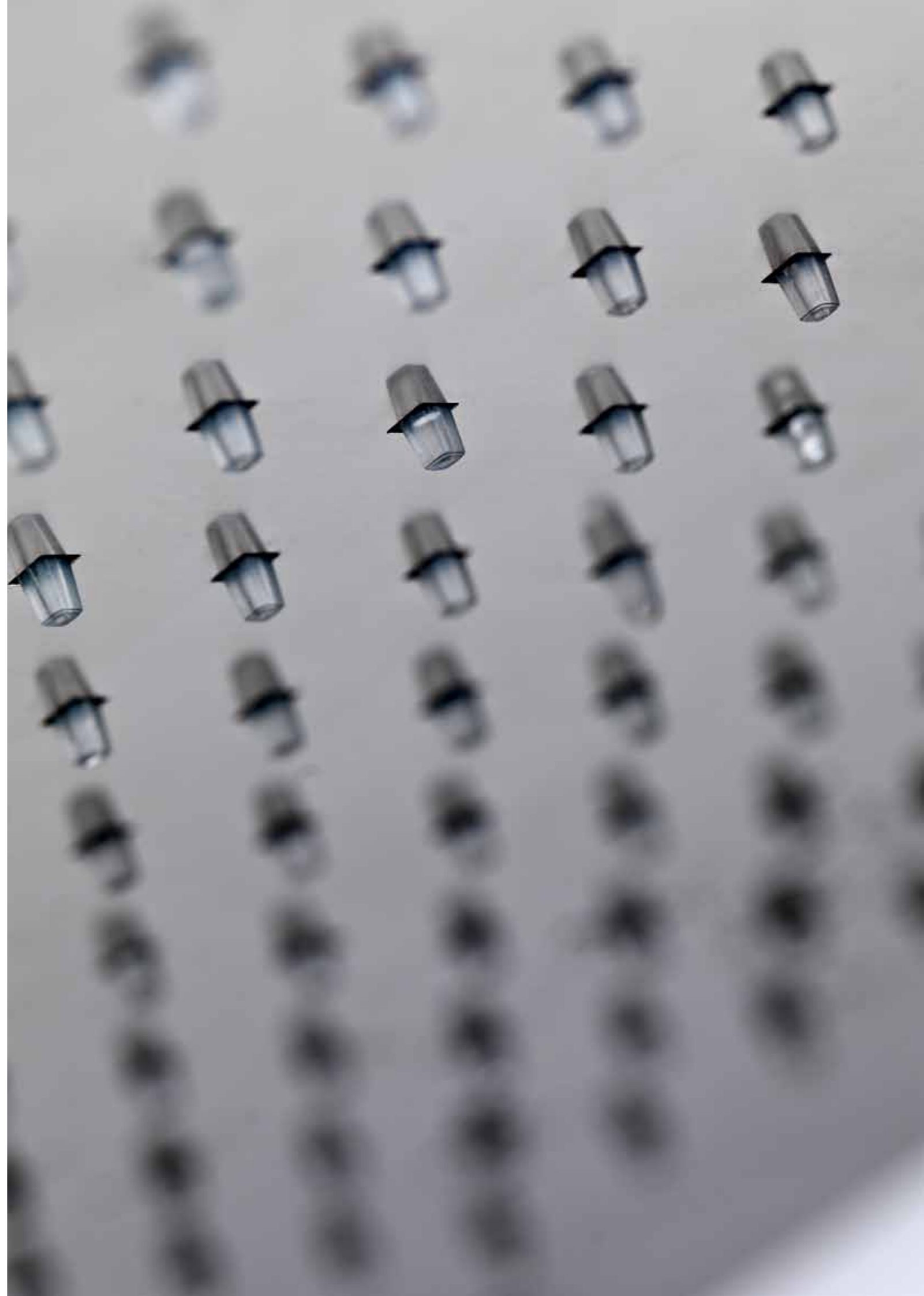

FIXED HEADS & ARMS



ROUND WALL ARM 365MM
 SH.411C-365 Chrome **£65**
 SH.411C-365 Brushed **£85**



MITRE WALL ARM 350MM
 SH.412C-350 Chrome **£75**
 SH.412B-350 Brushed **£95**



SQUARE WALL ARM 350MM
 SH.421C-350 Chrome **£105**
 SH.421B-350 Brushed **£175**

FIXED HEADS & ARMS

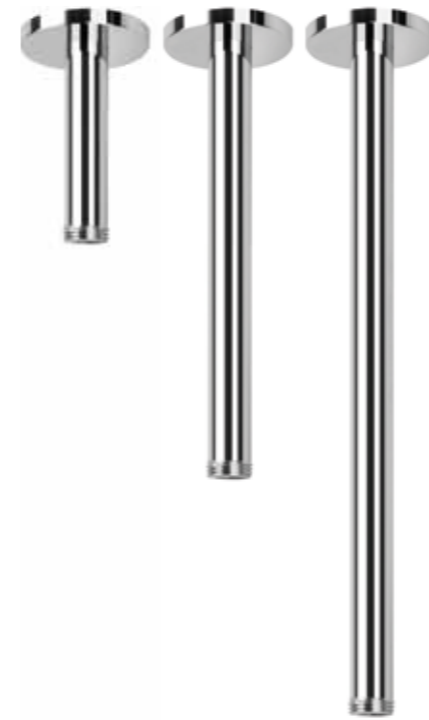

ROUND CEILING ARM — BRASS
 SH.511C-100 Chrome **£45**
 SH.511C-200 Chrome **£65**
 SH.511C-300 Chrome **£95**
 SH.511B-100 Brushed **£65**
 SH.511B-200 Brushed **£95**
 SH.511B-300 Brushed **£145**

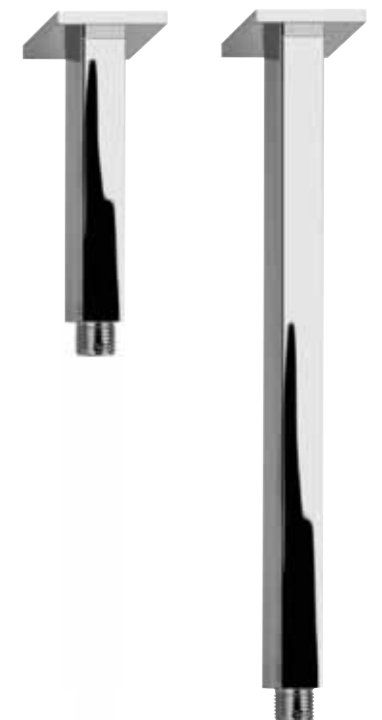

SQUARE CEILING ARM — BRASS
 SH.521C-150 Chrome **£65**
 SH.521C-300 Chrome **£125**
 SH.521B-150 Brushed **£95**
 SH.521B-300 Brushed **£175**



ROUND REINFORCING KIT
 SH.413C Chrome **£15**
 SH.413B Brushed **£20**



SQUARE REINFORCING KIT
 SH.422C Chrome **£25**
 SH.422B Brushed **£30**



skyfall

Skyfall by Arte Form is the ultimate in fixed head shower technology. Featuring a range of ceiling mounted, flush fitting shower plates that include both waterfall outlets and nebulizers, this is the pinnacle of showering excellence.

The Cube and Tube ranges add a twist of designer know how to showering to complete your Arte Form experience.

SKYFALL

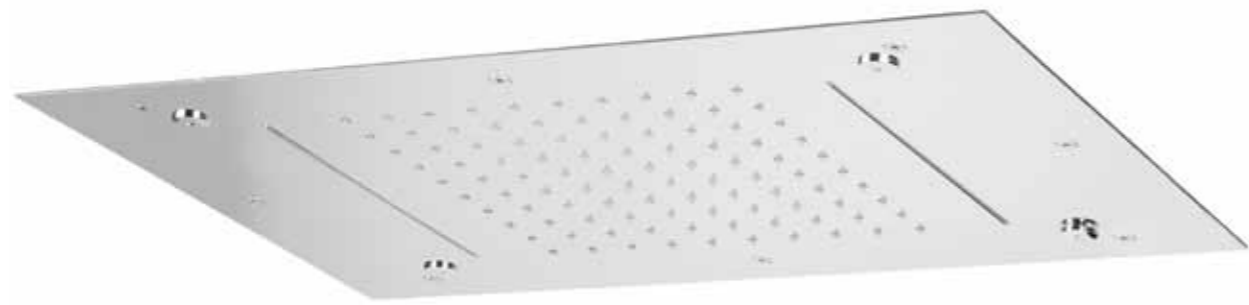

SKYFALL FLUSH FITTING RECTANGULAR CEILING MOUNT SHOWER HEAD

Polished or Brushed Stainless Steel

2 waterfalls 4 nebulizers

2 bar HP W:950mm D: 400mm

SH.323C Polished Steel **£2295**

SH.323B Brushed Steel **£2395**

SKYFALL FLUSH FITTING RECTANGULAR CEILING MOUNT SHOWER HEAD

Polished or Brushed Stainless Steel

2 waterfalls 4 nebulizers

2 bar HP W: 700mm D: 400mm

SH.325C Polished steel **£1995**

SH.325B Brushed steel **£2095**



SKYFALL FLUSH FITTING RECTANGULAR CEILING MOUNT SHOWER HEAD

Polished or Brushed Stainless Steel

2 bar HP W: 950mm D: 400mm

SH.311C Polished steel **£1695**

SH.311B Brushed steel **£1795**

SKYFALL FLUSH FITTING RECTANGULAR CEILING MOUNT SHOWER HEAD

Polished or Brushed Stainless Steel

2 bar HP W: 700mm D: 400mm

SH.324C Polished steel **£1495**

SH.324B Brushed steel **£1595**



SKYFALL



SKYFALL FLUSH FITTING CEILING MOUNT SHOWER HEAD
430MM SQUARE

Polished or Brushed Stainless Steel
2 waterfalls 4 nebulizers
2 bar HP W: 430mm
SH.332C Polished steel **£1895**
SH.332B Brushed steel **£1995**

SKYFALL FLUSH FITTING CEILING MOUNT SHOWER HEAD
430MM SQUARE

Polished or Brushed Stainless Steel
2 bar HP W: 430mm
SH.331C Polished steel **£1295**
SH.331B Brushed steel **£1395**

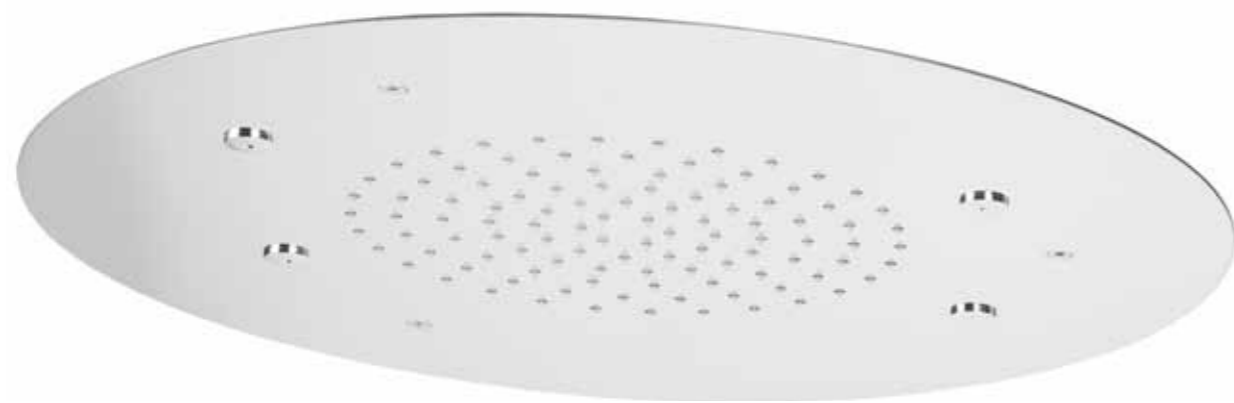

SKYFALL FLUSH FITTING CEILING MOUNT SHOWER HEAD
550MM ROUND

Polished or Brushed Stainless Steel
4 nebulizers
2 bar HP D: 550mm
SH.335C Polished steel **£1695**
SH.335B Brushed steel **£1795**

SKYFALL FLUSH FITTING CEILING MOUNT SHOWER HEAD
550MM ROUND

Polished or Brushed Stainless Steel
2 bar HP D: 550mm
SH.334C Polished steel **£1395**
SH.334B Brushed steel **£1495**

SKYFALL

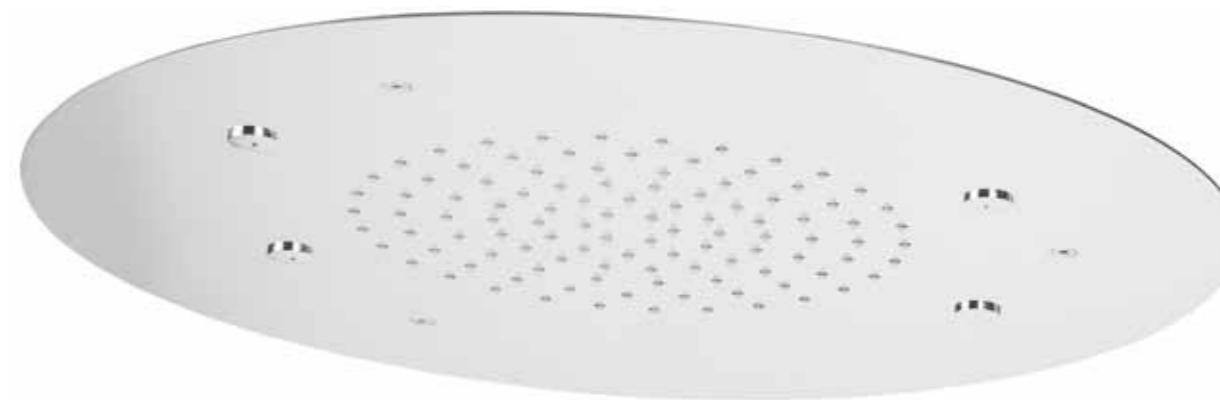

SKYFALL FLUSH FITTING CEILING MOUNT SHOWER HEAD
400MM ROUND

Polished or Brushed Stainless Steel
4 nebulizers
2 bar HP D: 400mm
SH.337C Polished steel **£1595**
SH.337B Brushed steel **£1695**

SKYFALL FLUSH FITTING CEILING MOUNT SHOWER HEAD
300MM ROUND

Polished or Brushed Stainless Steel
4 nebulizers
2 bar HP D: 300mm
SH.339C Polished steel **£1495**
SH.339B Brushed steel **£1595**

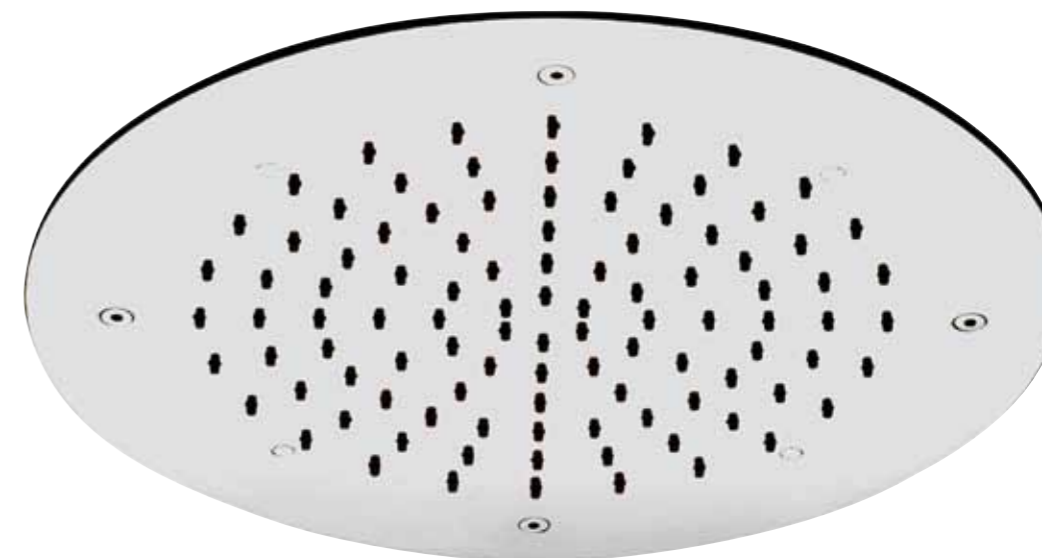

SKYFALL FLUSH FITTING CEILING MOUNT SHOWER HEAD
400MM ROUND

Polished or Brushed Stainless Steel
2 bar HP D: 400mm
SH.336C Polished steel **£1295**
SH.336B Brushed steel **£1395**

SKYFALL FLUSH FITTING CEILING MOUNT SHOWER HEAD
300MM ROUND

Polished or Brushed Stainless Steel
2 bar HP D: 300mm
SH.338C Polished steel **£1195**
SH.338B Brushed steel **£1295**

SKYFALL



CUBE CEILING MOUNT SHOWER HEAD

Polished or Brushed Stainless Steel

Finish inc 2 waterfalls

2 bar HP

H: 180mm W: 255mm

SH.322C-255 Polished steel **£895**

SH.322B-255 Brushed steel **£975**

CUBE CEILING MOUNT SHOWER HEAD

Polished or Brushed Stainless Steel

Finish

2 bar HP

H: 180mm W: 255mm

SH.321C-255 Polished steel **£595**

SH.321B-255 Brushed steel **£625**

SKYFALL



CUBE WALL MOUNT SHOWER HEAD

Polished or Brushed Stainless Steel

Finish inc waterfall

2 bar HP

W: 300mm X 260mm P: 185mm

SH.234C-300 Polished steel **£895**

SH.243B-300 Brushed steel **£975**

CUBE WALL MOUNT SHOWER HEAD

Polished or Brushed Stainless Steel

Finish

2 bar HP

W: 155mm P: 160mm

SH.222C-155 Polished steel **£475**

SH.222B-155 Brushed steel **£495**



ITAP WALL MOUNT SHOWER HEAD

W: 100mm P: 500mm

2 bar HP

SH.231C-500 **£495**

ITAP WALL MOUNT SHOWER HEAD

W: 200mm P: 500mm

2 bar HP

SH.232C-500 Polished steel **£695**

SH.232B-500 Brushed steel **£795**



ON OFF WALL MOUNT SHOWER HEAD

1 bar HP

W: 30mm P: 60mm

SH.243C-30 **£175**

ON OFF WALL MOUNT SHOWER HEAD

Polished or Brushed Stainless Steel

Finish

2 bar HP

W: 155mm P: 155mm

SH.241C-155 Polished steel **£445**

SH.241B-155 Brushed steel **£495**



spa

Arte Form Spa provides the opportunity for you to recreate the feeling of a luxurious spa retreat in your own home. Adjustable body jets or spray plates will ease tired muscles, while Cascata waterfall outlets will wash away the stresses of everyday life.

SPA



VARO BODY SPRAY

1 bar HP
W: 130mm
SH.811C Chrome **£110**
SH.811B Brushed **£150**



CURVE BODY SPRAY

1 bar HP
W: 125mm
SH.821C Chrome **£110**
SH.821B Brushed **£150**



QUAD BODY SPRAY

1 bar HP
W: 125mm
SH.822C Chrome **£110**
SH.822B Brushed **£150**

SPA



CASCATA WATERFALL WALL FILLER

1 bar HP
W: 270mm H: 50mm
SH.236C Chrome **£495**
SH.236B Brushed **£525**



CASCATA WATERFALL WALL FILLER

1 bar HP
W: 270mm H: 50mm
SH.242C Chrome **£525**
SH.242B Brushed **£545**



CASCATA WATERFALL WALL FILLER

1 bar HP
W: 250mm H: 135mm P: 110mm
SH.244C Chrome **£375**
SH.244B Brushed **£395**



Body sprays can add another dimension to your showering pleasure. Your desired number of jets can be individually positioned to create the feeling of a luxurious spa in your own home



BEST BODY SPRAY PLATE

1 bar HP
H: 300mm W: 50mm
SH.831C Chrome **£175**
SH.831B Brushed **£195**



DOUCHE KIT

NT.221CW **£225**
0.5 bar MP



SHOWER WATERFALL WALL MOUNTED

H: 60mm W: 145mm P: 70mm
2 bar HP **£425**
SH.232C-145



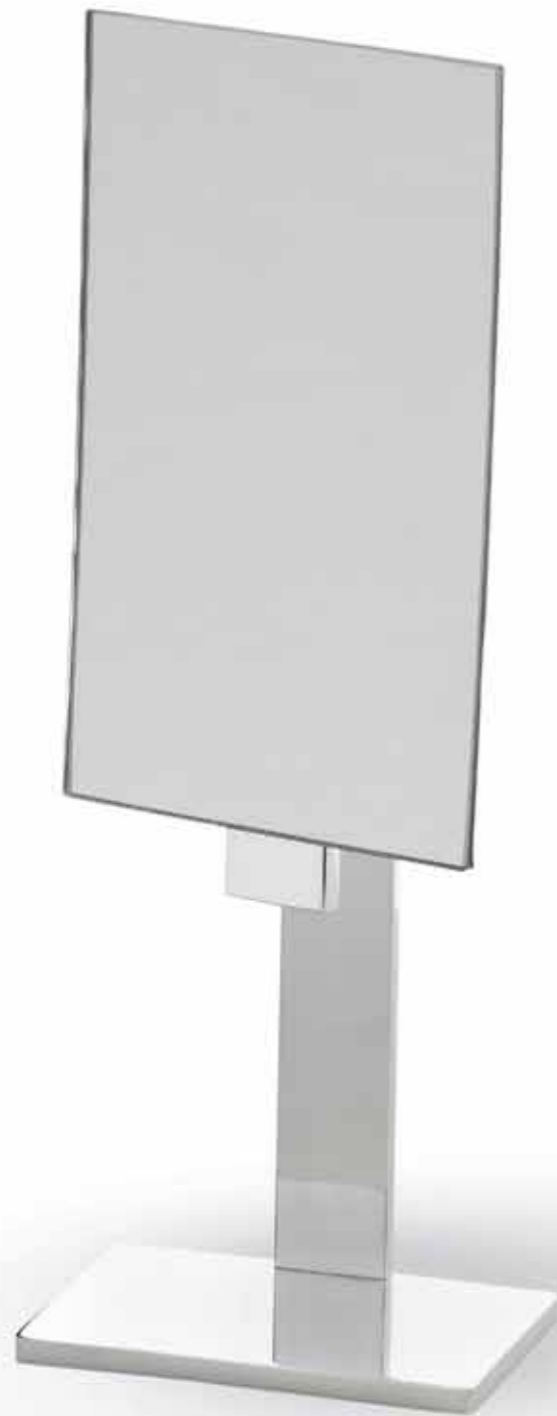

accessories & wastes

Arte Form accessories are manufactured from either solid brass with a durable chrome finish, or the S22 range designed by Eduardo Souto De Moura, manufactured in high grade brushed stainless steel.

ACCESSORIES



DEEP SOAP DISH
Chrome
DP.301C
£40



DEEP LIQUID SOAP DISPENSER
Chrome
DP.303C
£70



DEEP TOILET BRUSH HOLDER
Chrome
DP.103C
£100



DEEP SOAP DISH WALL MOUNTED
Chrome
DP.302C
£60



DEEP LIQUID SOAP DISPENSER WALL MOUNTED
Chrome
DP.304C
£80



DEEP TOILET BRUSH HOLDER WALL MOUNTED
Chrome
DP.104C
£110



DEEP TOILET ROLL HOLDER
Chrome
DP.101C
£60



DEEP SPARE TOILET ROLL HOLDER
Chrome
DP.102C
£70



DEEP SHOWER / BATH RACK
Chrome
DP.404C
W: 300mm D: 90mm
£130

ACCESSORIES



DEEP TOWEL RAIL 175MM
Chrome
DP.201C
£80



DEEP ROBE HOOK
Chrome
DP.501C
£30



DEEP VANITY MIRROR
Chrome
DP.511C
£170



DEEP TOWEL RAIL 350MM
Chrome
DP.202C
£120



DEEP TOWEL ARM 300MM
Chrome
DP.205C
£80



DEEP TOWEL RAIL 600MM
Chrome
DP.203C
£180



DEEP DOUBLE TOWEL RAIL 600MM
Chrome
DP.204C
£280

ACCESSORIES



S22 TRIANGLE SOAP DISH
Stainless steel
SS.301S
£55



S22 LIQUID SOAP DISPENSER
Stainless steel
SS.303S
£90



S22 TOILET BRUSH HOLDER
Stainless steel
SS.103S
£120



S22 SQUARE SOAP DISH
Stainless steel
SS.302S
£55



S22 LIQUID SOAP DISPENSER WALL MOUNTED
Stainless steel
SS.304S
£100



S22 TOILET BRUSH HOLDER WALL MOUNTED
Stainless steel
SS.104S
£130



S22 TOILET ROLL HOLDER
Stainless steel
SS.101S
£100



S22 DOUBLE TOILET ROLL HOLDER
Stainless steel
SS.102S
£110



S22 SHOWER / BATH RACK
Stainless steel
SS.404S
300mm D: 90mm
£150

ACCESSORIES



S22 ROBE HOOK
Stainless steel
SS.501S
£50



S22 SINGLE TOWEL RAIL
Stainless steel
SS.201S 200mm £70
SS.202S 300mm £80
SS.203S 450mm £90
SS.204S 600mm £100



S22 GLASS SHELF
Stainless steel
SS.402S
W: 300mm D: 80mm
£90



S22 DOUBLE ROBE HOOK
Stainless steel
SS.502S
£70



S22 TOWEL ARM 300MM SWIVEL
Stainless steel
SS.205S
£120



S22 GLASS SHELF
Stainless steel
SS.401S
W: 600mm D: 120mm
£130



S22 TRIPLE ROBE HOOK
Stainless steel
SS.503S
£90



S22 VANITY MIRROR
Stainless steel
SS.511S
£190

WASTES



**BASIN WASTE CLICK CLACK
SLOTTED ROUND**

WA.121C Chrome **£40**
WA.121B Brushed **£75**



**BASIN WASTE CLICK CLACK
SLOTTED SQUARE**

WA.131C Chrome **£45**



BASIN WASTE FLIP TOP SLOTTED

WA.141C Chrome **£20**



**BASIN WASTE CLICK CLACK
UNSLOTTED ROUND**

WA.122C Chrome **£40**
WA.122B Brushed **£75**



**BASIN WASTE CLICK CLACK
UNSLOTTED SQUARE**

WA.132C Chrome **£45**



**BASIN WASTE FLIP TOP
UNSLOTTED**

WA.142C Chrome **£20**



**BOTTLE TRAP ROUND 400MM
EXTENSION**

BT.121C Chrome **£50**
BT.121B Brushed **£135**



**BOTTLE TRAP SQUARE 400MM
EXTENSION**

BT.131C Chrome **£90**
BT.131B Brushed **£175**



**BASIN WASTE FREE FLOW
SLOTTED**

WA.151C Chrome **£30**

WASTES



BATH CLICK CLACK WASTE

Chrome
WA.171C Standard 80cm **£55**
WA.172C Extended 125cm **£65**



BATH SLIMLINE CLICK CLACK FILLER

Chrome
P: 32mm 1 bar HP
WA.191C Standard 80cm **£165**
WA.192C Extended 125cm **£185**



BATH SLIMLINE POP UP WASTE

WA.162C Chrome 125cm **£85**
WA.162B Brushed 125cm **£135**



BATH SLIMLINE POP UP FILLER

Brushed
P: 32mm 1 bar HP
WA.181B Standard 80cm **£225**
WA.182B Extended 105cm **£255**



BATH POP UP WASTE

WA.161C Chrome 80cm **£35**
WA.161B Brushed 80cm **£85**



BATH LEGS

Allows deck mounting of exposed
shower valves/bath shower mixers
BL.001C Chrome **£35**

TERMS & CONDITIONS

DEFINITIONS

In these conditions 'the Company' shall mean Arte Form Ltd, 'the purchaser' shall mean the person, firm or company to whom any quotation is addressed or with whom any contract is made and 'the goods' shall mean the goods and/or services agreed to be sold by the Company to the purchaser.

1. QUOTATION AND ACCEPTANCE

- (a) All quotations are given and all orders are accepted on these terms which shall apply to the exclusion of and shall override any other terms stipulated or referred to by the purchaser whether in its order or any other document, or in any negotiations or communication or course of dealing established between the Company and the purchaser;
- (b) No modification or amendment of these terms or addition thereto shall be effective unless made in writing and signed by a director of the Company.

2. DESCRIPTION OF AND STATEMENTS AS TO GOODS

- (a) Save where the goods are stated to be sold as complying with a recognised trade or industry standard, all descriptions, specifications, drawings and particulars of weights and dimensions submitted by the Company or otherwise contained in the Company's catalogues, brochures, price lists, quotations and publicity materials are approximate only and the Company shall not be liable for their accuracy unless they are expressly incorporated into the contract in writing;
- (b) These terms represent the entire agreement between the Company and the purchaser relating to the goods and such terms supersede and the purchaser shall not place any reliance upon any statements, recommendations and advice whether oral or in writing given (whether before or after the acceptance by the Company of the purchaser's order) by the Company, its servants or agents as to any matter relating to the goods save where such statement, recommendations or advice is given in writing and signed by a director of the Company in response to a specific written request from the purchaser before or at the time of the Company's acceptance of the order.

3. PRICES

Prices quoted by the Company are those in effect at the date of quotation. Unless otherwise agreed in writing, the Company reserves the right to increase prices when it accepts the purchaser's order so as to reflect one or more of the following:

- (a) any variation that may have occurred in the costs of labour, materials, suppliers overheads and transport;
- (b) any change in duty, tax, surcharge or levy of any kind whatsoever affecting the sale price of the goods;
- (c) any cost to the Company resulting from delay by the purchaser in giving to the Company information sufficient to enable it to supply the goods or provide the services or resulting from any alteration made at the request of the purchaser in the specification of the goods or in the place to which they are to be delivered or shipped;
- (d) any extra cost to the Company resulting from the goods being carried at the request of the purchaser by mode of transport more expensive than the Company's normal form of transport.

4. PAYMENT

- (a) Unless otherwise agreed in writing, the price for the goods will be due and payable on the last business day of the month following delivery;
- (b) The Company shall be entitled to charge interest on any part of the price which is not paid in accordance with clause (a) at the rate per annum of 3% above the Base Rate of HSBC Bank Plc from time to time;
- (c) Time of payment is of the essence and if the purchaser defaults in punctual payment of the price the Company shall be entitled to terminate the contract and recover the goods at the purchaser's expense without prejudice to any further rights which the Company may have;

- (d) Any default in payment of an invoice or an instalment payment on an invoice on the due date shall render the entire balance outstanding on all invoices from the Company to the purchaser immediately payable in full without demand being made notwithstanding any contrary provisions as to terms of payment in any one or all invoices;
- (e) If the purchaser fails to give all instructions reasonably required by the Company and all necessary document, licences, consents and authorities for forwarding the goods or is unable to accept delivery of the goods at the time when the goods are due and ready for despatch or delivery or shall otherwise cause or request delay, the purchaser shall pay to the Company all costs and expenses, including storage and insurance charges incurred or arising from such delay during which, at the Company's absolute discretion if its storage facilities permit, the goods will be stored at the purchaser's sole risk. This provision shall be in addition to and not in substitution for any other payment or damages for which the purchaser may be liable in respect of his failure to take delivery at the appropriate date;
- (f) The purchaser shall not be entitled to make any deduction from the price of goods which have been delivered to the purchaser in respect of any set off or counterclaim unless both the validity and the amount thereof have been expressly admitted in writing by the Company and such admission is signed by a director of the Company;
- (g) In the absence of any specific appropriation by the purchaser, the Company shall have the right to appropriate any payment made by the purchaser towards the satisfaction of any invoice outstanding from time to time as the Company shall in its absolute discretion think fit.

5. DELIVERY

- (a) Any time or date stated for delivery is given and intended as an estimate only and the Company shall not be liable for any loss or damage whatsoever resulting from any delay in delivery howsoever arising;
- (b) Unless otherwise stated in writing delivery shall be deemed to take place upon the occurrence of the first in time of the following, namely:
 - (i) the physical delivery of the goods to the purchaser at the Company's works;
 - (ii) the physical delivery of the goods to the purchaser's carrier or agent for the purpose of transmission to the purchaser or his nominee;
 - (iii) the physical delivery of the goods to the purchaser's place of business or such other place as he may direct by the Company, its carrier or agent, the purchaser being responsible for unloading;
- (c) Signature of the Company's delivery note by any employee, representative or agent of the purchaser shall be conclusive proof of delivery;
- (d) Where the contract provides for delivery by the Company, its carrier or agent:
 - (i) any claims for non-delivery must be made in writing to the Company within three days of receipt of invoice or advice note whichever is the earlier;
 - (ii) any claims in respect of goods damaged in transit or shortages in delivery must be made in writing to the Company within three days of delivery; shortages in delivery shall not give rise to a right to reject the goods delivered;
- (e) The Company shall be entitled to make partial deliveries or deliveries by instalments and all the provisions of these terms shall apply to such deliveries;

6. PROPERTY AND RISK

- (a) Risk in the goods shall pass to the purchaser at the time at which delivery takes place in accordance with clause 5 above and the purchaser shall be solely responsible for insuring the goods thereafter;
- (b) The Company shall retain ownership of and title in the goods delivered until full payment has been made in respect of all such goods. Until such time the goods shall be:
 - (i) stored separately from other goods in the possession of the purchaser;
 - (ii) marked or otherwise rendered identifiable as being the property of

- (c) the Company;
 - (iii) held by the purchaser as bailee of the Company;
 - (iv) held by the purchaser free from any charge, lien or other encumbrance;
- (c) Provided the Company has not requested their return and notwithstanding that payment in full has not been made for all of the goods delivered, the purchaser as principal and not as agent for the Company shall be entitled to use the goods or offer for sale and sell them in the ordinary course of his business;
- (d) Where the purchaser sells the goods prior to paying for them in full:
 - (i) the Company shall be legally and beneficially entitled to the proceeds of sale;
 - (ii) the purchaser shall hold the proceeds of sale on trust for the Company and shall not mingle them with other monies and shall not pay them into an overdrawn bank account;
 - (iii) he shall deposit the proceeds of sale in a separate bank account, the location and number of which he has previously notified to the Company, and he shall not be entitled to use or deal with the proceeds of sale until payment in full for the goods has been made to the Company;
- (e) The Company shall have the right at any time by its servants or agents to enter the purchaser's premises where the goods are stored, or are thought the Company to be stored, so as to:
 - (i) retake possession of the goods when the Company has requested their return and the purchaser has not immediately complied with the request, such retaking or return to be without prejudice to any other rights the Company may have arising therefrom;
 - (ii) inspect the storage of the Company's goods which have not been paid for in full;
 - (iii) investigate and ascertain whether all these terms are being complied with;

7. GUARANTEE AND LIABILITY

Arte Form Ltd products have a 15 year guarantee against manufacturing defects and 5 year guarantee on cartridges and hoses.

- (a) The Company guarantees all goods which have been manufactured by the Company against any defect of work or materials which can be proved to the Company's satisfaction to have been caused before delivery provided that:
 - (i) the goods are used for their normal purpose,
 - (ii) full details of any such defect are notified to the Company within thirty days of its first appearance and
 - (iii) the goods in which the defect arises are returned at the purchaser's expense to the Company; The above guarantee is given in lieu of and to the exclusion of all other warranties, conditions, representations and undertakings express or implied by statute or otherwise in respect of the quality or fitness for purpose of the goods or as to their condition or performance or as to any other matter except where such warranty or condition is implied by statute and by reason of a statutory provision, cannot be excluded;
- (b) Save as provided herein and save in any case where death or personal injury has been caused by the Company's negligence or any case where the Company is liable for a defect in the goods pursuant to Part 1 of the Consumer Protection Act 1987 or any statutory replacement thereof, the Company shall be under no liability whatsoever to the purchaser for any loss or damage whether direct, indirect or consequential arising out of any defect in, failure of or unsuitability for any purpose of the goods or any part thereof whether the same be due to any act, omission, breach of contract, negligence or wilful default in design, workmanship or materials or any other cause.

8. TERMINATION

The Company shall have the right forthwith to cancel the purchaser's order if any of the following events occur and subject to enforcement of the Company's rights to recover the goods and to receive payment of the price or damages, the contract shall be deemed to have terminated:

- (a) the purchaser commits any breach of its obligations to the Company;
- (b) any distress or execution is levied upon any property of the purchaser;
- (c) the purchaser makes or offers to make any arrangement or composition with creditors or commits any act of bankruptcy or insolvency;
- (d) any resolution is passed or petition presented to wind up the purchaser;
- (e) a receiver or administrator is appointed or any chargee takes possession of all or any part of the undertaking or assets of the purchaser;

- (f) the purchaser stops payment or ceases or threatens to cease to carry on its business or to pay its debts as and when they fall due;
- (g) any remittance for payment of the whole or any part of the purchase price of the goods is dishonoured by the purchaser's bankers.

9. ASSIGNMENT

The purchaser shall not assign or transfer or purport to assign or transfer any contract to which these terms apply to any other person without the Company's prior written consent. The Company reserves the right to subcontract the performance of the contract or any part of it.

10. FORCE MAJEURE

If the Company is prevented or delayed (directly or indirectly) from making delivery of the goods or any part thereof or from otherwise performing the contract or any part thereof by reason of war, embargo, riot, strike, lock-out, trade dispute, fire, breakdown of plant or machinery, inclement weather, interruption of transport, Government action, delay in delivery to the Company of any goods or materials, or by any cause whatsoever (whether or not of a like nature to the foregoing) outside its control, it shall be under no liability whatsoever to the purchaser and shall be entitled at its option either to cancel the contract or without any liability to extend the time or times for delivery by a period equivalent to that during which such delivery has been prevented.

11. RETURNS PROCEDURE

Note to retailers: We do not operate a sale or return policy. However, in the event that you need to return products to us for any reason the following procedure should help to ensure that we handle your request efficiently.

Please note goods which are no longer required and that have been held by you for longer than three months from date of invoice cannot be considered for return and credit. A Collection Note should be emailed to our Collections Department:

- e-mail: collections@arteform.co.uk

We require the following details in order to process the necessary paperwork: Item stock code, finish & quantity of item(s) to be returned, the relevant Invoice Number or Delivery Note Number and the reason for return of the item(s). Our Collections Department will process the paperwork and after the collection request has been authorised, we will aim to collect the item(s) within 5 working days. You will also receive a Returned Goods Authorisation Note. The details of this note need to be checked and signed by you. If you have any queries whatsoever regarding the collection, please telephone our Collections Department.

All goods are to be suitably packaged before return to Arte Form Ltd, i.e. presentation boxes packed inside an outer box. Goods received back in anything other than re-saleable condition, may result in a request for credit being refused.

With the exception of faulty or damaged goods, all goods being returned will be subject to a 25% re-stocking charge with a minimum £15 charge being applicable. If items are received damaged or faulty no charge is made for returning the goods to us. Please note: shortages and damages must be notified within 2 days of receipt of goods.

Notification outside of the 2-day period will void any claim. If, after our inspection, a product is found to be defective due to a manufacturing fault we will issue a credit or a free of charge replacement.

Our collections department will liaise with your designated contact, confirming the total number of boxes packed ready for collection and a mutually convenient collection date will be arranged.

12. CLAIMS FOR REFIXING

In the event that you have a claim for re-fitting or repair of a faulty product, please contact our Technical department on 01223 828747. All claims for re-fixing charges must be authorised by us before any work is undertaken. Claims for re-fixing that are made after work has been undertaken will be rejected.

PROPER LAW

The contract and these terms shall be governed by English law and the purchaser shall submit to the sole jurisdiction of the English Courts.

