

# 121 & 126 automatic balancing valves

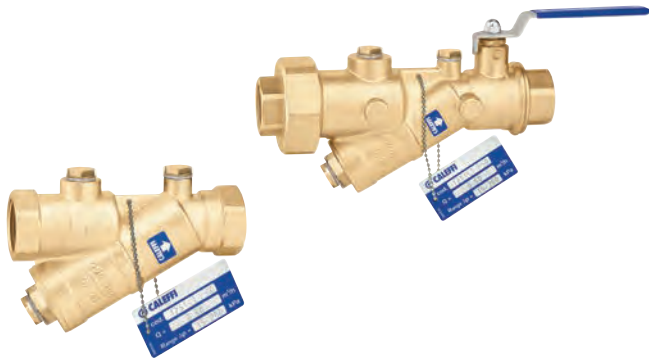

# 121 & 126 automatic balancing valves



## Introduction

The Altecnic automatic balancing valves (ABVs) are used to keep the flow rate constant, at the design value, in air conditioning and heating system.

They automatically balance the circuit by ensuring the design flow rate to each terminal unit irrespective of changes elsewhere in the system.

Altecnic automatic balancing valves are available both as a flow regulator or complete with a ball shut-off valve.

## Product Range

- 121 Automatic balancing valve with high resistance polymer cartridge and ball valve.
- 126 Automatic balancing valve with high resistance polymer cartridge.

## Materials

Component	Material	Grade
Body	DZR	BS EN 12165 CW602N
Spring:	Stainless steel	BS EN 10270-3 (AISI 302)
Seals:	EPDM	
Pressure port plugs:	DZR	BS EN 12164 CW602N
Cartridge:		
1/2" to 1 1/4"	High resistance polymer	
1 1/2" & 2"	Stainless steel and high resistance polymer	

## 121 Only

Ball:	Brass Chrome plated	BS EN 12165 CW614N
Ball seat:	PTFE	
Stem seal:	PTFE	
Lever:	Steel - zinc plated	

## Technical Specification

Medium:	Water glycol solution
Max. percentage glycol:	50%
Max. working pressure:	25 bar
Max. temperature range:	-20 to 100 °C
Δp range:	15 to 200 kPa
Flow range:	0.085 to 11.0 m <sup>3</sup> /h 0.024 to 3.055 l/s
Accuracy:	±10%

## Connections

Pressure test ports - female:	1/4" BS EN ISO 228
Main - female:	BS EN 10226-2

## Dimensions

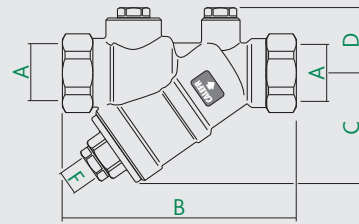

Code	A	B	C	D	F	kg
126141	Rc1/2	101	52.5	30	1/4"	0.55
126151	Rc3/4	106	52.5	30	1/4"	0.58
126161	Rc1	140.5	102	33.5	1/2"	1.02
126171	Rc1 1/4	148	102	33.5	1/2"	1.06
126181	Rc1 1/2	177	105	38.5	1/2"	2.25
126191	Rc2	176	105	38.5	1/2"	2.45

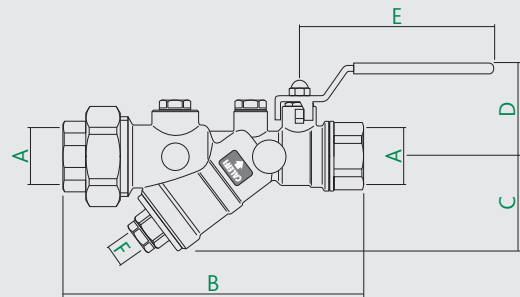

Code	A	B	C	D	E	F	kg
121141	Rc1/2	156.5	52.5	50	100	1/4"	1.1
121151	Rc3/4	159.5	52.5	50	100	1/4"	1.1
121161	Rc1	218.5	68	66	120	1/2"	2.3
121171	Rc1 1/4	220.5	68	66	120	1/2"	2.3
121181	Rc1 1/2	253	84	88	140	1/2"	4.6
121191	Rc2	253	84	88	140	1/2"	4.6

# 121 & 126 automatic balancing valves

## Circuit Balancing

Modern heating and air-conditioning systems have to guarantee a high level of thermal comfort with a low energy consumption.

This means supplying the terminal emitters with the correct design flow rates, to produce balanced hydraulic circuits.

## Unbalanced Circuits

In case of an unbalanced circuit, the hydraulic imbalance between emitters creates areas with temperatures which are not uniform, and, as a consequence, problems with thermal comfort and higher energy consumption.

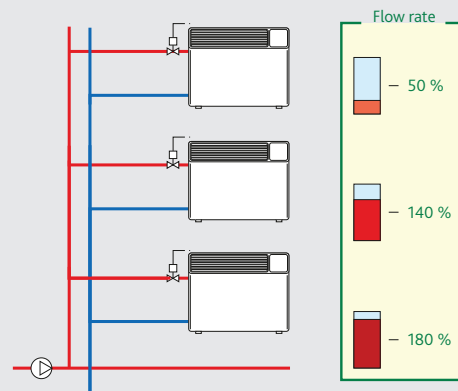
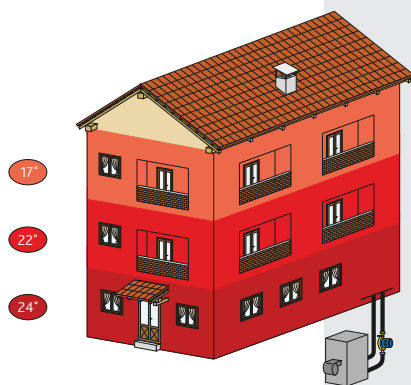

## Circuits Balanced by Manual Valves

Traditionally, circuits are balanced using manual balancing valves.

With manual balancing valves, the circuits are only balanced at full load conditions and any changes within the circuits can affect the balance and flow rate to individual circuits to a greater or lesser degree.

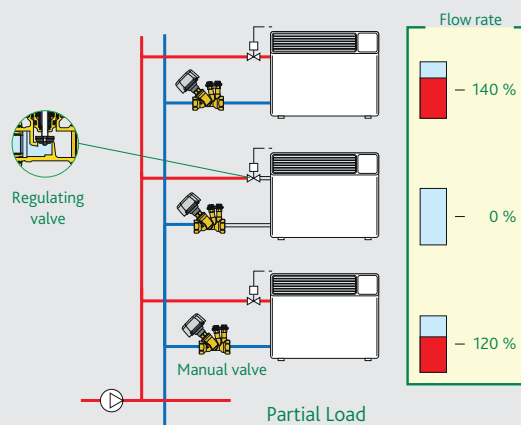
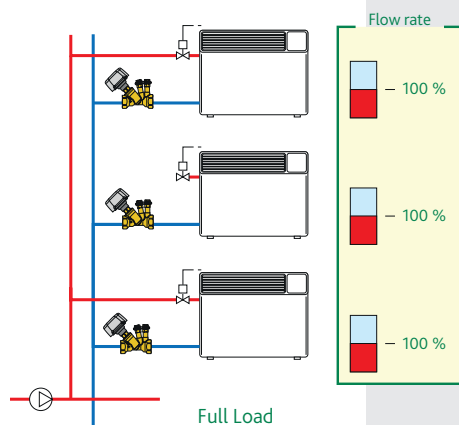

## Circuits Balanced by Automatic Balancing Valves

ABVs balance the circuit automatically, by ensuring each terminal emits the design flow rate.

Even in the case of partial circuit closure by means of the regulating valves, the flow rates in the open circuits remain constant at the designated value.

The system always maintains the greatest comfort and energy savings.

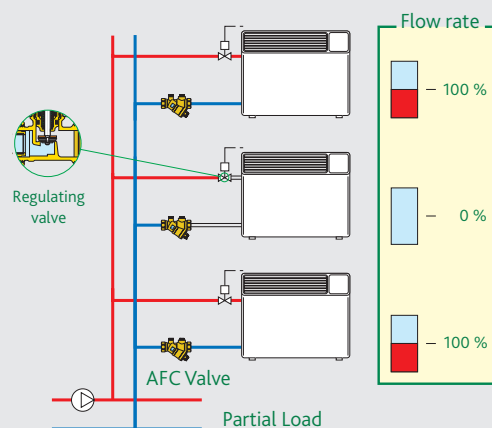
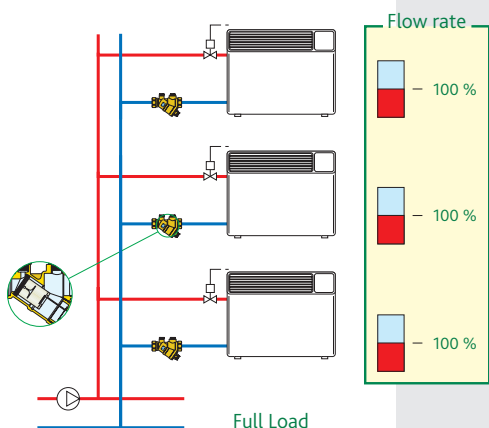

# 121 & 126 automatic balancing valves

## Function

The Altecnic automatic balancing valve is intended to maintain a constant flow rate when the upstream differential pressure varies.

It is therefore necessary to refer to the  $\Delta p$  - flow rate diagram and to a basic diagram illustrating the operating methods and the relevant variable effects.

## Operating principle

The regulating element of these devices is composed of a cylinder and a piston with fixed and variable geometry orifices, through which the fluid flows. The surface area of these orifices is governed by the piston movement when pushed by the flow. A specially calibrated spring counteracts this movement.

Altecnic automatic balancing valves are high performance automatic regulators. They regulate selected flow rates within a very tight tolerance (approx. 5%) and offer a wide range of operation.

### Below the Control Range

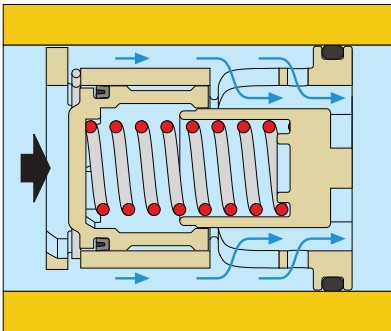

In this case, the regulating piston remains fully out without compressing the spring and gives the medium the maximum free flow area.

In practice, the piston acts as a fixed orifice and thus the flow through the ABVs depends solely on the differential pressure.

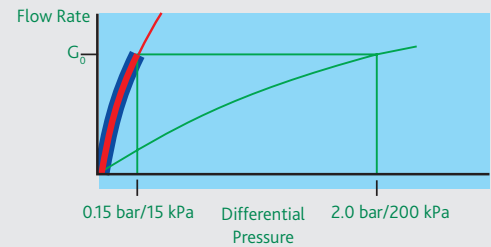
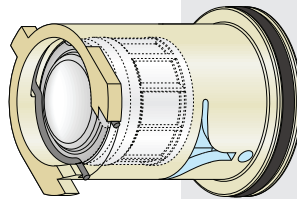

$$Kv_{0,01} = 0.258 \times G_0 \Delta p \text{ range } 15 - 200 \text{ kPa} \text{ where } G_0 = \text{design flow rate}$$

### Within the Control Range

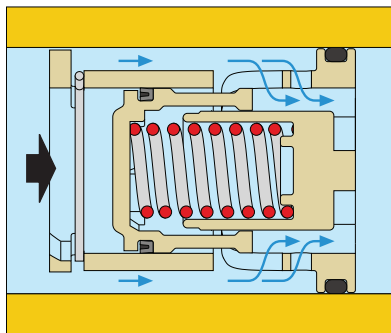

If the differential pressure is within the control range, the piston compresses the spring and gives the medium a free flow area to permit the designated flow to pass.

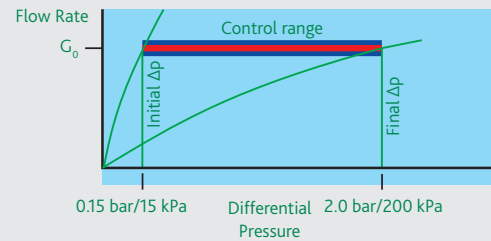
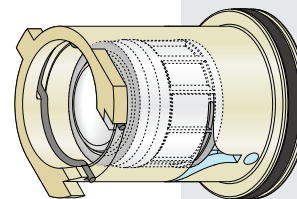

### Above the Control Range

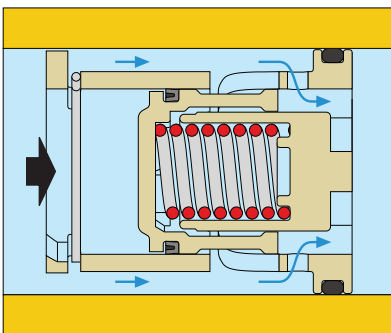

In this case, the piston is fully compressed and only allows flow through the fixed orifice.

The flow rate through the ABV thus depends solely on the differential pressure.

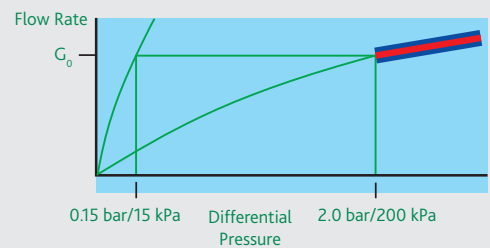
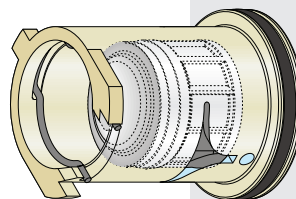

$$Kv_{0,01} = 0.070 \times G_0 \Delta p \text{ range } 115 - 200 \text{ kPa} \text{ where } G_0 = \text{design flow rate}$$

# 121 & 126 automatic balancing valves

## Control range or $\Delta p$ range of the Automatic Balancing Valve

By definition, the control range is contained between two differential pressure values:

$$\text{range } \Delta p: \Delta p_{\text{flow}} - \Delta p_{\text{return}}$$

The choice must be made taking into account the following:

- **differential pressure at the start of the control range.** This value must be added to the fixed loss of head in the circuit in the most unfavourable conditions. In this case it is necessary to evaluate the available pump head.
- **differential pressure at the end of the control range.** If this value is exceeded the cartridge spring is fully compressed and the device no longer performs any regulating action. It will be necessary to switch to a higher control range.

The following control range is available.

15- 200 kPa Can be used in the majority of sealed systems.

0.15 - 2.0 bar The ample control range allows it to be inserted with a minimum additional differential pressure, amounting to 15 kPa.

## Sizing the Circuit with Automatic Balancing Valves (ABVs)

Sizing the circuit containing automatic balancing valves is particularly easy to accomplish.

As illustrated alongside by the example diagrams, calculation of the loss of head in order to choose the pump is made by referring to the most unfavourable circuit and by adding this value to the minimum differential pressure required by the ABV.

In the example the circuits have the same nominal flow rate.

The ABV, located on intermediate circuits, automatically absorb the excess differential pressure to ensure the corresponding nominal flow rate.

As the regulating valves open or close, the cartridge repositions itself dynamically to maintain the nominal flow rate (50% load = circuits 3, 5, 7, 8 closed).

For more detailed information on sizing a system with Altecnic Automatic Balancing valves, please refer to the Altecnic Technical Department.

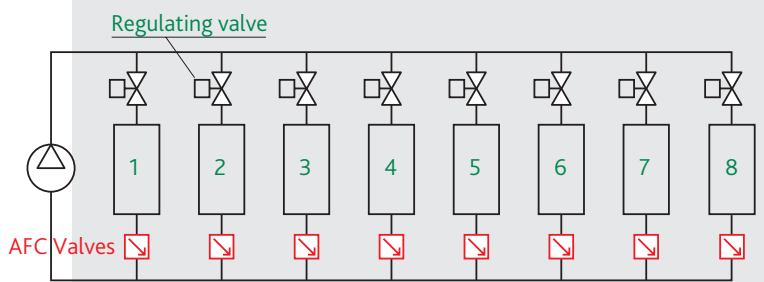

### Differential pressures ( $\Delta p$ )

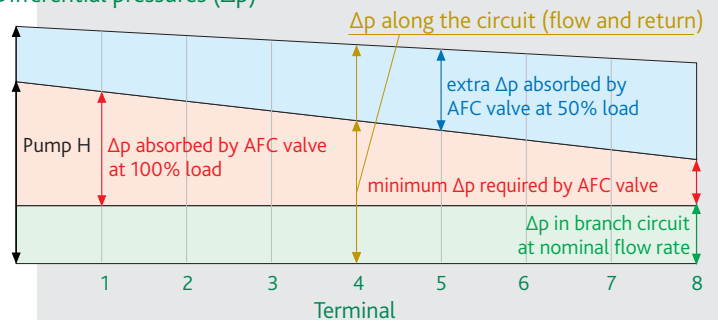

## Construction Details

### Polymer cartridge

The flow cartridge is made entirely of high resistance polymer, suitable for use in air conditioning and heating systems.

The polymer maintains its mechanical properties over a wide range of temperatures.

It also has a high resistance to abrasion due to the continuously flow liquid and minimises the deposition of scale.

It is fully compatible with glycols and other additives used in these systems.

### Wide range of working pressures

The flow cartridge provide precise regulation of the flow rate over a wide range of working pressures. It is factory calibrated to keep the flow rate within  $\pm 5\%$  of the set value.

The design of the internal chamber acts as a damper to the vibration caused by the flowing liquid reducing noise.

For these reasons it can be used in system circuits both as branch valves and directly at the terminal emitters.

### Ball valve

The control stem of the ball valve is blow-proof and the reversible closing lever is covered with vinyl.

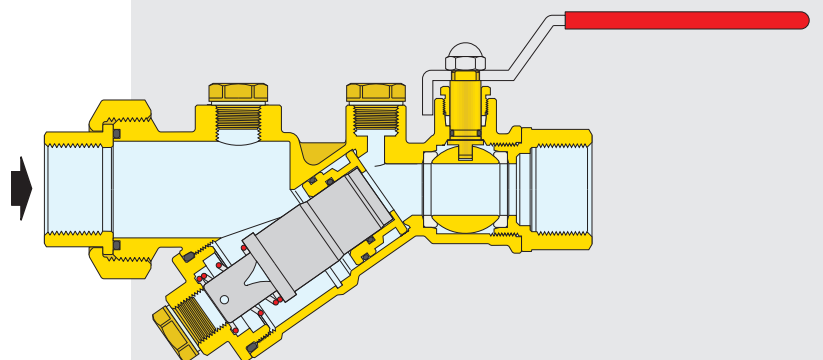

# 121 & 126 automatic balancing valves

## Replaceable cartridge

The flow cartridge is a complete assembly so as to permit easy removal from the body for inspection or replacement.

The cartridge is retained in the body by a wire clip and retaining ring for fast and safe positioning without the need for tools.

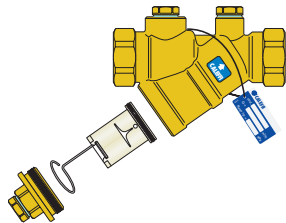

## Flow Rate Table for 121 Series

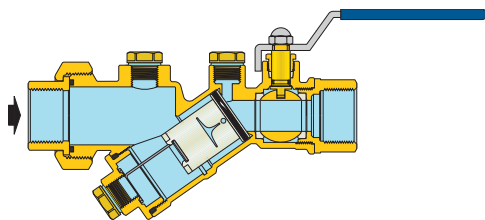

Code	Kv (m <sup>3</sup> /h)	Min Working Δp (kPa)	Δp Range (kPa)	Flow rate (m <sup>3</sup> /h)
121141...	6.90	15	15 to 200	0.085, 0.12, 0.15, 0.2, 0.25, 0.3, 0.35, 0.4, 0.5, 0.6, 0.7, 0.8, 0.9, 1.0, 1.2
121151...	7.73	15	15 to 200	0.085, 0.12, 0.15, 0.2, 0.25, 0.3, 0.35, 0.4, 0.5, 0.6, 0.7, 0.8, 0.9, 1.0, 1.2, 1.4, 1.6
121161...	18.00	15	15 to 200	0.5, 0.6, 0.7, 0.8, 0.9, 1.0, 1.2, 1.4, 1.6, 1.8, 2.0, 2.25, 2.5, 2.75, 3.0, 3.25, 3.5, 3.75, 4.0, 4.25, 4.5, 4.75, 5.0
121171...	18.50	15	15 to 200	0.5, 0.6, 0.7, 0.8, 0.9, 1.0, 1.2, 1.4, 1.6, 1.8, 2.0, 2.25, 2.5, 2.75, 3.0, 3.25, 3.5, 3.75, 4.0, 4.25, 4.5, 4.75, 5.0
121181...	47.24	15	15 to 200	5.5, 6.0, 6.5, 7.0, 7.5, 8.0, 8.5, 9.0, 9.5, 10.0, 11.0
121191...	48.89	15	15 to 200	5.5, 6.0, 6.5, 7.0, 7.5, 8.0, 8.5, 9.0, 9.5, 10.0, 11.0

## Flow Rate Table for 126 Series

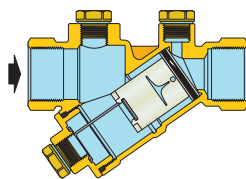

Code	Kv (m <sup>3</sup> /h)	Min Working Δp (kPa)	Δp Range (kPa)	Flow rate (m <sup>3</sup> /h)
126141...	6.69	15	15 to 200	0.085, 0.12, 0.15, 0.2, 0.25, 0.3, 0.35, 0.4, 0.5, 0.6, 0.7, 0.8, 0.9, 1.0, 1.2
126151...	7.58	15	15 to 200	0.085, 0.12, 0.15, 0.2, 0.25, 0.3, 0.35, 0.4, 0.5, 0.6, 0.7, 0.8, 0.9, 1.0, 1.2, 1.4, 1.6
126161...	14.00	15	15 to 200	0.5, 0.6, 0.7, 0.8, 0.9, 1.0, 1.2, 1.4, 1.6, 1.8, 2.0, 2.25, 2.5, 2.75, 3.0, 3.25, 3.5, 3.75, 4.0, 4.25, 4.5, 4.75, 5.0
126171...	14.50	15	15 to 200	0.5, 0.6, 0.7, 0.8, 0.9, 1.0, 1.2, 1.4, 1.6, 1.8, 2.0, 2.25, 2.5, 2.75, 3.0, 3.25, 3.5, 3.75, 4.0, 4.25, 4.5, 4.75, 5.0
126181...	34.72	15	15 to 200	5.5, 6.0, 6.5, 7.0, 7.5, 8.0, 8.5, 9.0, 9.5, 10.0, 11.0
126191...	37.88	15	15 to 200	5.5, 6.0, 6.5, 7.0, 7.5, 8.0, 8.5, 9.0, 9.5, 10.0, 11.0

# 121 & 126 automatic balancing valves

## Coding for ABV Cartridges

For correct identification of the 121 and 126 valves including the cartridge the code must be in the following order;

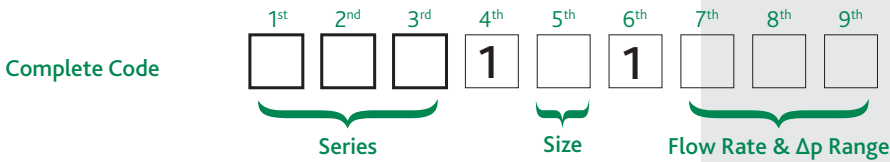

Series

1 <sup>st</sup>	2 <sup>nd</sup>	3 <sup>rd</sup>	The first three digits indicate the series
-----------------	-----------------	-----------------	--

121	Automatic balancing valve with ball valve
126	Automatic balancing valve

Size

5 <sup>th</sup>	The fifth digit indicate the size
-----------------	-----------------------------------

Size	1/2"	3/4"	1"	1 1/4"	1 1/2"	2"
Digit	4	5	6	7	8	9

Flow Rate & Δp Range

7 <sup>th</sup>	8 <sup>th</sup>	9 <sup>th</sup>	The last three digits indicate the flow rates available
-----------------	-----------------	-----------------	---

with Δp range 15–200 kPa									
m <sup>3</sup> /h	digit	m <sup>3</sup> /h	digit	m <sup>3</sup> /h	digit	m <sup>3</sup> /h	digit	m <sup>3</sup> /h	digit
0.085	M08	0.40	M40	1.20	1M2	2.75	2M7	4.50	4M5
0.12	M12	0.50	M50	1.40	1M4	3.00	3M0	4.75	4M7
0.15	M15	0.60	M60	1.60	1M6	3.25	3M2	5.00	5M0
0.20	M20	0.70	M70	1.80	1M8	3.50	3M5	5.50	5M5
0.25	M25	0.80	M80	2.00	2M0	3.75	3M7	6.00	6M0
0.30	M30	0.90	M90	2.25	2M2	4.00	4M0	6.50	6M5
0.35	M35	1.00	1M0	2.50	2M5	4.25	4M2	7.00	7M0
								7.50	7M5
								8.00	8M0
								8.50	8M5
								9.00	9M0
								9.50	9M5
								10.0	10M
								11.0	11M

## Notes:

### Installation of Automatic Balancing Valve

In air-conditioning systems, ABVs must be installed on the circuit return pipe - see typical installation examples.

### Sizing the system with Automatic Balancing Valve

For more detailed information on sizing a system with ABVs, please refer to the 2nd volume of the Altecnic Handbook and the technical bulletin "Dynamic balancing of hydronic circuits". This gives theoretical calculations, numerical examples and notes on the application of the above-mentioned devices in circuits.

### Medium

ABVs can be used with fluids other than water. In this case it is recommended to contact our Technical Department to select the most suitable product.

# 121 & 126 automatic balancing valves

## Typical Application for ABVs

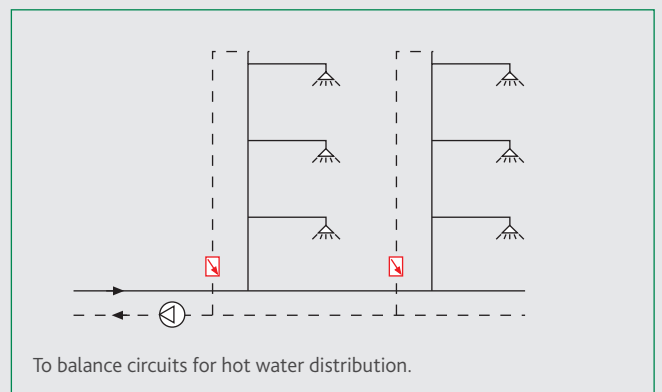
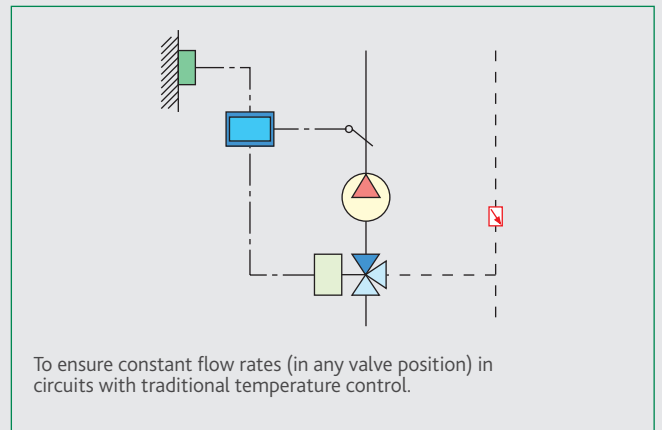
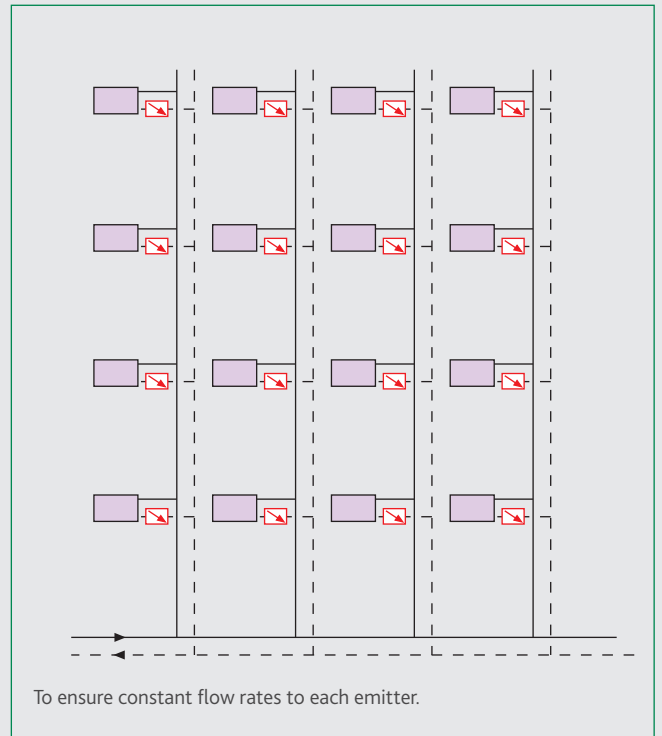
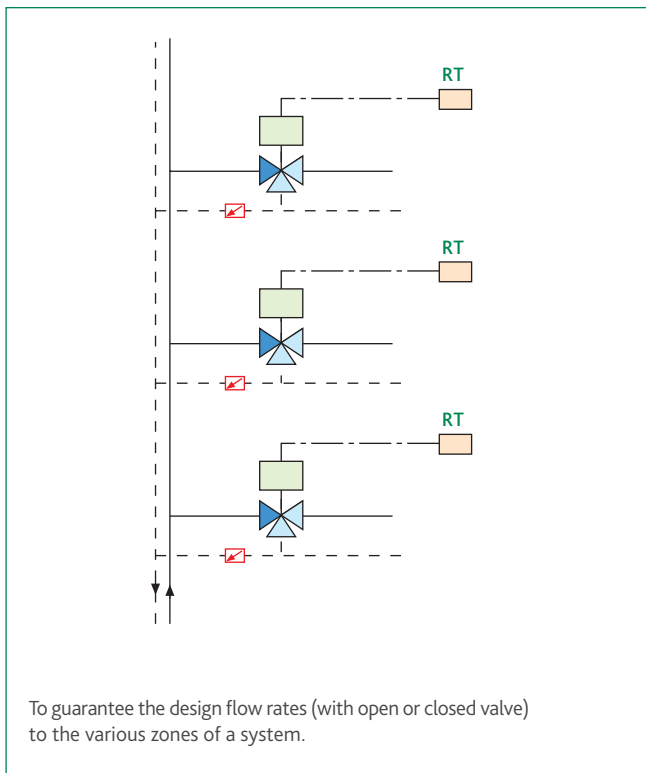
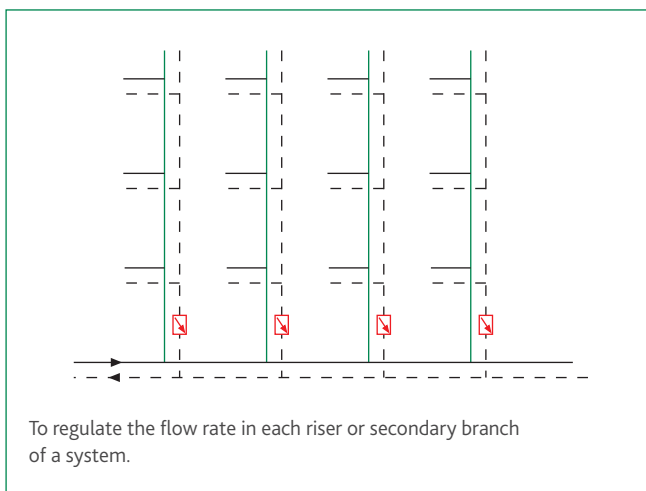
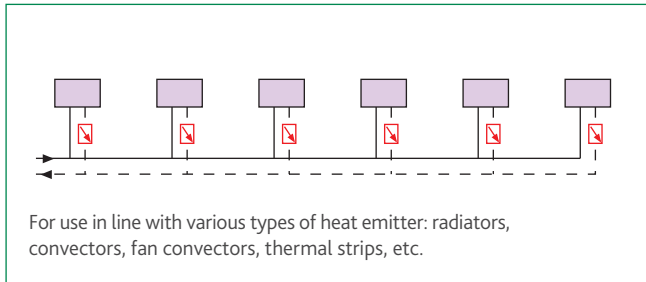

# 121 & 126 automatic balancing valves

## Typical Application for ABVs

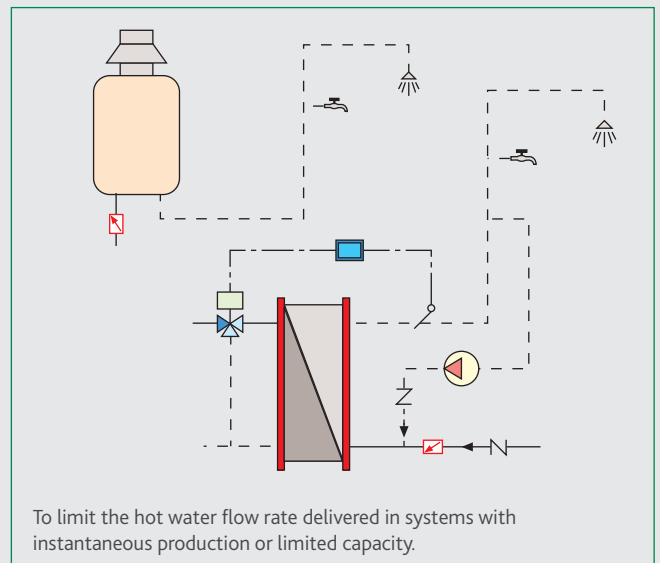
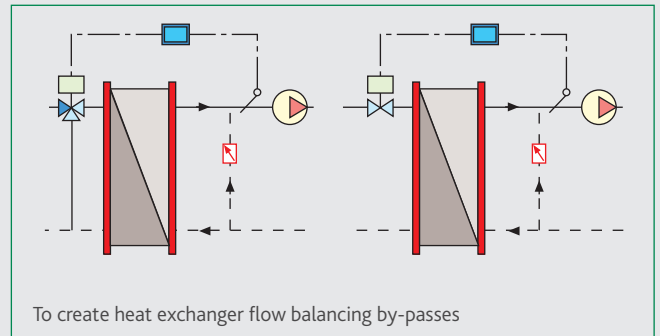
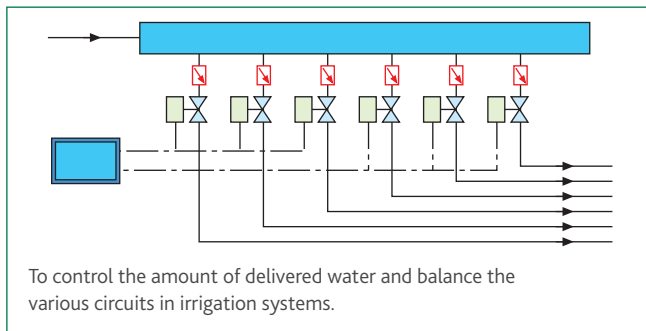
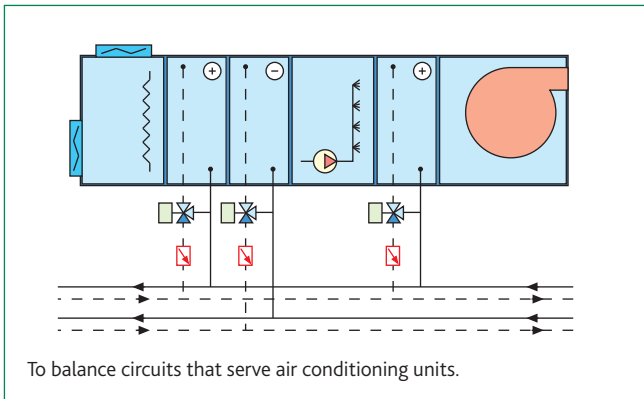

### Typical Applications

To Balance heating and chilled water systems.

To limit the flow rate delivered to each user in district heating systems.

Suitable for industrial applications requiring water/solution to be delivered in a designated quantity.

# 121 & 126 automatic balancing valves

## Minimum differential pressure

Minimum differential pressure is the sum of two values;  
The minimum working pressure of the ABV cartridge.  
The  $\Delta p$  created by the design flow rate through the body only  
This can be calculated using  $k_{v0,01}$ .

### Example

126 ABV 1" size with flow rate  $G_0 = 1200$  l/h,  $\Delta p$  range 15-200 kPa.

$$\Delta p_{\text{required}} = \Delta p_{\text{Cartridge}} + \Delta p_{\text{Body}} = 15 + (G_0/k_{v0,01})^2 = 15 + (1200/1400)^2 = 15.7 \text{ kPa}$$

$$\text{Pump head } H = \Delta p_{\text{circuit}} + \Delta p_{\text{required}}$$

## Checking the Flow Rate using the Pressure Ports

It is sufficient to check the differential pressure from upstream to downstream, using the pressure provided ports (1) - (2).

If the differential pressure is contained within the control range (range  $\Delta p$ ) indicated on the data plate, then the flow rate is equal to the nominal value.

To take the measurement, simply use a differential pressure gauge. Snap-on pressure test ports 100 series and electronic measuring station 130 series can be used as accessories.

## Drain Valve

The cover (3) contains a connection which can be used to fit a drain valve.

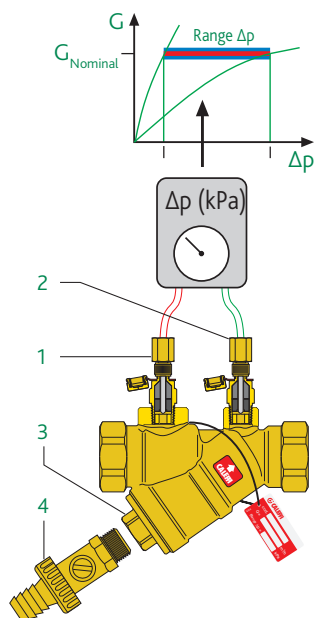

## Electronic Manometer - 130



Electronic flow rate and differential pressure measuring station. Supplied complete with shut-off valves and connection fittings. May be used for  $\Delta p$  measurements and setting of balancing valves. Bluetooth® transmission between  $\Delta p$  measuring station and remote control unit.

Versions complete with remote control unit with Windows Mobile® or with Android® application for Smartphone and Tablet.

### Code

130006 - complete with remote control unit, with Android® application.

130005 - without remote unit, with Android® application.

## Pressure Test Points - 100



Pair of pressure/temperature points. Brass body. EPDM seals. Max. working pressure: 30 bar. Working temperature range: -5 to 130°C. Connections: 1/4" M.

## Drain Valve - 538



Drain cock with hose connection. Connections sizes 1/4" and 1/2". Max. working pressure: 10 bar. Max. working temperature: 110°C