

Alifabs Architectural Coping for buildings of any height

TYPICAL ARCHITECTURAL COPING SECTION

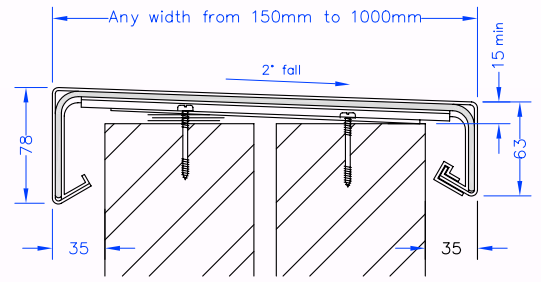

TYPICAL CLICKFIX COPING SECTION

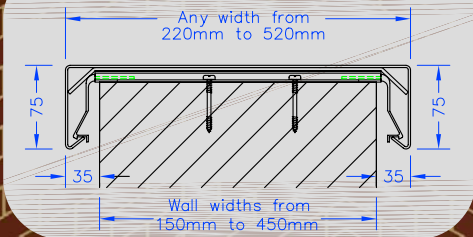

Alifabs ClickFix Coping for buildings upto 4 storeys

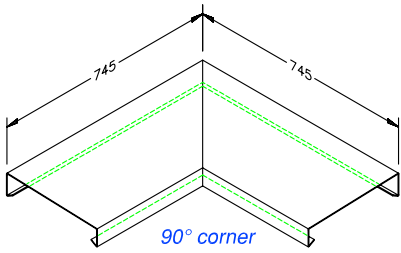

90° corner

Irregular Corner (other than 90° or different widths)

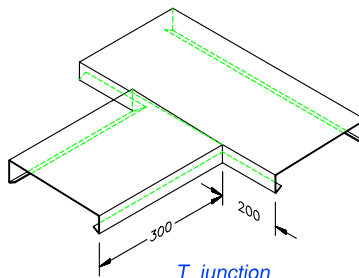

T junction

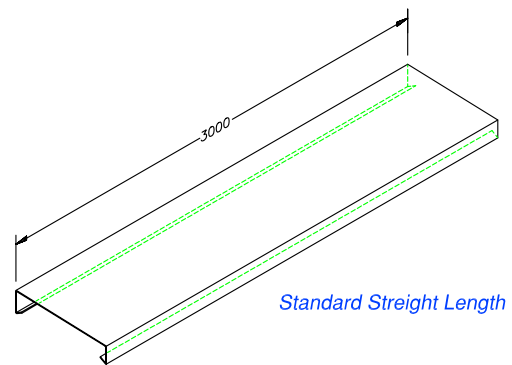

Standard Straight Length

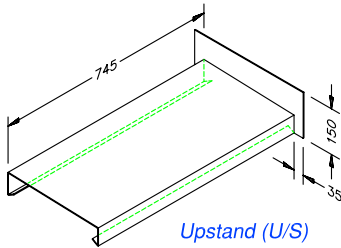

Upstand (U/S)

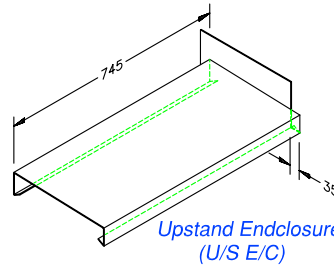

Upstand Enclosure (U/S E/C)

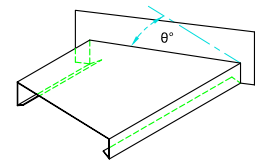

Angled Upstand

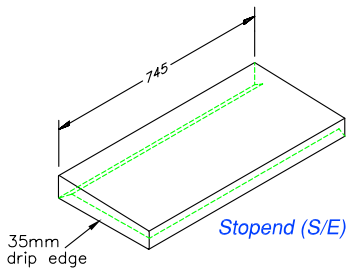

Stopend (S/E)

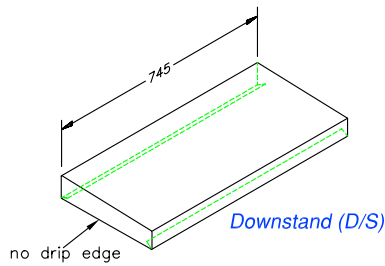

Downstand (D/S)

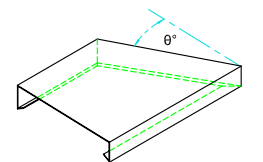

Angled Stopend

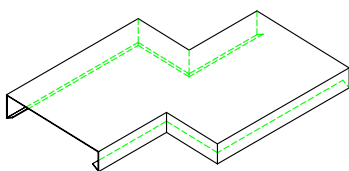

Zed Section

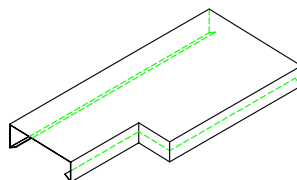

Reduction

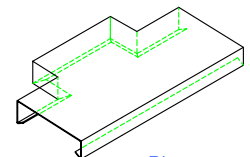

Pier