

AEROCEILING®

SUSPENDED CEILING & WALL FRAMES

by





AEROFit

Pages 4-13

- Small & Medium Ceiling Clouds
- Large Ceiling Clouds
- Wall Frames
- Partitions



AEROCustom

Pages 14-15

- Custom Shapes
- Custom Prints



AEROLight

Pages 16-17

- Lighting Solutions



AEROSilent

Page 18

- Acoustic Solutions



AEROAccess

Page 19

- Removable Panels

Infinite Possibilities

AEROCEILING® is a suspended frame system that can dramatically transform a space. Used for decorative, acoustic or backlighting purposes, clouds are the ultimate design expression. Our technical services team can help turn your imagination into reality.



Shapes



Translucent



Backlit



Color



Print



Acoustic

Features

AEROCEILING systems are 100% customizable. They can adapt to any design specifications and shapes in conjunction with the appropriate CLIPSO® profiles. AEROCEILING frames can be designed to incorporate acoustic and/or backlighting solutions. You can also create your own look with our custom printing services.

Benefits

- Provides an attractive acoustic solution
- 100% customizable
- Integrated lighting
- Easy installation process
- Suitable for walls, ceilings and partitions
- Wide selection of sizes, from small to large surfaces
- Custom print capabilities
- Access to plenum





Small & Medium Ceiling Clouds up to 8' x 11'

Ceiling clouds fit your aesthetic and/or acoustical needs with their durability, elegant appearance and strong, sound-absorbing performance. Their noise reduction and reverberation control can help with any acoustical issue. Clouds can be used as lightboxes for design purposes or can be used as the main light source for a room. They can be suspended parallel to the ceiling or at any other angle, thus significantly increasing the sound-absorptive surface area of each panel. CLIPSO® will help you create stunning architectural features and elegant designs with ceiling clouds.



Standard Ceiling Clouds



Small Ceiling Frame

Item number: CDA25

Type of use: Aluminum profile for self-supporting frame. Single fabric layer.

Available finishes: White, black, anodized, untreated or custom color aluminum (with surcharge)

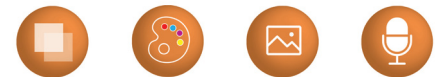
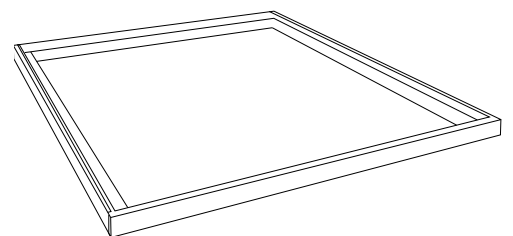
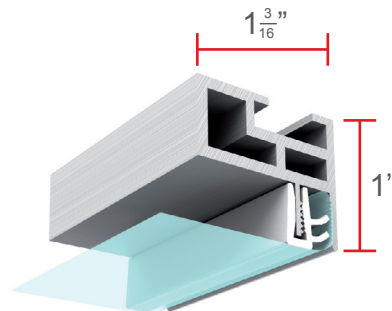

Medium Ceiling Frame

Item number: CDA35

Type of use: Aluminum profile for self-supporting frame. Single fabric layer.

Available finishes: White, black, anodized, untreated or custom color aluminum (with surcharge)

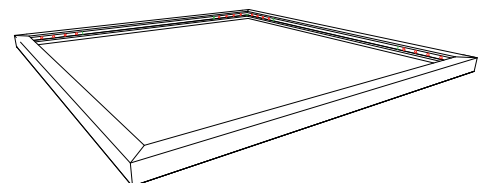
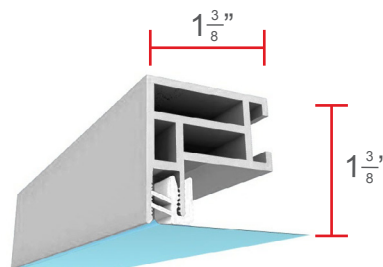

Acoustic Ceiling Clouds



Flat Frame

Item number: CPA67

Type of use: Aluminum profile for self-supporting frame. Single or double fabric layer.

Available finishes: White, black, anodized, untreated or custom color aluminum (with surcharge)

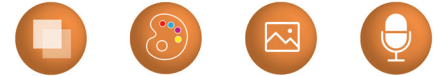
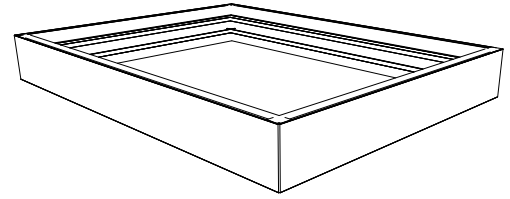
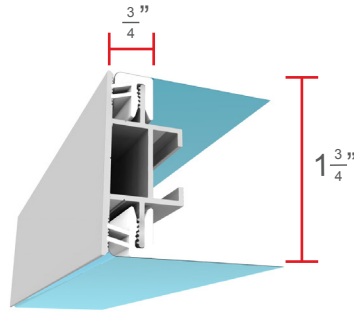

Round Frame

Item number: CRA68

Type of use: Aluminum profile for self-supporting frame. Single or double fabric layer.

Available finishes: White, black, anodized, untreated or custom color aluminum (with surcharge)

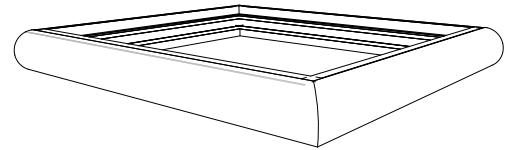
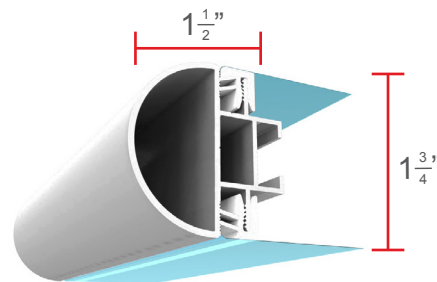



Large Ceiling Clouds

Ceiling clouds are 100% customizable and sized to fit your needs. They may be backlit for aesthetic purposes or acoustic for noise reduction and reverberation control, which is beneficial for very large spaces. A large ceiling cloud, when backlit, is the perfect solution for adding drama to a large space such as airports, concert venues, museums, lobbies, etc. The ceiling cloud in the photo below measures 16 ft x 90 ft.



Standard and/or Acoustic Ceiling Clouds

5 1/2" Frame

Item number: CAC140

Type of use: Aluminum profile for self-supporting frame.

Single or double fabric layer.

Available finishes: White, black, anodized, untreated or custom color aluminum (with surcharge)

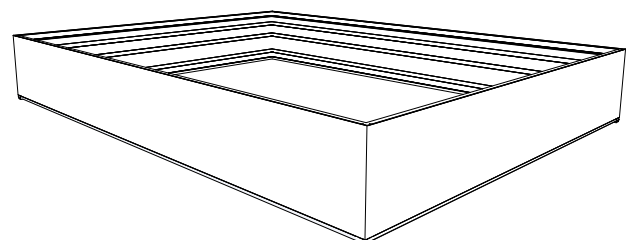
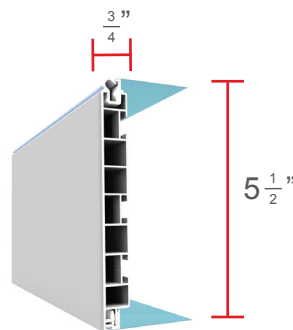

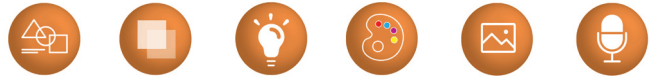

4" Frame

Item number: CAC100

Type of use: Aluminum profile for self-supporting frame.

Single or double fabric layer.

Available finishes: White, black, anodized, untreated or custom color aluminum (with surcharge)

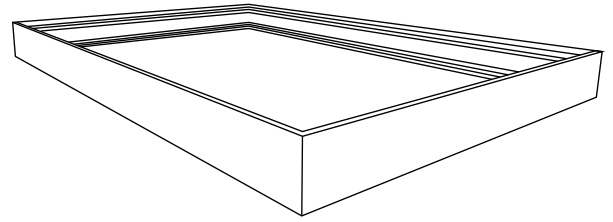
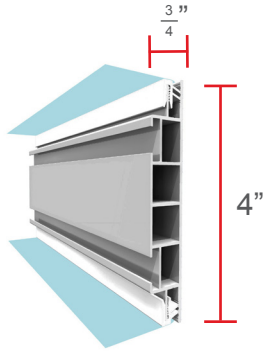



Backlit and/or Acoustic Ceiling Clouds



Backlit Ceiling Clouds

2" Frame

Item number: CDA50
Type of use: Aluminum profile for self-supporting frame. Single or double fabric layer.
Available finishes: White, untreated or custom color aluminum (with surcharge)

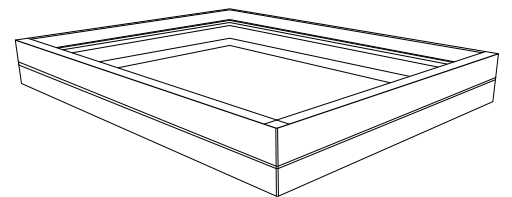
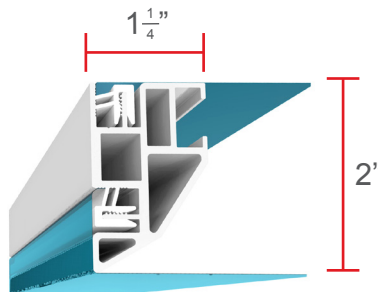

3" Frame

Item number: CDA75
Type of use: Aluminum profile for self-supporting frame. Single or double fabric layer.
Available finishes: White, black, anodized, untreated or custom color aluminum (with surcharge)

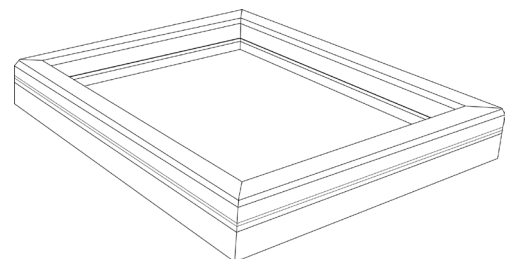
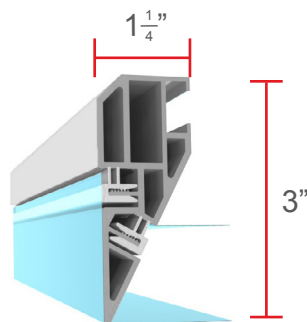

Backlit and/or Acoustic Ceiling Clouds

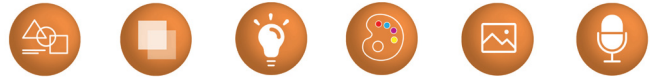

4" Frame

Item number: CAC100

Type of use: Aluminum profile for self-supporting frame.

Single or double fabric layer.

Available finishes: White, black, anodized, untreated or custom color aluminum (with surcharge)

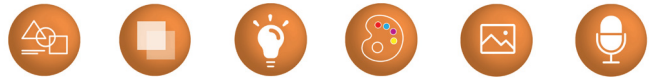
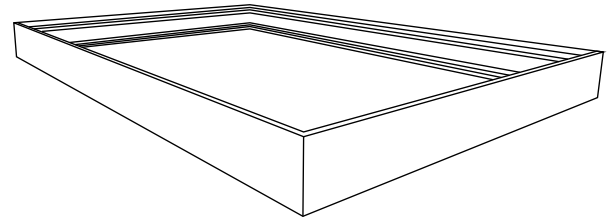
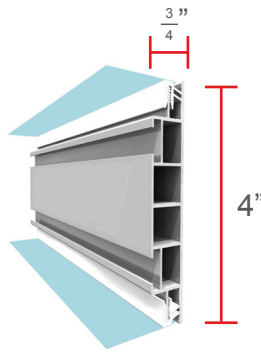

5 1/2" Frame

Item number: CAC140

Type of use: Aluminum profile for self-supporting frame.

Single or double fabric layer.

Available finishes: White, black, anodized, untreated or custom color aluminum (with surcharge)

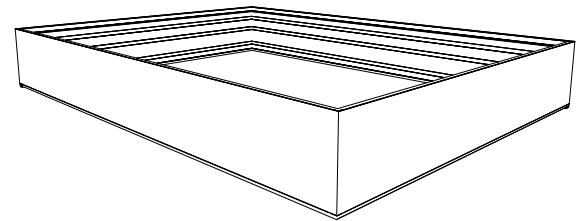
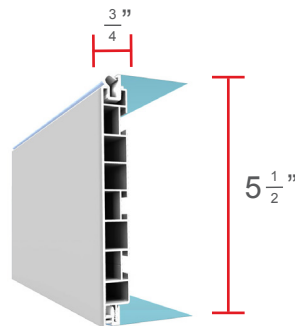



Wall Frames

Wall frames are an easy way to incorporate graphics and color into your interior design. They can be functional by providing acoustic control or can be backlit for aesthetic purposes. To keep your interior updated, the fabric can be changed with ease.



Small Wall Frames



Flat Frame

Item number: CEP18

Type of use: Aluminum profile for self-supporting frame.

Single fabric layer.

Available finishes: White, black, anodized, untreated or custom color aluminum (with surcharge)

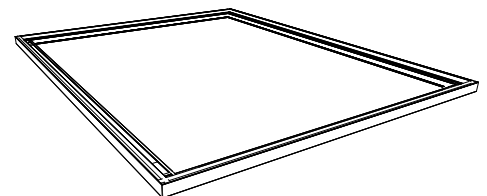
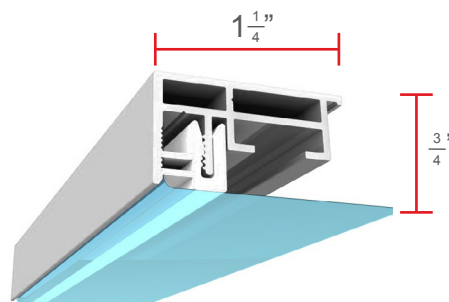

Medium Wall Frames



Flat Frame

Item number: CPA67

Type of use: Aluminum profile for self-supporting frame.

Single or double fabric layer.

Available finishes: White, black, anodized, untreated or custom color aluminum (with surcharge)

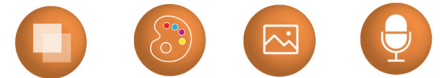
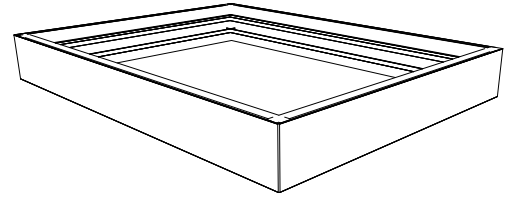
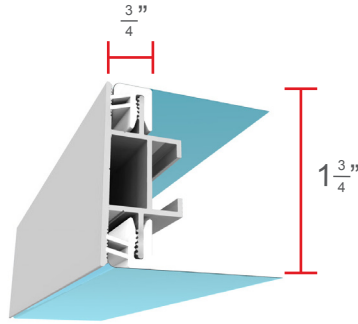

Round Frame

Item number: CRA68

Type of use: Aluminum profile for self-supporting frame.

Single or double fabric layer.

Available finishes: White, black, anodized, untreated or custom color aluminum (with surcharge)

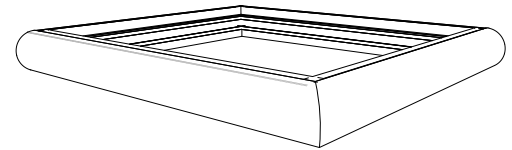
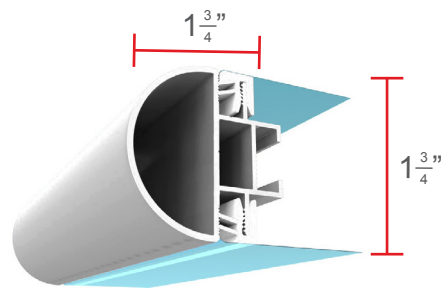



Partitions

Partitions are a practical way to separate two areas of one room or isolate the sound of one area from another. Its decorative aspect is most appealing, especially in commercial and retail spaces where they are used for branding purposes.



2" Partitions

Flat Frame

Item number: CPA67
Type of use: Aluminum profile for self-supporting frame. Single or double fabric layer.
Available finishes: White, black, anodized, untreated or custom color aluminum (with surcharge)

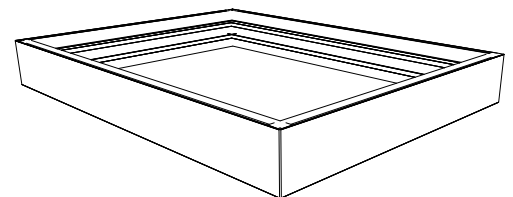
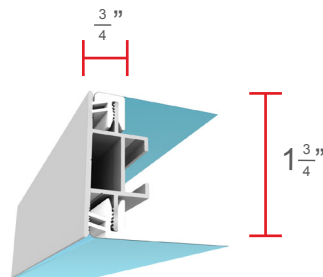

Round Frame

Item number: CRA68
Type of use: Aluminum profile for self-supporting frame. Single or double fabric layer.
Available finishes: White, black, anodized, untreated or custom color aluminum (with surcharge)

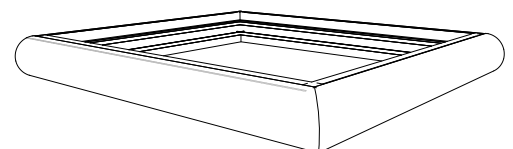
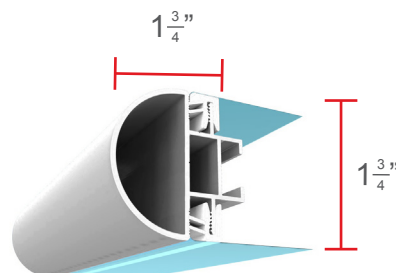

4" - 5 1/2" Partitions

4" Frame

Item number: CAC100

Type of use: Aluminum profile for self-supporting frame.

Single or double fabric layer.

Available finishes: White, black, anodized, untreated or custom color aluminum (with surcharge)

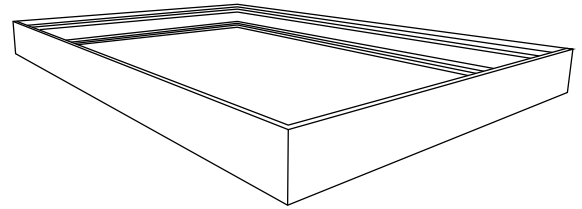
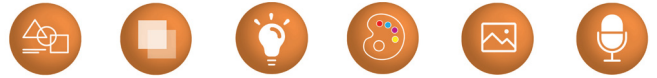
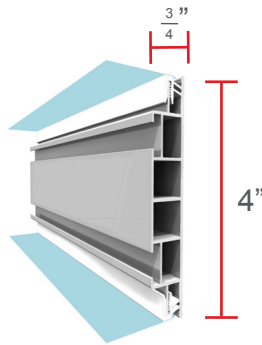

5 1/2" Frame

Item number: CAC140

Type of use: Aluminum profile for self-supporting frame.

Single or double fabric layer.

Available finishes: White, black, anodized, untreated or custom color aluminum (with surcharge)

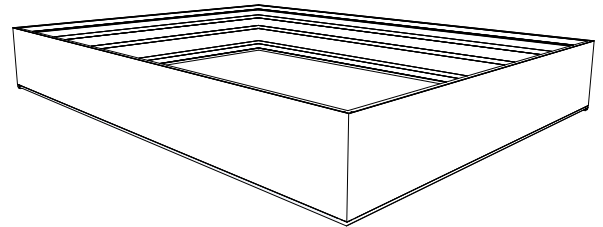
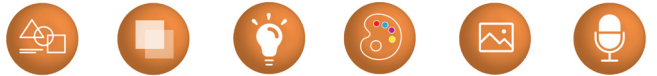
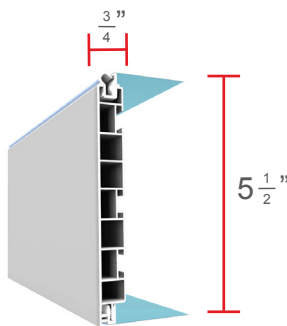

AEROCustom



AEROCEILING® provides custom-shaped clouds to meet your specific design needs. AEROCEILING can capture the beauty of nature in shapes such as rain drops, waves, clouds, etc. Profiles are bent to produce the desired shape and size.

You can choose to make your frame acoustic, backlit and/or printed with a custom image. These shapes can be hung, wall mounted or freestanding.

Custom Shapes

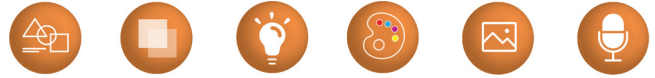

Custom Prints

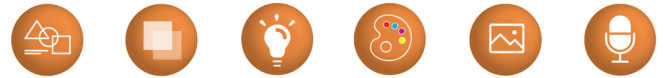

CLIPSO Design® services enable you to have all the photos you love on your ceilings and walls. You can choose from our different collections and themes by visiting www.clipsodesign.us, our dedicated site for custom printing. CLIPSO Design constantly renews its image collections to offer a wide range of images for you to choose from.



You may also customize your print frame with a stock image or submit different types of images, such as a personal photo, that you would like printed on a wall frame or ceiling cloud.



AEROLight



AEROCEILING® frames include a broad offering of backlit displays and lightboxes. They can be used as the main light source for a space or as a decorative feature to create ambiance. Additionally, the backlighting feature will significantly enhance the dramatic effect of a print. Backlit totems or wall frames, with easily replaceable signage, are essential in the retail industry. AEROCEILING frames can be adapted to integrate different types of lighting, including LEDs, fluorescent lighting, etc.





There are several options available to add light to your AEROCEILING® cloud when used with CLIPSO Translucent Fabrics available in 30%, 50% and 70% translucencies.

LED Module Lighting

- Lighting is contained inside the frame
- Provides an even light flow of up to 16'
- Light modules specifically designed with a 10° light spread
- Cleaner, more uniform look
- More frame configurations available
- Makes relocating easy
- Lower material cost
- Lower installation cost
- Longer bulb life

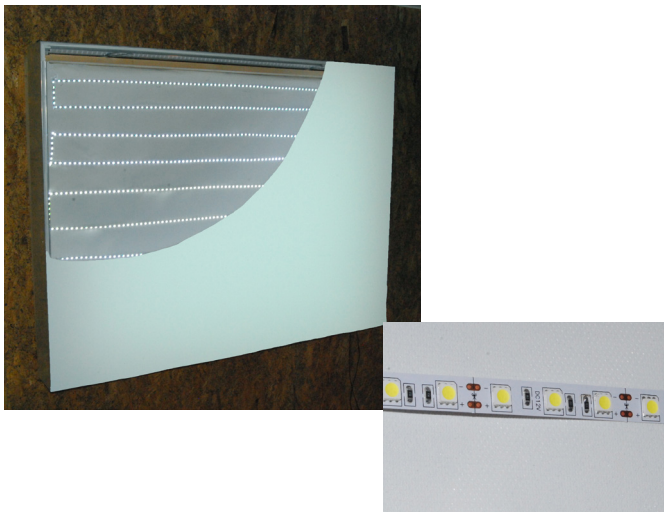

LED Strip Lighting

- Lighting is contained inside the frame
- Provides an even light flow
- Cleaner, more uniform look
- More frame configurations available
- Makes relocating easy
- Higher material cost
- Higher installation cost
- Longer bulb life

Fluorescent Lighting

- Lighting is located outside the frame
- Light source more prone to hot/cold spots
- Light fixtures more difficult to position and install
- Makes relocation more difficult
- Lower material cost
- Higher installation cost
- 12 month average bulb life



AEROSilent



AEROCEILING® acoustic clouds for ceilings and walls are the perfect acoustic solution thanks to their sound absorbing performance with Noise Reduction Coefficients (NRC's) of up to 1.05. These frames have high acoustic qualities while remaining aesthetically pleasing. AEROCEILING acoustic clouds are 100% customizable in terms of color, printing, shape and backlighting.

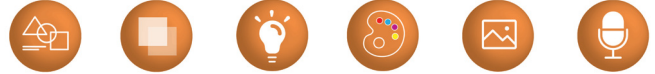

AEROCEILING acoustic clouds are covered with a micro-perforated fabric and acoustic batting, which is placed within the aluminum structure of the frame. A plenum space between the acoustic covering and the batting improves the acoustic performance of your frame.

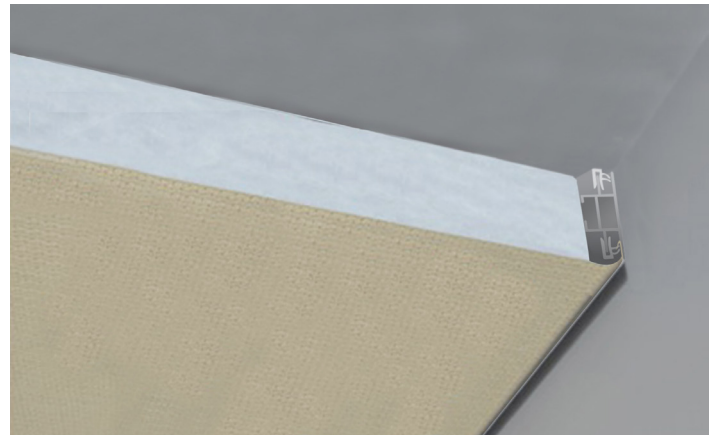

Acoustic Absorption Test Results:
No insulation and with insulation LA54

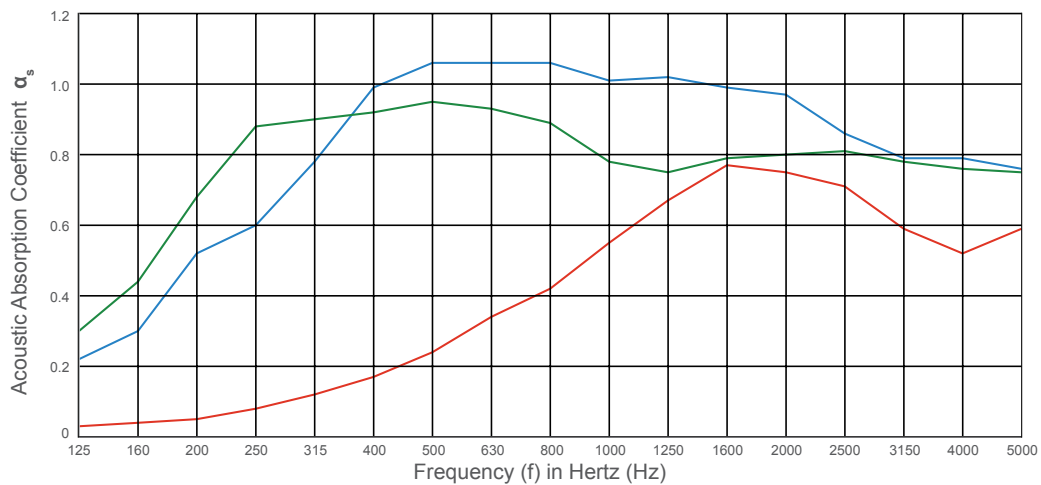

◆ 495 D fabric with insulation LA54
Test Report BAE N° 13-340/04
Plenum Space: 2.25"

$\alpha_s = 1$ - Classification A

◆ 495 D fabric with insulation LA54
Test Report BAE N° 13-340/08
Plenum Space: 6"

$\alpha_s = 0.85$ - Classification B

◆ 495 D fabric without insulation
Test Report CSTB N° AC10-26027831
Plenum Space: 2.25"

$\alpha_s = 0.30$ - Classification D

AEROAccess



When access to plenum is required, the AEROCEILING® Torsion Spring System is the solution. Functioning with a system of brackets, torsion springs, and clips, this system allows accessibility when needed.

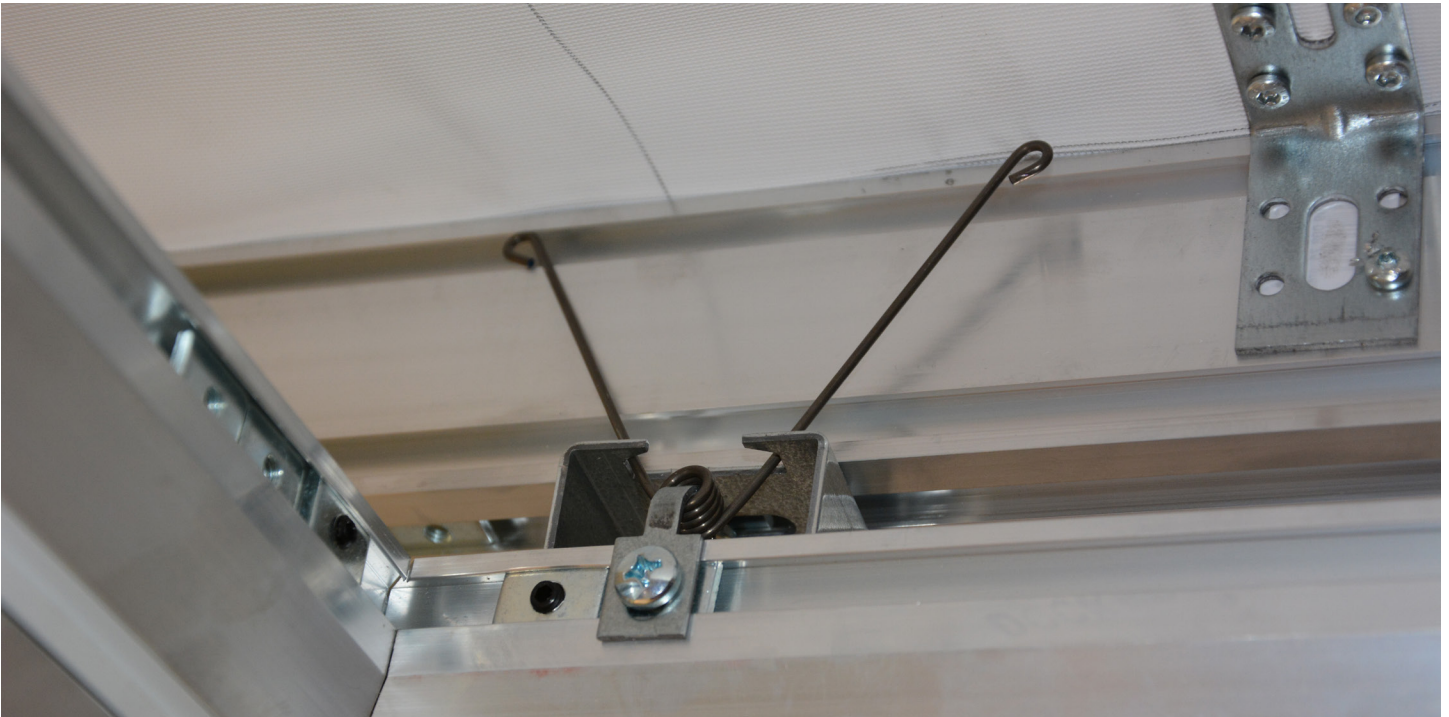
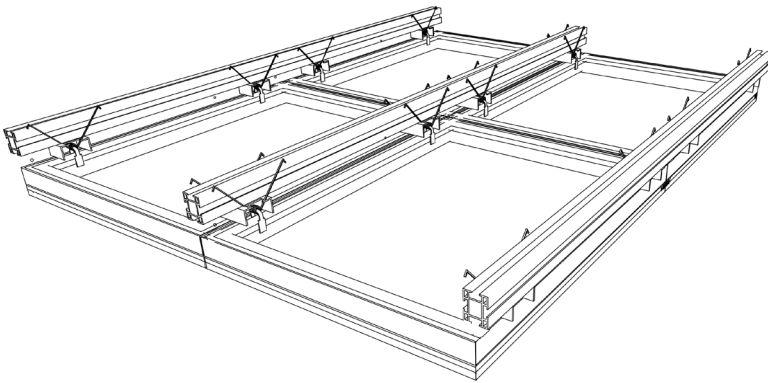

AEROC EILING®

SUSPENDED CEILING & WALL FRAMES



CLIPSO® = LEED

Not only are CLIPSO specialty textiles an exceptional interior finish for ceilings and walls, they contribute to LEED credits. Our polyester mesh contains no polyvinyl chloride, phthalates or any other cancer-causing materials, unlike PVC-based products. Our VOC-free fabric meets the USGBC LEED criteria for indoor air quality IEQ4.2.

Beyond creating exceptional interior environments, CLIPSO works to preserve the environment for future generations. Use of our products results in extremely minimal construction waste compared to traditional building materials like sheet rock and ceiling tiles. CLIPSO products are manufactured using methods to reduce our carbon footprint and are 100% recyclable.

For more information about our products or services, visit our website at www.clipsoceilingwall.com or email us at contactusa@clipso.com.

CLIPSO Americas, Inc.
200 Corporate Drive, Unit 4
Blauvelt, NY 10913
(646) 422-0919
www.clipsoceilingwall.com

