

Alumi



abstracta

www.abstracta.se

Alumi

Design Nina Jobs



Alumi är ett stilfullt skärmsystem med flera olika valmöjligheter. Golvskärm, bordsskärm och kombinationsskärm med skrivvyta.

Alumi is a stylish screensystem with several different options. Floor screen, table screen and a combination screen with writing surface.



En ny hörnkoppling har utvecklats för att ge möjlighet att pussla ihop alkover för enskilda arbetsplatser likväl som mötesrum: Alumi alkov. Skärmarna går att få med antingen raka eller runda hörn för extra fint avslut.

A new kind of aluminium corner connection has been developed simply to join the alcoves together to form a work room or meeting space: Alumi alcove. The screens are available with either straight or rounded corners.



Bordsskärmen finns i två varianter, en variant för att fästa på bord alternativt nedhängande. Dessa går även att få med raka alternativt runda hörn.

The screen is available in two types, attached to the table or a modesty panel. Available with straight or round corners.



Alumi kombi är den ultimata kombinationen av skrivvyta och akustik.

Alumi combi is the ultimate combination of writing surface and acoustics.



i Teknisk information/Technical information

Alumi golvsskärm/Alumi floor screen

Valbara filtmonster på s. 7
Available felt patterns on page 7

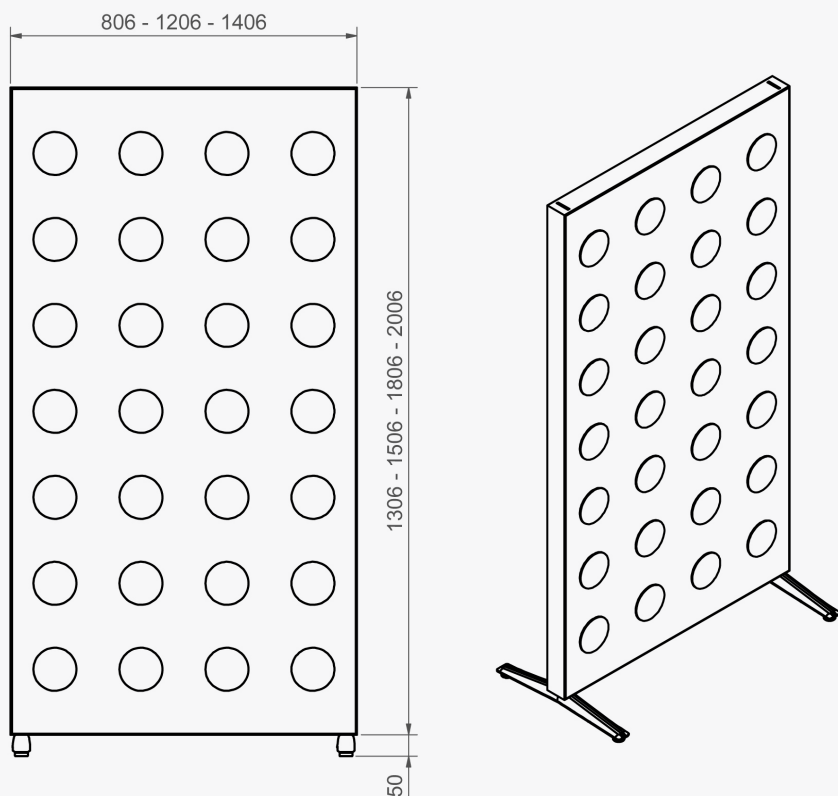

Alumi rund/Alumi round

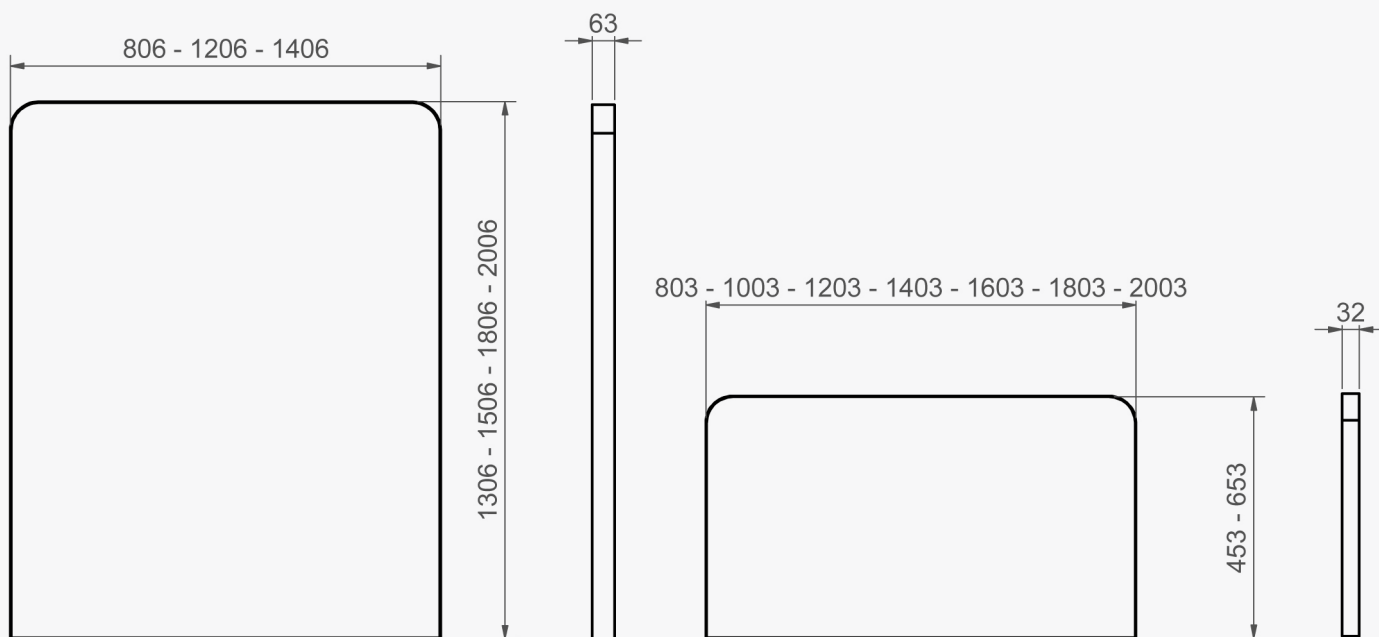

i Teknisk information/Technical information

Alumi bordsskärm/Alumi table screen

Valbara filtmonster på s. 7
Available felt patterns on page 7

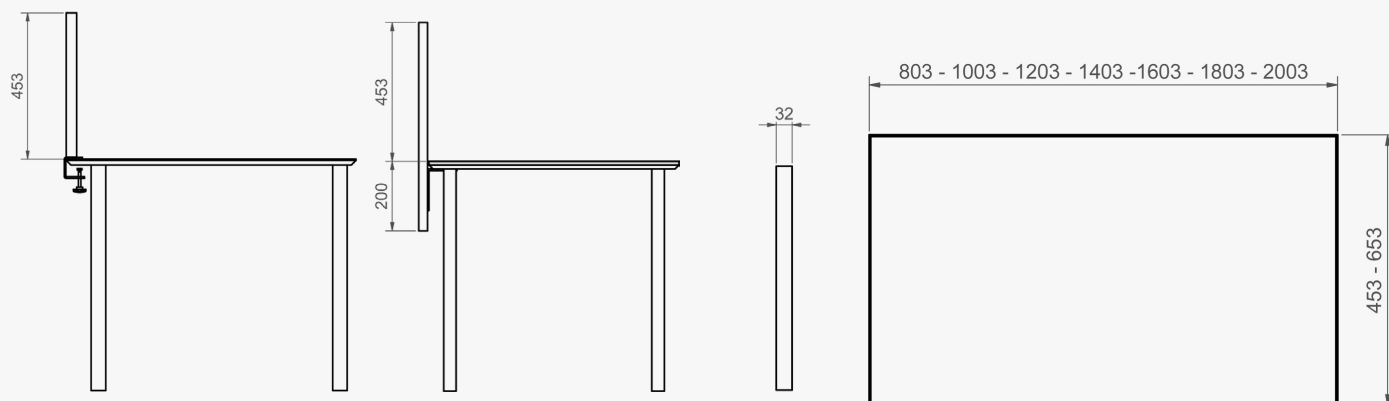

Alumi kombi/Alumi combi

Valbara filtmonster på s. 7
Available felt patterns on page 7

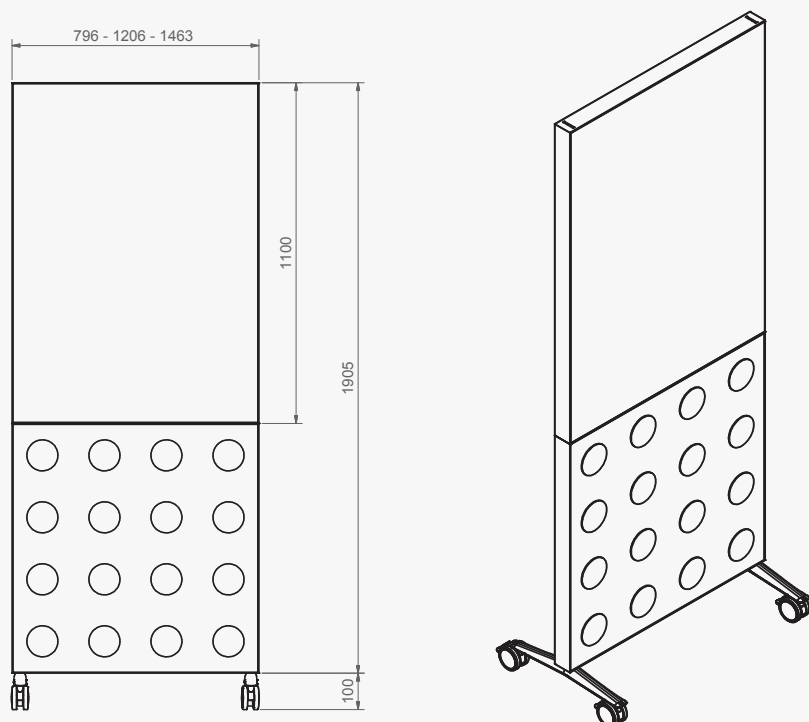

i Teknisk information/Technical information

Alumi alkov/Alumi alcove

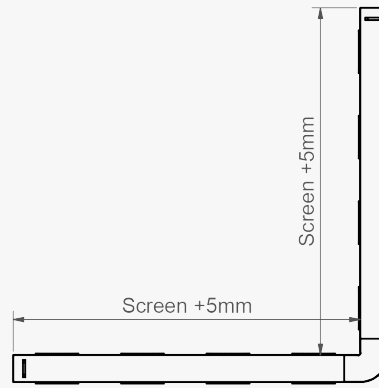
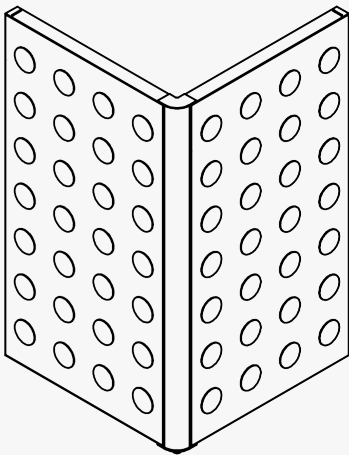

Exempel på kombinationer för Alumi alkov/
Example combinations for Alumi alcove

A.

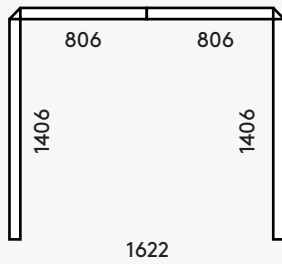

B.

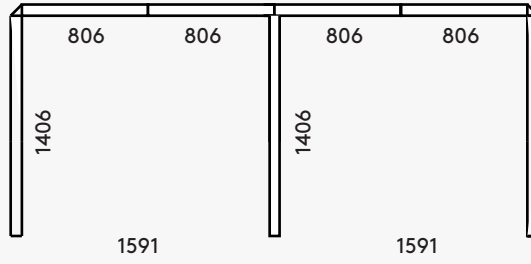

C.



D.

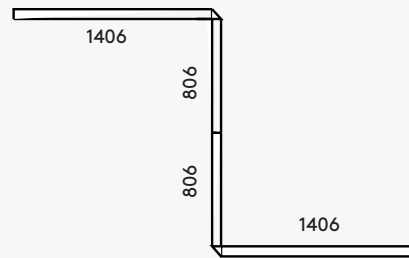

E.

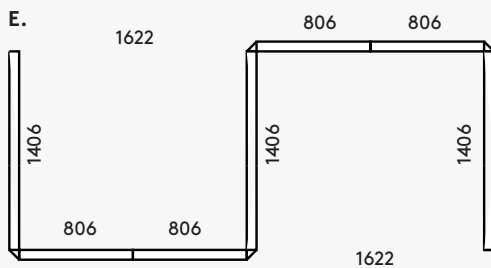

F.

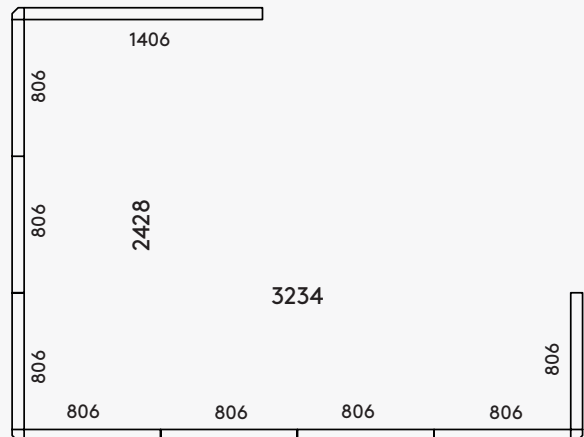

Teknisk information/Technical information



Gjutna ben

Gjutna ben finns tillgängliga i naturanodiserat eller vitlack, RAL 9010. Justerbara ställfötter eller låsbara hjul. Benhöjd 57 mm från golvet, undantag gjutet stödben med hjul: 127 mm från golvet.

Molded legs

Available in silver anodized or white lacquer, RAL 9010. Adjustable feet or lockable castors. Leg height 57 mm from floor, except from legs with castors; 127 mm.













Basic ben

Metallfot finns tillgängliga i grå lack, RAL 9006. Justerbara ställfötter eller låsbara hjul. Benhöjd 30 mm från golvet, undantag ställfot med hjul: 100 mm från golvet.

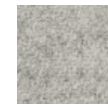
Basic legs

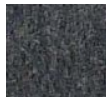
Available in grey lacquer finish, RAL 9006. Adjustable feet or lockable castors. Leg height 30 mm from floor, except from legs with castors; 100 mm.

Färgval/Color Choices

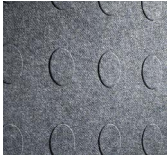
| | | | |
|--------------------------------------|---|--|--|
| | Camira Blazer lite | | Filt/Felt |
| Slät/plain: |  -95 (LTH45) |  -92 (LTH41) |  -93 (LTH42) |
| |  -94 (LTH43) |  -90 (LTH39) |  -91 (LTH70) |
| | | |  -13 |
| | | |  -12 |
| | | |  -11 |
| Filtmönster/ felt pattern | Block  -18 vit/white -15 ljusgrå/light grey -16 mörkgrå/dark grey | Dot - (obs! ej för bordsskärm/note! not available for table screen)  -01 vit/white -02 ljusgrå/light grey -03 mörkgrå/dark grey | |

Ramen till Alumi är vit alternativt naturanodiserad aluminium./The framework for Alumi is white or silver anodized aluminium.

Psykiatrins hus, Uppsala

“Vi valde att arbeta med Abstractas skärmar för den stabila konstruktionen, designen och absorptionen. De håller för stötar och liknande medan den tunna stålramen ger tygskärmarna en vacker inramning”

“We chose to work with Abstracta screens for the stable construction, design and absorption. The screens are stable as well as beautiful due to its thin steel frame”

Kristin Östberg
Indicum Arkitekter



Fotograf: Jason Strong

abstracta

Box 75, Lammengatan 2, SE-360 30 Lammhult, Sweden

T +46 472 26 96 00, F +46 472 26 96 01

info@abstracta.se

www.abstracta.se