

0800 389 9072
www.ablecanopies.co.uk

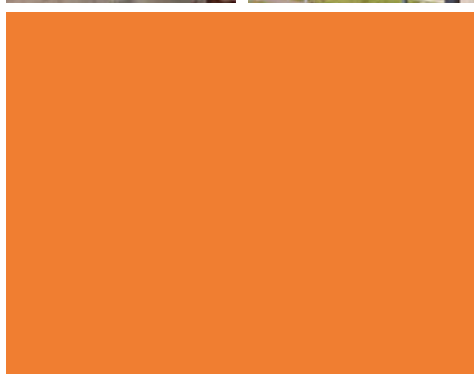

The Able Canopies Product Portfolio



able
canopies
& outdoor projects



Able Canopies

Able Canopies design, manufacture, supply and install quality canopies, shelters, covered walkways and shade systems to commercial organisations throughout the UK. All our products are carefully designed to create attractive and usable exterior spaces, whilst offering cost effective weather protection.

Our dedicated team are committed to providing superior quality products to you with a personal customer service which is second to none. We offer a complete turnkey solution - working with you at all stages of the design, supply and installation of your structure - whether it is a stand-alone project or part of a complex building project.

Our Story

Just over 15 years ago, we had a vision to offer a comprehensive range of quality and cost effective canopies to the commercial sector. This set us on our journey to be "The Canopy Experts" who could offer the largest range of weather protection solutions in the UK.

At the beginning of our business, we worked mainly with schools and nurseries, supplying wall mounted canopies to create playground shelters and outdoor classrooms. However, we knew that our canopies could also make a difference in many other sectors, and so, as our range expanded to incorporate free standing canopies, we also began working with other sectors including healthcare and hospitality, local authorities, architects and contractors.

Throughout our journey we have always held true to our core values that our customers should receive the best possible products and service, and with this in mind we adopted cutting edge 3D design software early on in the company's lifetime to enable us to create stunning structures, which are also functional and adaptable.

This also allowed us to create bespoke structures and we now have a dedicated Design & Build team who can turn ideas and hand sketches or CAD drawings into creative and workable solutions.

Over the years we have incorporated a wide selection of materials into our range including steel, Glulam timber and aluminium, all of which can be fitted with a wide range of roofing options including polycarbonate and tensile fabric. And as our expertise has grown, so has our business, with 4 offices across the UK on hand to help customers with all their shade and shelter needs. Still a family business at heart, Able Canopies has grown from a team of 3 to over 30 employees, and it won't be long before we employ even more!

As "The Canopy Experts" we are constantly reviewing our products and service to ensure we exceed our customers' expectations, from initial contact right through to installation and beyond. So you can rest assured that by working with Able Canopies you will not only benefit from our expertise, but also receive a service and product of the highest quality.



Our Complete Service - the 6 stage process

1. Enquiry

Our technical sales advisors are on hand to discuss your initial ideas by phone or email, to ascertain the most suitable cover options that meet your requirements and budget. We offer exceptional nationwide cover with a guaranteed swift and efficient service, which enables us to conform to tight deadlines and bring the best value to all our customers.

2. Survey

We provide free, no obligation site surveys to qualifying customers. Our fully trained and DBS checked surveyors will carry out a thorough site assessment and offer practical solutions and advice to ensure you receive accurate drawings and quotations.

Following your survey, we will be able to provide a firm quotation, not a vague estimate. Our quotations have no hidden extras and will be inclusive of delivery, and installation if required.

3. Design

Our Design department can provide technical drawings in a range of formats, and accurate visualisations of your chosen structure in location, to allow all key decision makers to see how your new structure will fit in with the existing surroundings.

If you have a unique design in mind, we also offer a Design & Build service to enable you to bring your idea to life. Our team have extensive experience of working with architects, designers and specifiers, and can work from hand drawn sketches to CAD drawings to transform your vision into a workable, cost effective solution.

4. Manufacture

We manufacture our products in-house, which allows us to fabricate our range of canopies and shelters to your exact specifications, with a fast turnaround to fit perfectly with your building schedule.

In the manufacturing of your product, we offer the option of a powder coated and/or galvanised finish on all steel framework, and our aluminium framework can also be powder coated to any RAL colour, allowing you to customise your structure to match or complement your building or setting.

5. Installation

Once we have received your order, we will arrange a date for the installation that is convenient for you. A pre-commencement site meeting will also be arranged for us to thoroughly assess and discuss all health and safety requirements, logistics and other important details with you to ensure a safe and successful installation.

In the event of the need for a planning application, we offer free help and advice to help you obtain permission. Please see page 5 for more details.

All our canopy products are installed by our fully trained and DBS checked installation teams. All our teams undergo intensive and thorough training to ensure that your structure is installed safely and to the highest standard with minimal disruption to you.

6. Service

We have a network of customer support advisors who can help with any queries or problems prior to, during, or after your order and installation. We are pleased to offer free funding and planning advice as part of our service to you, and, if you choose to order from us, we will provide regular updates to allow you to track your order's progress.

We also offer a comprehensive After Sales service which includes a customised After Sales Pack and an on-site after installation meeting if required (depending on the project).

Our excellent customer satisfaction record speaks for itself, and our ongoing client support and advice continues long after installation, resulting in many of our customers returning time and time again!

At Able Canopies, we understand the importance of delivering consistent high quality through every process that we do, both “behind the scenes”, and through our customer service. As part of this commitment to our customers we have been assessed by the British Assessment Bureau and have achieved the internationally recognised ISO 9001 quality standard.



Our Commitment to Quality, Health & Safety, the Environment and You

We are also dedicated to ensuring the health and safety of our staff and customers and this has led us to strive for, and achieve, numerous certifications including OHSAS18001 (Soon to be ISO45001), CHAS Premium Plus and Constructionline Gold. In addition to these certifications, we have also achieved ISO14001 which recognises the management of, and commitment to the environment in which we operate.

Our products will always be installed by one of our fully trained fitting teams to ensure your products are finished to the highest possible standards. The teams are DBS checked and fully HSE compliant. All training is ongoing and includes the following:

- › All installation team leaders hold the CITB’s Site Supervisor’s Safety Training Scheme for the Construction and Civil Engineering Industries
- › Construction Skills Certificate Scheme (CSCS) to improve the quality of work on site and reduce accidents
- › Asbestos awareness - to have an awareness of asbestos
- › First Aid - there is always a qualified first aid representative on site
- › Manual handling - training on manual handling and how to prevent injuries
- › CAT and Genny training to avoid danger from underground services
- › Ladders and steps - basic training for working at heights
- › PASMA - specific training in the use of access equipment.

For each installation we also ensure that the site area is fenced off for the safety of staff, students, customers and their visitors and we will always leave the site clean and tidy upon completion.



Helping you with Funding, Planning and more...

Planning Permission

Planning permission is sometimes required before a canopy or shade system can be installed. In cases where this is necessary, we can work closely with you, advising what you need and where you can get it from.

The help and advice we provide is free of charge however, we cannot cover the cost of the application and any necessary maps required for the application.

Ask us to send you our Free Planning Guide, which explains the planning process and how we can help.

Funding

Our Funding Research Team are constantly searching for new funding opportunities to help our customers fund their new canopy or other equipment needed. You could be eligible for up to £50,000 to spend on:

- › New equipment, hardware or furniture
- › Improvements to your building or outside space
- › Sports or play area equipment
- › Computers and IT equipment for your pupils
- › Canopies, walkways, shade sails or bike storage facilities

We are regularly finding new funding sources as they become available and we would like to share this information with you to help you finance any new equipment or projects you may have in the future.

Ask us to send you a FREE Funding Guide today for details about funding available to you.





Contents

WALL MOUNTED CANOPIES 8		Double Grange	45	Tintern	74
Aluminium Canopies		Hamilton	46	Tamworth	75
Coniston 35	10-14	Aluminium Canopies		Balmoral	76
Coniston 35 - Colour Options	15	The Coniston (Rear Goal Posts)	47	Lexden	77
Coniston 6	16	Optional Extras for Wall Mounted, Steel and Free Standing Canopies 48-49		Fenwick	78
Ashton - Glass Canopy	19	WALKWAYS 50		Nelson	79
Timber Canopies		Ullswater	52	Tenby	80
Tarnhow	21	The Coniston	53	Colwyn	81
Tarnhow Mono	22	Welford	54	BIOCLIMATIC PERGOLAS 82	
Tarnhow Curved	23	Welford Junior	55	Imperial Senior	84
FREE STANDING CANOPIES 24		Ennerdale Junior	56	Imperial Grand	85
Steel Canopies		Devoke Junior	57	Optional Extras 86-87	
Welford Dome	26	Grange	58	INTEGRATED SOLAR CANOPIES 88	
Welford Dome Junior	27	Grange Junior	59	The Albedo	92
Devoke	28	ENTRANCE CANOPIES 60		Grange Mono Pitch	94
Devoke Junior	29	Ullswater	62	Grange Apex	96
Grange	30	Beck	63	Kensington Mono Pitch	98
Grange Junior	31	Kensington Wall Mounted	64	Kensington Dual Pitch	100
Ullswater	32	Kensington Junior	65	BESPOKE CANOPIES 102	
Whiteside	33	Whiteside	66	Design and Build	104
Kensington Mono Pitch	34	Welford Dome	67	Glass Canopies	105
Kensington Dual Pitch	35	Ainsley	68		
Kendal	36	Orwell	69		
Timber Canopies 38-39		Earlswood	70		
Tarnhow Dome	40	Redford	71		
Tarnhow Mono	41	Abberton	72		
Tarnhow Curved	42	Ferndale	73		
Large Span Canopies					
Tarnhow Dome	44				



Sectors Key

Throughout this catalogue you will find sector icons to indicate what the canopy, sail or tensile structure is suitable for. These sectors are shown below.



Residential



Education



Hospitality
& Leisure



Retail &
Commercial



Healthcare



ABLE SHADE SAILS 106

Able Shade Sails 108-109

Optional Extras and Fabric Colour Options 110-111

TENSILE FABRIC STRUCTURES 112

Codale Conic 114
 Codale Junior 115
 Ulverston Umbrella 116
 Blenheim Umbrella 117
 Dallington Umbrella 118
 Keswick Umbrella 119
 Windsor Umbrella 120
 Evershade Umbrella 121
 Drayton Umbrella 122
 Richmond Umbrella 123
 Kendal 124

Optional Extras and Fabric Colour Options 125

COMMERCIAL AWNINGS 126

Palladio 128
 Australia 129
 Pergolino 130

Optional Extras and Fabric Colour Options 131

SHELTERS & COMPOUNDS 132

Cycle & Waiting Shelters
 Langdale 134
 Grasmere 135
 Witton Wall Mounted 136
 Witton Free Standing 137
 Easydale 138
 Coniston 139
 Ainsley 140

Timber Cycle & Waiting Shelters
 Denver 141
 Pembroke 142

Shopping Trolley Shelters
 Ainsley 143

Bus Shelters
 Ainsley 144

Buggy Shelters
 Meadley 145
 Easydale 146

Bin Shelters
 Grasmere 147

ALUMINIUM DECKING 148

Standard Aluminium Decking 150
 Slip Resistant Aluminium Decking 151
 Balcony Decking 152
 Flat Balcony Decking 153
 Rooftop Terrace Decking 154
 Supa Joist 155

OUTDOOR PROJECTS 156

Artificial Grass 157
 Soft Play Surfacing 157
 Tarmac 157
 Aluminium Decking 157
 Commercial Fencing 157



01

Our Wall Mounted Canopy range features our most popular canopy, the Coniston, a fully aluminium structure with integral guttering, and our wall mounted Tarnhow canopies which are constructed from Glulam timber with polycarbonate roof panels.

Wall Mounted Canopies

Coniston 35
Coniston 6
Ashton
Tarnhow Mono Timber
Tarnhow Curved Timber







The Coniston wall mounted canopy is our most popular product due to its adaptive versatility, which allows it to span to any length with a maximum projection of 6 metres. It can also be installed to fit around internal and external corners, and can even wrap around the complete perimeter of a building.

The Coniston offers shade and shelter with high UV protection to those beneath the canopy, and if fitted above a building's windows it can also provide shade to those internal rooms, mitigating unwanted heat and glare on sunny days.



Coniston 35

Wall Mounted Canopies



Residential



Education



Hospitality
& Leisure



Retail &
Commercial



Healthcare

Features and Benefits

10 YEAR GUARANTEE:

The Coniston carries a full 10 year insurance backed guarantee so you can rest assured that your canopy is of the highest quality.

25 YEAR LIFE EXPECTANCY:

Our canopies have a life expectancy of up to 25 years, subject to the chosen finish, giving you peace of mind that our products are made to last.

SIZE:

To your specification.
Length: Unlimited
Projection: Up to 6 metres
Height: To your specification

FLEXIBILITY IN DESIGN:

The Coniston can fit around your entire building due to its ability to fix around external and internal corners.

FRAMEWORK FINISH:

The aluminium framework and posts are powder coated white as standard, or can be powder coated to any RAL colour of your choice.

PANELS:

The Coniston is covered with 35mm structured polycarbonate roof panels which are light in weight and up to 200 times stronger than glass and 10 times stronger than uPVC panels. These panels are also vandal and shatter resistant and offer high levels of UV protection.

WEATHER RESISTANCE:

During the manufacture of our polycarbonate panels, a layer of UV absorber is co-extruded into the surface forming a barrier which gives up to 99% UV protection from the sun. The frame and all structural components are made from aluminium for total weather resistance.

GUTTERING:

Fitted with integral aluminium guttering as standard, this guttering can be connected to the building's existing guttering system. uPVC downpipes are supplied as standard.

EXCELLENT FIRE PERFORMANCE:

Our structured polycarbonate sheets benefit from excellent fire performance, meeting standards including BS476 Part 7, Class 1 and EN 13501 B-S1, d0. Furthermore, they do not emit toxic gases, unlike uPVC panels.

OPTIONAL EXTRAS:

- >The Victorian Upgrade
- >Signage
- >The Rainbow Package
- >5mm Polycarbonate Side Fills
- >Secure Roller Shutters
- >Post Pads

See pages 48-49

USES:

- > Playground canopy
- > Covered waiting area
- > Entrance area
- > Covered outdoor learning area
- > To reduce heat inside buildings



Coniston Construction

WALL BEAM

The Coniston's fully aluminium wall beam is easy to install and will achieve 2.5 degrees to 45 degrees, giving you maximum scope for the height at the back of your canopy.



POLYCARBONATE 35

Our lightweight 35mm polycarbonate roof panels are up to 200 times stronger than glass and 10 times stronger than uPVC panels.

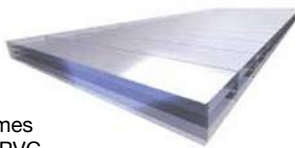

ROOF BARS

Heavy duty structural aluminium roof bars provide the Coniston with ultimate strength (i value 180).



INTEGRAL GUTTERING

Saves time on installation and has a sleeker design which is also stronger than an external gutter system.



FLASHING STRIP

The flashing strip attaches to the eaves beam with integral guttering to determine the pitch of the canopy.



The Coniston's frame is constructed completely from aluminium which offers unbeatable durability; it also features integral guttering which creates a polished finish to the canopy's aesthetics and allows for easy maintenance.



Design Specifications

The Coniston

The Coniston has been specifically designed to perform in climate conditions that may exist in most given areas of installation. The main factors which are taken into account when deciding on structural design parameters are:

1. Imposed & Super Imposed Load (Wind and Snow)
2. Penetration by Hailstones (Roofing Sheets)
3. Wind Uplift
4. Non – Fragility (Roof)

1. (A) IMPOSED LOAD

In the case of imposed wind loads, our structured polycarbonate sheets, supplied to a maximum width of 1000mm and length of 6000mm, used in conjunction with our canopy system, are capable of withstanding imposed wind loads of up to 1.2 kN per square metre depending on location and size of canopy. A technical specification chart is available on request - please contact us for more details.

In the case of “dead” or imposed loading (including snow) these same sheets and glazing bars can withstand loads in excess of 100 kilograms per square metre.

1. (B) SUPER IMPOSED LOAD

An example of super imposed loads would be snow moving from an overhanging or adjacent roof onto a canopy thus exacerbating loads already imposed. Where such a load occurs, it is considered to be over and above any load which has been accounted for in the structural calculations referred to in this design specification. Accordingly, although due account of the possibility of a super-imposed load will be considered prior to installation, the

failure of any canopy due to these factors is deemed to be outside the control of the supplier. We recommend the use of snow guards above the canopy.

2. PENETRATION BY HAILSTONES

The possibility of hail penetration to the roofing sheet has been independently tested and is guaranteed to withstand (simulated) conditions produced using a 20mm diameter shot, travelling at 21 metres per second.

3. WIND UPLIFT

In the case of wind uplift, the main design consideration is given to the size of the concrete footing in relation to the area of the canopy and the distance between the supporting posts. Wall mounted canopies which are designed to be used in urban and suburban areas, up to 5 metres above ground level and are correctly installed according to instruction, require one set of support posts to be fixed into a concrete base of 0.96 cubic metres, with a maximum distance between posts of 3.5 metres for projections up to 3 metres and 3 metres for projections from 3 metres to 6 metres.

The posts are fitted to the eaves beam of the canopy using high grade aluminium cleats (3mm thick), self drilling fixings with a minimum breaking torque of 0.216n/m and bolts with a similar breaking torque. Where climatic (or other) design conditions dictate, the above criteria may be altered. Wall mounted canopies which are designed for use in these areas, require one set of support posts to be fixed into a concrete base from 0.1 cubic metres, dependent upon site conditions, with a maximum distance between (any 2) posts of 3.5 metres, up to a 5 metre projection. This specification is designed to withstand uplift loads in excess of those normally experienced in rural and coastal areas.

Note:

In areas where extreme weather conditions are experienced, including those areas of the United Kingdom which have mean snow levels in excess of 1.2 kN per square metre, site specific calculations may be required in order to assess the suitability of a wall mounted canopy. Such calculations will need to be commissioned by the prospective client, alternatively we can, on your behalf, instruct a structural engineer, with all costs incurred being passed to the client. Projections between 5 and 6 metres may require extra underside support.

4. NON-FRAGILITY

Our Coniston roof system is classified as non-fragile and complies with the ACR[M]001:2014 'Test for Non-Fragility of Profiled Sheeting Roofing Assemblies', achieving a B classification which is the highest rating possible for a polycarbonate roof.

➤ Full design specification available on request.

The posts, which can be protected with post pads, give the canopy extra strength

The down force is shared between these two points making the structure much stronger

The aluminium construction and 35mm polycarbonate panels provide a strong low maintenance surface

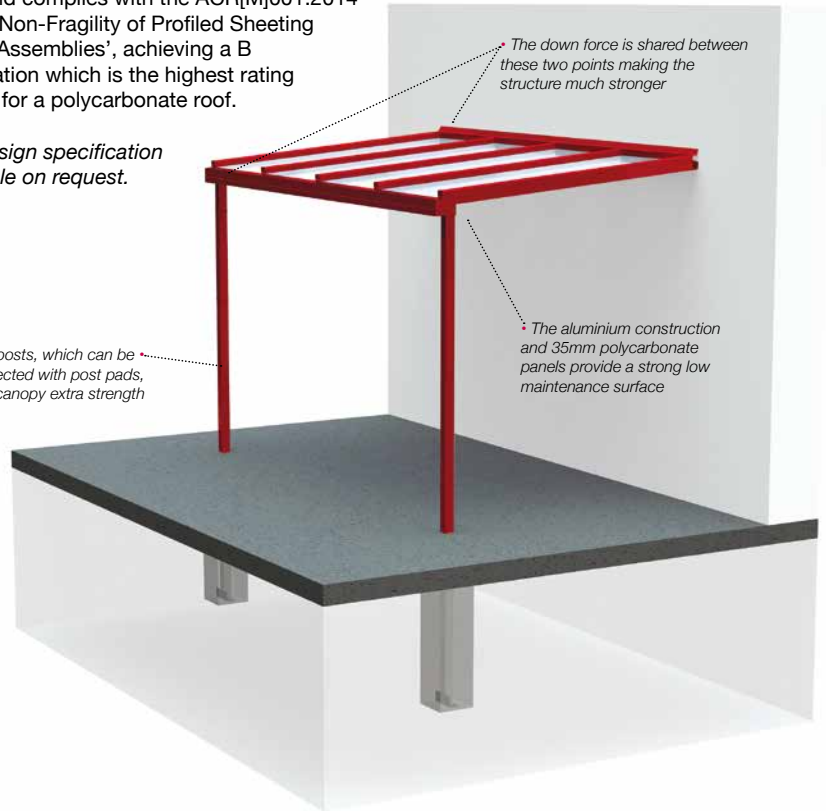

Valley Canopies

Our valley canopies can cover large areas of up to 12 metres between buildings and can be constructed to any length. This type of canopy benefits from using a single set of posts forming an attractive, cost effective structure, with two wall mounted canopies meeting together at the centre.



Total flexibility in design

The Coniston



Variable Wall Plate

The Coniston can be designed with a variable wall plate which allows the canopy to provide uninterrupted cover along the full stretch of an external wall, incorporating alcoves and other design features easily into its construction.

Elevated Structures

The Coniston can be fitted onto an existing steel balcony structure. The canopy above was installed at Hinguar Primary School in Essex. This allowed them to make use of an area which could otherwise only be used on dry days. Side fills were also added to provide complete cover from the wind and rain and also provide high UV protection from the sun.



Colourful Canopies

The Coniston frame is supplied in Hipca White as standard however, it can also be powder coated at an additional cost to any RAL colour to match your existing colour scheme or create a striking contrast. Choose to have just the canopy roof frame, the canopy posts, or the whole canopy frame and posts powder coated to the RAL colour of your choice. View the full RAL colour chart at www.ablecanopies.co.uk.

Available colour options

The Coniston





Coniston 6

Wall Mounted Canopies



Residential



Education



Hospitality
& Leisure



Retail &
Commercial



Healthcare

The Coniston 6 is a strong aluminium wall mounted canopy that can be covered with either 6mm toughened glass or 6mm solid polycarbonate roof panels.

It is similar to the Coniston 35, yet it features a smaller frame making it ideal for more traditional style buildings, particularly when paired with the decorative Victorian Upgrade.

With an unlimited length and a maximum projection of up to 3.5m the Coniston 6 wall mounted canopy can provide weather protection for a range of uses including covered entrances, outdoor learning areas, covered walkways and outside dining areas.

Features and Benefits

10 YEAR GUARANTEE:

The Coniston 6 carries a full 10 year insurance backed guarantee so you can rest assured that your canopy is of the highest quality.

25 YEAR LIFE EXPECTANCY:

The Coniston 6 has a life expectancy of up to 25 years, giving you peace of mind that our products are made to last.

SIZE: To your specification.

Length: Unlimited
Projection: Up to 3.5 metres
Height: To your specification

FRAMEWORK FINISH:

The aluminium framework is supplied powder coated in a choice of White and Anthracite Grey (RAL 7016) as standard, other RAL colours are available at an additional cost.

ALUMINIUM FRAME:

Main frame: 70mm x 75mm x 2mm structural grade aluminium.

PANELS:

The Coniston 6 can be covered with either 6mm toughened glass or 6mm solid, clear polycarbonate. The polycarbonate roof option protects from over 98% of harmful UV rays and is vandal and shatter resistant.

INTEGRAL GUTTERING:

The Coniston 6 features hidden integral guttering with uPVC downpipes for a sleek appearance.

OPTIONAL EXTRAS:

- > The Victorian Upgrade
- > Signage
- > Rainbow Package
- > 5mm Polycarbonate Side Fills
- > Picnic Tables & Benches

USES:

- > Entrance canopy
- > Covered Walkway
- > Spa or gym canopy
- > Outdoor learning or play area
- > Alfresco dining area







Ashton

Wall Mounted Glass Canopy



The Ashton Wall Mounted Canopy is a high quality, fully aluminium system with a large span of 6 metres between the posts and a maximum projection of 6 metres.

The ornate profiles create a sleek and stylish look and can hide any cabling for additional extras such as heating and lighting. The roof is glazed with a choice of 8mm toughened glass which is extremely durable and class 0 fire rated or 35mm structured polycarbonate which is vandal and shatter resistant.

Glass sides and sliding doors can also be added to create a completely enclosed outdoor room and Infrared heating and lighting options are also available as well as post pads, signage, side fills and seating.

Features and Benefits

10 YEAR GUARANTEE:

The Ashton carries a full 10 year insurance backed guarantee so you can rest assured that your canopy is of the highest quality.

25 YEAR LIFE EXPECTANCY:

The Ashton has a life expectancy of up to 25 years, giving you peace of mind that our products are made to last.

SIZE: To your specification.

Length:	Unlimited
Projection:	Up to 6 metres
Height:	To your specification

FRAMEWORK FINISH:

The aluminium framework can be powder coated in any standard RAL colour. Non-standard RAL colours are available at an additional cost.

ALUMINIUM FRAME:

Main frame: 150mm x 150mm x 2.5mm structural grade aluminium.

PANELS:

The Ashton can be covered with either 8mm toughened glass or 35mm structured polycarbonate. The polycarbonate roof option protects from over of 98% of harmful UV rays and is vandal and shatter resistant.

INTEGRAL GUTTERING AND DOWNPIPES:

Hidden, integral guttering and downpipes for a sleek, clean appearance and for ease of maintenance.

OPTIONAL EXTRAS:

- > Pergolino Veranda (Roof Blinds)
- > Infrared Heating
- > LED Lighting
- > Glass Side Fills
- > Picnic Tables & Benches

USES:

- > Loading bay canopy
- > Spa or gym canopy
- > Outdoor learning or play area
- > Outside dining area





Tarnhow

Timber Wall Mounted Canopies



Residential



Education



Hospitality
& Leisure



Retail &
Commercial



Healthcare



Our Tarnhow canopies create a modern yet natural look and feel to your environment whilst providing you with a safe, sheltered area. Each Tarnhow canopy is constructed from Glulam timber which is sustainable, durable, fire resistant to BS 5268 and energy efficient to produce.



Tarnhow Mono-Pitch

Timber Wall Mounted Canopies



Residential



Education



Hospitality
& Leisure



Retail &
Commercial



Healthcare

The Tarnhow Mono-Pitch Wall Mounted Canopy is the most cost effective structure from the Tarnhow Timber Canopy range. It is ideal for creating a sheltered walkway or waiting area adjacent to your building. The canopy can also be used as an entrance canopy creating an attractive entrance to your building.

You can choose to have the Tarnhow Mono-Pitch fitted with either 5mm solid or 16mm structured polycarbonate panels.

Features and Benefits

SIZE: To your specification.
Length: Unlimited
Projection: Up to 6 metres
Height: To your specification

FRAME & POSTS:
 Bespoke Glulam and natural timber sections.

ROOF OPTIONS:
 5mm solid or 16mm structured vandal and shatter resistant polycarbonate roofing which is UV coated for high protection from the sun.

DESIGN:
 Mono-pitch roof creates a simple architectural feature which suits most building designs.

ROOF RAFTER BARS:
 Aluminium rafter bars are finished in Hipca White as standard, other colours are available at an additional cost.

GUTTERING & DOWNPIPES:
 uPVC guttering and downpipes supplied as standard – available in white, black or brown.

OPTIONAL EXTRAS:
 > Rainbow package
 > Post pads
 > Signage
See pages 48-49

USES:
 > Covered outdoor dining area
 > Covered walkway
 > Entrance canopy
 > Playground canopy



Tarnhow Curved

Timber Wall Mounted Canopies



Residential



Education



Hospitality
& Leisure



Retail &
Commercial



Healthcare

The Tarnhow Curved Wall Mounted Canopy is a stunning shade structure which has a curved timber roof frame and is ideal for creating a contemporary sheltered area adjacent to your building. This timber wall mounted canopy is perfect to use as a sheltered walkway or a covered seating area.

Due to its timber construction, this canopy is ideal for buildings located in areas of natural beauty, alternatively this canopy can make an attractive contrast when fitted against brick or steel structures.

Features and Benefits

SIZE: To your specification.

Length: Unlimited
Projection: Up to 6 metres
Height: To your specification

FRAME & POSTS:

Bespoke Glulam and natural timber sections with a choice of wood stains available on request

ROOF OPTIONS:

5mm solid or 16mm structured vandal and shatter resistant polycarbonate roofing which is UV coated for high protection from the sun.

DESIGN:

Curved roof creates a stylish addition to a building - giving it a contemporary edge.

ROOF RAFTER BARS:

Aluminium rafter bars are finished in Hipca White as standard, other colours are available at an additional cost.

GUTTERING & DOWNPIPES:

uPVC guttering and downpipes supplied as standard – available in white, black or brown.

OPTIONAL EXTRAS:

- > Rainbow package
- > Post pads
- > Signage

See pages 48-49

USES:

- > Playground canopy
- > Covered outdoor dining area
- > Covered walkway
- > Entrance canopy

02

With a wide range of free standing systems on offer including mono-pitch, apex and domed structures, we are sure to have a stand-alone solution for you.

Free Standing Canopies

Welford Dome
Welford Dome Junior
Devoke
Devoke Junior
Grange
Grange Junior
Ullswater
Whiteside
Kensington Mono-Pitch
Kensington Dual-Pitch
Kendal

Timber Canopies

Tarnhow Dome
Tarnhow Mono
Tarnhow Curved

Large Span Canopies

Tarnhow Dome
Double Grange
Hamilton

Aluminium Canopies

The Conston
(Rear Steel Goal Posts)







Welford Dome

Steel Dome Canopies



Residential



Education



Hospitality
& Leisure



Retail &
Commercial



Healthcare

The Welford Dome is an exceptionally versatile modular canopy, which can be used as a walkway, entrance canopy and a free standing canopy. With its ability to span across large areas and its simple yet contemporary design, the Welford Dome is the ideal canopy for playgrounds and outdoor dining areas.

Features and Benefits

25 YEAR LIFE EXPECTANCY:

Life expectancy of up to 25 years, subject to the chosen finish.

SIZE: To your specification.

Length: Unlimited
Width: Up to 6 metres
Height: To your specification

FRAMEWORK FINISH:

Framework and posts can be galvanised and/ or powder coated to any standard RAL colour.

STEEL UNDERSIDE FRAME AND POSTS:

Main frame: 120mm x 60mm x 3mm steel box section.

PANELS:

5mm solid or 16mm structured vandal and shatter resistant polycarbonate with built in UV protection. Available in clear or opal.

ROOF FRAME:

Steel roof frame, including steel roof bars and aluminium rafter bars. The steel bars are coloured in any standard RAL colour, other colours available on request and the

aluminium bars are coloured in Hipca White as standard, other colours are available at an additional cost.

GUTTERING & DOWNPIPES

Guttering and uPVC downpipes fitted as standard

UNIQUE CORNER STRUCTURE:

Our unique steel corner connection system gives ultimate rigidity to the canopy structure.

OPTIONAL EXTRAS:

- › Secure roller shutters
- › Side panels
- › Rainbow package
- › Post pads
- › Signage
- › Gable ends

See pages 48-49

USES:

- › Outdoor classroom
- › Covered outdoor dining area
- › Covered outdoor walkway
- › Entrance canopy

Please note: Images show gable ends which are an optional extra.



Welford Dome Junior

Steel Dome Canopies



Residential



Education



Hospitality
& Leisure



Retail &
Commercial



Healthcare

The Welford Dome Junior is a cost-effective free standing canopy structure which is extremely versatile and ideal for many uses such as a covered waiting or dining area.

Based on the popular Welford Dome, the Welford Dome Junior has been streamlined to suit organisations that have limited budgets yet still require effective and durable outdoor cover from the weather.

Features and Benefits

25 YEAR LIFE EXPECTANCY:

Life expectancy of up to 25 years, subject to the chosen finish.

SIZE: To your specification.

Length: Unlimited
Width: Up to 5 metres
Height: To your specification

FRAMEWORK FINISH:

Framework and posts can be galvanised and/ or powder coated to any standard RAL colour.

STEEL UNDERSIDE FRAME AND POSTS:

Main frame: 60mm x 60mm x 3mm steel box section.

PANELS:

5mm solid or 16mm structured vandal and shatter resistant polycarbonate with built in UV protection. Available in clear or opal.

ROOF FRAME:

Steel roof frame, including steel roof bars and aluminium rafter bars. The steel bars are coloured in any standard RAL colour, other colours available on request and the aluminium bars are coloured in Hipca White as standard, other colours are available at an additional cost.

OPTIONAL EXTRAS:

- > Rainbow package
 - > Post pads
 - > Side panels
- See pages 48-49*
- > Guttering
 - > Downpipes

USES:

- > Playground canopy
- > Outdoor classroom
- > Covered outdoor dining area
- > Covered outdoor walkway



Devoke

Steel Canopies



Residential



Education



Hospitality
& Leisure



Retail &
Commercial



Healthcare

The Devoke Free Standing Canopy is a striking steel structure that has a stylish curved roof.

This free standing canopy provides shelter from the sun and rain throughout the year and can be constructed to any length with a maximum projection of 6 metres. The Devoke is ideal for educational environments, creating a comfortable outdoor dining area or a spacious playground shelter.

Features and Benefits

25 YEAR LIFE EXPECTANCY:

Life expectancy of up to 25 years, subject to the chosen finish.

SIZE: To your specification.

Length: Unlimited
Width: Up to 6 metres
Height: To your specification

FRAMEWORK FINISH:

The steel framework can be galvanised and/or powder coated to any standard RAL colour.

STEEL UNDERSIDE FRAME AND POSTS:

Main frame: 120mm x 60mm x 3mm steel hollow section.

PANELS:

5mm solid or 16mm structured vandal and shatter resistant polycarbonate roofing UV coated for high protection from the sun.

GUTTERING & DOWNPIPES:

Deep flow guttering and uPVC downpipes fitted as standard

ROOF FRAME:

Steel roof frame, including steel roof bars and aluminium rafter bars. The steel bars are coloured in any standard RAL colour, other colours available on request and the aluminium bars are coloured in Hipca White as standard, other colours are available at an additional cost.

UNIQUE CORNER STRUCTURE:

Our unique steel corner connection system gives ultimate rigidity to the canopy structure.

OPTIONAL EXTRAS:

- › Secure roller shutters
- › Side panels
- › Rainbow package
- › Post pads
- › Signage

See pages 48-49

USES:

- › Playground canopy
- › Outdoor classroom
- › Airport shelter/link way
- › Covered outdoor dining/seating area
- › Covered outdoor walkway



Devoke Junior

Steel Canopies



Residential



Education



Hospitality
& Leisure



Retail &
Commercial



Healthcare

The Devoke Junior Free Standing Canopy is a contemporary structure which features a strong steel framework and polycarbonate roof panels to create effective cover ideal for outdoor dining and play areas. This stylish canopy is part of our Junior range; a selection of products which have been designed for organisations with limited budgets, yet who still require a high quality and long lasting structure.

This popular canopy allows you to connect two or more buildings - giving visitors, students or staff the advantage of moving around your site without being exposed to the elements, it can also allow free-flow from the inside to the outside whilst keeping protected from the weather.

Features and Benefits

25 YEAR LIFE EXPECTANCY:

Life expectancy of up to 25 years, subject to the chosen finish.

SIZE: To your specification.

Length: Unlimited
Width: Up to 5 metres
Height: To your specification

FRAMEWORK FINISH:

The steel framework can be galvanised and/or powder coated to any standard RAL colour.

STEEL UNDERSIDE FRAME AND POSTS:

Main frame: 60mm x 60mm x 3mm steel hollow section.

PANELS:

Choice of 5mm solid or 16mm structured polycarbonate roof which is both vandal and shatter resistant and offers high UV protection.

ROOF FRAME:

Steel roof frame, including steel roof bars and aluminium rafter bars. The steel bars are coloured in any standard RAL colour, other

colours available on request and the aluminium bars are coloured in Hipca White as standard, other colours are available at an additional cost.

OPTIONAL EXTRAS:

- > Side panels
- > Post Pads
- > Signage
- > Rainbow Package
- > Roller Shutters
- See [pages 48-49](#)
- > Guttering
- > Downpipes

USES:

- > Playground canopy
- > Outdoor classroom
- > Airport shelter/link way
- > Covered outdoor dining/seating area
- > Covered outdoor walkway



Grange

Steel Mono-Pitch Canopies



Residential



Education



Hospitality
& Leisure



Retail &
Commercial



Healthcare

The Grange Free Standing Mono-Pitch canopy is perfect for areas where a canopy structure cannot be fixed to a wall. Using the same roof system as the Coniston, which includes 35mm polycarbonate panels and a fully aluminium roof framework, the Grange's roof offers a variable pitch of between 2.5 and 30 degrees. Supported by a strong steel underside, the Grange has a maximum width of 6 metres and an unlimited length.

Due to its unlimited length and robust construction, the Grange is ideal for many organisations and is great for use as a covered meeting/waiting area or an outdoor learning area.

Features and Benefits

25 YEAR LIFE EXPECTANCY:

Life expectancy of up to 25 years, subject to the chosen finish.

SIZE: To your specification.

Length: Unlimited
Width: Up to 6 metres
Height: To your specification

UNDERSIDE FRAMEWORK FINISH:

The underside framework and posts can be galvanised and/or powder coated to any standard RAL colour.

STEEL UNDERSIDE FRAME AND POSTS:

120mm x 60mm x 3mm steel hollow section.

ROOF FRAME:

Fully aluminium roof frame, including aluminium roof bars, coloured in Hipca White as standard, other colours available on request.

PANELS:

35mm structured polycarbonate roof panels which are vandal and shatter resistant and offer high levels of UV protection.

GUTTERING & DOWNPIPES

Supplied with integral guttering and uPVC downpipes.

UNIQUE CORNER STRUCTURE:

Our unique steel corner connection system gives ultimate rigidity to the canopy structure.

OPTIONAL EXTRAS:

- > Side panels
- > Rainbow package
- > Secure roller shutters
- > Post pads
- > Signage

See pages 48-49

USES:

- > Covered waiting area
- > Meeting point
- > Playground canopy
- > Covered outdoor learning area



Grange Junior

Steel Canopies



Residential



Education



Hospitality
& Leisure



Retail &
Commercial



Healthcare

The Grange Junior is a cost-effective canopy solution that has a practical and simple design and is ideal for areas where a wall mounted canopy is unsuitable.

This canopy can span up to 5 metres and has an unlimited length allowing you to create a large covered area which can be used for many different applications including an outdoor classroom facility, a covered playground area, or an outside dining area.

Features and Benefits

25 YEAR LIFE EXPECTANCY:

Life expectancy of up to 25 years, subject to the chosen finish.

SIZE: To your specification.

Length: Unlimited
Width: Up to 5 metres
Height: To your specification

FRAMEWORK FINISH:

The framework and posts can be galvanised and/or powder coated to any standard RAL colour.

STEEL UNDERSIDE FRAME AND POSTS:

60mm x 60mm x 3mm steel hollow section.

ROOF FRAME:

Steel roof frame, including steel roof bars and aluminium rafter bars. The steel bars are coloured in any standard RAL colour, other

colours available on request and the aluminium bars are coloured in Hipca White as standard, other colours are available at an additional cost.

PANELS:

5mm solid or 16mm structured vandal and shatter resistant polycarbonate roofing, UV coated for high protection from the sun.

OPTIONAL EXTRAS:

- › Rainbow package
- › Post pads
- › Side & front fills
- See [pages 48-49](#)
- › uPVC or aluminium guttering & downpipes

USES:

- › Covered waiting area
- › Meeting point



Ullswater

Steel Apex Canopies



Residential



Education



Hospitality
& Leisure



Retail &
Commercial



Healthcare

The Ullswater Apex Free Standing Canopy has an attractive design with an apex shaped roof enabling it to fit in seamlessly with traditional building designs.

This canopy system is designed using our unique corner structure which provides ultimate strength and allows for large self-supporting spans. Its robust construction ensures this canopy is particularly suited to areas of heavy use such as school playgrounds and public areas.

Features and Benefits

25 YEAR LIFE EXPECTANCY:

Life expectancy of up to 25 years, subject to the chosen finish.

SIZE: To your specification.

Length: Unlimited
Width: Up to 6 metres
Height: 2.8m at apex (standard)

ROOF FRAME:

Fully aluminium roof frame, including aluminium roof bars, coloured in Hipca White as standard, other colours available on request.

STEEL UNDERSIDE FRAME AND POSTS:

120mm x 60mm x 3mm steel box section. The steel framework can be galvanised and/or powder coated to any standard RAL colour.

PANELS:

35mm structured polycarbonate roof panels in clear or opal. Our panels offer high UV protection.

GUTTERING:

Integral aluminium guttering with uPVC downpipes.

OPTIONAL EXTRAS:

- > Secure roller shutters
 - > Side & front panels
 - > Rainbow package
 - > Post pads
 - > Signage
- See pages 48-49
- > Gable ends

USES:

- > Playground canopy
- > Outdoor classroom
- > Covered outdoor walkway

Please note: Images show gable ends which are an optional extra



Whiteside

Steel Canopies



Residential



Education



Hospitality
& Leisure



Retail &
Commercial



Healthcare

The Whiteside Free Standing Canopy is a cost effective structure which has a stylish curved roof, allowing you to create a contemporary covered area outside.

Due to its design, this canopy can create a large sheltered area within your grounds that is protected from the weather, allowing your pupils, customers or staff to spend more time outdoors. The Whiteside can be wall mounted or free standing to suit your needs.

Features and Benefits

25 YEAR LIFE EXPECTANCY:

The Whiteside has a life expectancy of up to 25 years, subject to the chosen finish, giving you peace of mind that our products are made to last.

SIZE: To your specification.

Length: Unlimited
Projection: Up to 4 metres

STEEL FRAME:

The frame is made from steel which can be galvanised, please see below for finish options.

FRAMEWORK FINISH:

The steel framework can be galvanised and/or powder coated to any standard RAL colour.

PANELS:

Covered with a choice of 5mm solid polycarbonate or 16mm structured polycarbonate.

ROOF FRAME:

Steel roof frame, including steel roof bars and aluminium rafter bars. The steel bars are coloured in any standard RAL colour, other colours available on request and the aluminium bars are coloured in Hipca White as standard, other colours are available at an additional cost.

OPTIONAL EXTRAS:

- > Side panels
- > Post Pads
- See pages 48-49
- > Guttering
- > Downpipes

USES:

- > Free standing canopy
- > Entrance canopy
- > Outside dining canopy
- > Playground canopy
- > Waiting shelter



Kensington Mono-Pitch

Steel Canopies



Education



Retail & Commercial



Healthcare

The Kensington Mono-Pitch Free Standing Canopy features a stunning steel design which is covered with a choice of glass, polycarbonate or solar panels which allow you to generate energy from sunlight whilst giving a smooth glass finish.

The Kensington Mono-Pitch Free Standing Canopy is particularly suited to the retail and hospitality sectors, and is perfect for organisations looking to provide a high end shelter solution.

Features and Benefits

25 YEAR LIFE EXPECTANCY:

Life expectancy of up to 25 years, subject to the chosen finish.

SIZE: To your specification.

Length: Unlimited
Width: Up to 3 metres
Height: To your specification

FRAMEWORK FINISH:

The steel framework can be galvanised and/or powder coated to any standard RAL colour.

STEEL UNDERSIDE FRAME & POSTS:

Main frame: 200mm x 200mm x 6mm steel box section.

ROOF FRAME:

Steel roof frame, including steel roof bars and aluminium rafter bars. The steel bars are coloured in any standard RAL colour, other colours available on request and the aluminium bars are coloured in Hipca White as standard, other colours are available at an additional cost.

PANELS:

A choice of:
 > 10.8mm toughened laminated glass
 > 16mm structured vandal and shatter resistant polycarbonate
 > Solar Panels - Integrated Photovoltaic (IPV) glass solar panels.

GUTTERING:

Fitted with aluminium guttering and downpipes as standard.

OPTIONAL EXTRAS:

> Post pads
 See pages 48-49

USES:

> Entrance canopy
 > Covered walkway
 > Airport shelter/link way



Kensington Dual-Pitch

Steel Canopies



Education



Hospitality
& Leisure



Retail &
Commercial



Healthcare

The Kensington Dual-Pitch Free Standing Canopy is a striking free standing canopy that fits in effortlessly with new builds and adds a contemporary look to existing buildings.

This canopy is ideal for a range of different functions including walkways, waiting areas and outdoor dining cover, and is suited to many organisations throughout the public and private sectors.

Features and Benefits

25 YEAR LIFE EXPECTANCY:

Life expectancy of up to 25 years, subject to the chosen finish.

SIZE: To your specification.

Length: Unlimited (6 metres between posts)
Width: Up to 5.5 metres
Height: To your specification

FRAMEWORK FINISH:

The steel framework can be galvanised and/or powder coated to any standard RAL colour.

STEEL UNDERSIDE FRAME & POSTS:

Main frame: 200mm x 200mm x 6mm steel box section.

STEEL FRAME AND POSTS:

Main frame: 150mm x 100mm x 5mm steel hollow section.

ROOF FRAME:

Steel roof frame, including steel roof bars and aluminium rafter bars. The steel bars are coloured in any standard RAL colour, other colours available on request and the aluminium bars are coloured in Hipca White

as standard, other colours are available at an additional cost.

PANELS:

A choice of:

- > 10.8mm toughened laminated glass
- > 16mm structured vandal and shatter resistant polycarbonate
- > Solar Panels - Integrated Photovoltaic (IPV) glass solar panels.

GUTTERING: Fitted with aluminium guttering and downpipes as standard.

DESIGN: Elegant, modern design; creates an aesthetically pleasing focal point to your building or outdoor area.

OPTIONAL EXTRAS:

- > Post pads
- See pages 48-49

USES:

- > Entrance canopy
- > Covered walkway
- > Airport shelter/link way



Kendal

Steel Canopies



Education



Hospitality
& Leisure



Retail &
Commercial



Healthcare

The Kendal is a striking tensile free standing structure which can be constructed to any length with a maximum projection of 5 metres.

The waterproof tensile fabric combined with the steel frame makes this a robust system which provides effective cover from the weather.

Features and Benefits

25 YEAR LIFE EXPECTANCY:

The Kendal frame has a life expectancy of up to 25 years, giving you peace of mind that our products are made to last.

5 YEAR GUARANTEE:

Tensile fabric has a 5 year guarantee against UV degradation

SIZE: To your specification.

Length: Unlimited
Projection: Up to 5 metres

FRAMEWORK FINISH:

The steel framework can be galvanised and/or powder coated to any standard RAL colour.

ROOF:

100% waterproof tensile roof available in 40 vibrant colours, see page 125.

OPTIONAL EXTRAS:

- › Post pads
See pages 48-49
- › Fabric rear wall panels - *See page 125*

USES:

- › Covered outdoor walkway
- › Outdoor classroom
- › Waiting area

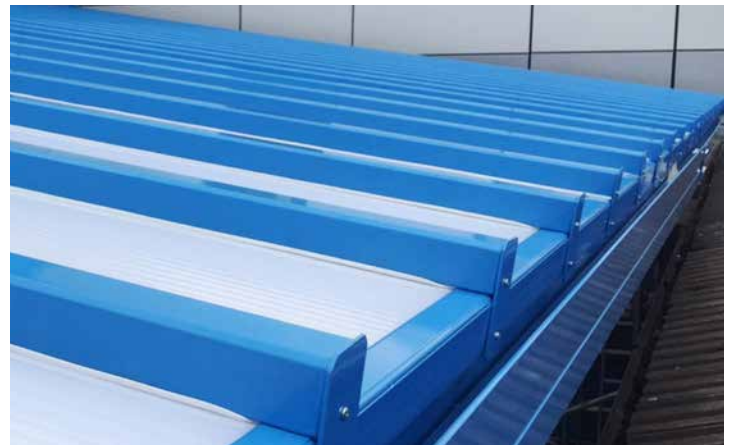





Tarnhow Free Standing Canopies

Sustainable Timber Canopies



Our Tarnhow canopies are constructed from glue-laminated Glulam timber frames to create stunning tactile structures which add a modern yet natural feel to your environment.

All Glulam timber framework is finished with a natural timber stain for added protection, however, you can choose to have your canopy stained in a wide choice of colours to match or complement your surroundings.

Benefits of Timber

- › Environmentally Friendly – a standard steel beam takes 6 times the energy cost to produce
- › Economical – Glulam is lighter in weight than similar materials resulting in less transport emissions
- › Flawless Finish - All visible structural fixings are Stainless Steel or Galvanised Steel to ensure long term defence against corrosion
- › Timber frame is fire resistant to BS 5268
- › Approved Timber - complies with the requirements of British Standard BS EN 386: 2001
- › Sustainable Materials - The Glulam timber frame is sourced from PEFC accredited timber merchants.



Tarnhow Dome

Sustainable Timber Canopies



Residential



Education



Hospitality
& Leisure



Retail &
Commercial



Healthcare

The Tarnhow Dome Free Standing Timber Canopy is a spectacular timber structure that creates an eye-catching focal point to your outdoor area with a modern touch. It is ideal for making use of large areas that are in need of year round cover from the weather.

Features and Benefits

SIZE: To your specification.

Length: Unlimited

Width: Up to 6 metres standard - see Large span on page 47 for over 6m

Height: To your specification

ROOF OPTIONS:

Choice of:

5mm solid or 16mm structured vandal and shatter resistant polycarbonate roofing UV coated for high protection from the sun.

UNDERSIDE FRAME AND POSTS:

Bespoke Glulam timber and natural timber sections, with a natural wood stain finish, alternatively the timber can be painted, if required.

GUTTERING & DOWNPIPES:

uPVC guttering & downpipes fitted as standard.

ROOF RAFTER BARS:

Aluminium rafter bars are finished in Hipca White as standard, other colours are available at an additional cost.

ROOF FRAME:

Curved Glulam timber beams available in a selection of different stains with aluminium roof bars coloured in white as standard.

OPTIONAL EXTRAS:

- > Rainbow package
- > Post pads
- > Signage

See pages 48-49

USES:

- > Play canopy
- > Medium/large freestanding canopy
- > Covered outdoor dining area
- > Covered outdoor walkway
- > Entrance canopy



Tarnhow Mono-Pitch

Sustainable Timber Canopies



Residential



Education



Hospitality
& Leisure



Retail &
Commercial



Healthcare

The Tarnhow Mono-Pitch Free Standing Canopy is constructed with a mono-pitch roof which blends in easily with existing roofing styles.

This striking timber structure can be used in a variety of applications including covered play areas, walkways and waiting areas within commercial settings.

Features and Benefits

SIZE: To your specification.

Length: Unlimited
Width: Up to 7.5 metres
Height: To your specification

ROOF OPTIONS:

Choice of:
5mm solid or 16mm structured vandal and shatter resistant polycarbonate roofing

UNDERSIDE FRAME AND POSTS:

Bespoke Glulam timber and natural timber sections, with a natural wood stain finish, alternatively the timber can be painted, if required.

GUTTERING & DOWNPIPES

uPVC guttering & downpipes fitted as standard.

ROOF RAFTER BARS:

Aluminium rafter bars are finished in Hipca White as standard, other colours are available at an additional cost.

ROOF FRAME:

Curved Glulam timber beams available in a selection of different stains with aluminium roof bars coloured in white as standard.

OPTIONAL EXTRAS:

- > Rainbow package
 - > Post pads
 - > Signage
- See pages 48-49

USES:

- > Play canopy
- > Medium/large freestanding canopy
- > Covered outdoor dining area
- > Covered outdoor walkway
- > Entrance canopy



Tarnhow Curved

Sustainable Timber Canopies



Residential



Education



Hospitality
& Leisure



Retail &
Commercial



Healthcare

The Tarnhow Curved Free Standing Canopy has a maximum span of 7.5 metres and can be installed to any length required. Its asymmetric curved roof creates an attractive canopy which adds style to any environment, and its Glulam frame makes this canopy an ideal addition to a natural garden or park area.

This canopy is very popular with schools and is suitable for a variety of applications, including a covered walkway, a playground shelter or a spacious outdoor classroom.

Features and Benefits

SIZE: To your specification.
Length: Unlimited
Width: Up to 7.5 metres
Height: To your specification

ROOF OPTIONS:
 Choice of:
 5mm solid or 16mm structured vandal and shatter resistant polycarbonate roofing.

UNDERSIDE FRAME AND POSTS:
 Bespoke Glulam timber and natural timber sections, with a natural wood stain finish, alternatively the timber can be painted, if required.

GUTTERING & DOWNPIPES
 uPVC guttering & downpipes fitted as standard.

ROOF RAFTER BARS:
 Aluminium rafter bars are finished in Hipca White as standard, other colours are available at an additional cost.

ROOF FRAME:
 Curved Glulam timber beams available in a selection of different stains with aluminium roof bars coloured in white as standard.

OPTIONAL EXTRAS:
 > Rainbow package
 > Post pads
 > Signage
 See pages 48-49

USES:
 > Play canopy
 > Medium/large freestanding canopy
 > Covered outdoor dining area
 > Covered outdoor walkway
 > Entrance canopy

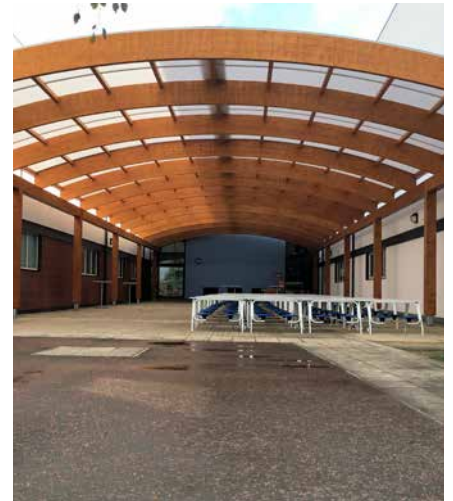

Large Span Canopy Range



Education



Hospitality
& Leisure



Retail &
Commercial



Healthcare

Our large span canopy range consists of the Hamilton, the Double Grange and the Tarnhow Dome canopies, all of which are free standing structures that have unlimited lengths and various span capability.

They are perfect for schools, sports clubs and venues that are looking to provide cover from the weather to much larger areas for outdoor events and sporting activities all year round.

Benefits of Large Span Canopies

- › **Events will no longer be rained off -**
If you use your outside area for events, a large span canopy will ensure your events go ahead whatever the weather, keeping spectators and participants dry and sheltered.
- › **Get more from your outside area -**
Transform your outside area so it's suitable for many applications such as outdoor gyms, events, function rooms, sports halls and much more, saving your inside building space for other uses and keeping visitors away from your main building for security reasons.
- › **A cost-effective way to extend your building -** Add a useable to space to your setting without the high costs of an extension. Side fills can be added to enclose the canopy for added protection.

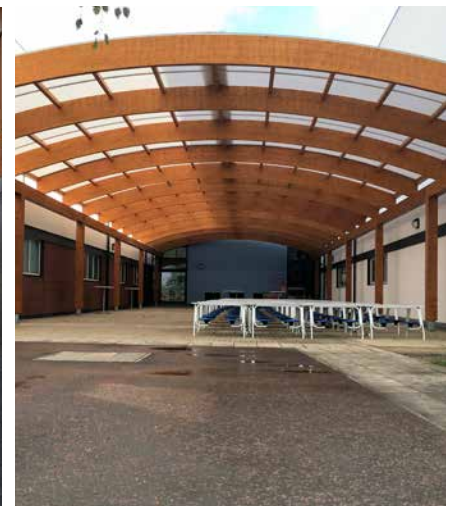

Tarnhow Dome

Large Span Canopies



Education



Hospitality
& Leisure



Retail &
Commercial



Healthcare

The Tarnhow Dome Canopy is an attractive free standing dome system that creates an eye-catching focal point to your outdoor area. Its distinctive timber framework adds a modern touch to any environment and is ideal for making use of large areas that are currently under used, especially during wet weather due to its ability to span up to 11m wide and any length.

With the Tarnhow Dome Large Span Canopy, you will be able to provide your pupils or visitors with a comfortable and spacious area which is sheltered from the weather throughout the whole year. This canopy is perfect for creating outdoor dining areas, playground shelter and sports and events shelter.

The Tarnhow Dome Free Standing Canopy is constructed from a Glulam timber frame which is PEFC certified, sustainable, fire resistant to BS 5268 and environmentally friendly.

Features and Benefits

SIZE: To your specification.

Length: Unlimited
Width: Up to 11 metres
Height: To your specification

ROOF OPTIONS:

Choice of:
5mm solid or 16mm structured vandal and shatter resistant polycarbonate roofing UV coated for high protection from the sun.

UNDERSIDE FRAME AND POSTS:

Bespoke Glulam timber and natural timber sections, with a natural wood stain finish, alternatively the timber can be painted, if required.

GUTTERING & DOWNPIPES

uPVC guttering & downpipes fitted as standard.

ROOF RAFTER BARS:

Aluminium rafter bars are finished in Hipca White as standard, other colours are available at an additional cost.

OPTIONAL EXTRAS:

- > Rainbow package
 - > Post pads
 - > Signage
- See pages 48-49

USES:

- > Large Play canopy
- > Large freestanding canopy
- > Alfresco dining canopy
- > Sports shelter
- > Events canopy



Double Grange

Large Span Canopies



Education



Hospitality
& Leisure



Retail &
Commercial



Healthcare

The Double Grange is a large span free standing canopy which is designed to provide shade and shelter from the weather over large areas.

It is an adaption of the Grange Mono-Pitch Free Standing Canopy and maintains all the benefits of the Grange, yet it has the ability to cover larger areas with a maximum span of 12 metres. This makes it ideal for event venues, large play areas, and outdoor learning areas.

Features and Benefits

25 YEAR LIFE EXPECTANCY:

Life expectancy of up to 25 years, subject to the chosen finish.

SIZE: To your specification.

Length: Unlimited
Width: Up to 12 metres
Height: To your specification

UNDERSIDE FRAMEWORK FINISH:

The underside framework and posts can be galvanised and/or powder coated to any standard RAL colour.

STEEL UNDERSIDE FRAME AND POSTS:

120mm x 60mm x 3mm steel hollow section.

ROOF FRAME:

Fully aluminium roof frame, including aluminium roof bars, coloured in Hipca White as standard, other colours available on request.

PANELS:

35mm structured polycarbonate roof panels which are vandal and shatter resistant and offer high levels of UV protection.

GUTTERING & DOWNPIPES

Supplied with integral guttering and uPVC downpipes as standard

UNIQUE CORNER STRUCTURE:

Our unique steel corner connection system gives ultimate rigidity to the canopy structure.

OPTIONAL EXTRAS:

- > Side panels
- > Rainbow package
- > Secure roller shutters
- > Post pads
- > Signage

See pages 48-49

USES:

- > Event venues
- > Covered outdoor learning areas



Hamilton

Large Span Canopies



Education



Hospitality
& Leisure



Retail &
Commercial



Healthcare

The Hamilton Big Span Canopy is one of our largest free standing canopies, spanning up to 11 metres in width, with an unlimited length. It provides exceptional cover from the weather and is perfect for providing shelter for large outdoor dining areas or open air seating areas.

The Hamilton is also a great solution for playgrounds or venues which hold outdoor events.

This big span canopy has been designed for use in busy areas with a high footfall, such as school playgrounds or large open air venues, and so has been constructed to withstand knocks and every day wear and tear.

Features and Benefits

25 YEAR LIFE EXPECTANCY:

Life expectancy of up to 25 years, subject to the chosen finish.

SIZE: To your specification.

Length: Unlimited
Width: Up to 11 metres
Height: To your specification

HIGH UV PROTECTION:

During the manufacture of our polycarbonate panels, a layer of UV absorber is co-extruded on both sides to form a barrier, giving high UV protection from the sun.

FRAMEWORK FINISH:

The steel framework can be galvanised and/or powder coated to any standard RAL colour.

STEEL FRAME AND POSTS:

Main frame: 150mm x 100mm x 5mm steel hollow section.

ROOF FRAME:

Steel roof frame, including steel roof bars and aluminium rafter bars. The steel bars are coloured in any standard RAL colour, other

colours available on request and the aluminium bars are coloured in Hipca White as standard, other colours are available at an additional cost.

PANELS:

16mm structured vandal and shatter resistant polycarbonate roofing.

GUTTERING:

uPVC guttering and downpipes included as standard.

OPTIONAL EXTRAS:

- › Secure roller shutters
- › Side panels
- › Rainbow package
- › Post pads
- › Signage

See pages 48-49

USES:

- › Covered outdoor dining area
- › Outdoor event cover
- › Outdoor seating cover
- › Courtyard cover



The Coniston

Aluminium Canopies



Residential



Education



Hospitality
& Leisure



Retail &
Commercial



Healthcare

The Coniston Wall Mounted Canopy which can be found on pages 10-14 can be transformed into a free standing canopy with the use of rear steel or aluminium goal posts.

The Coniston is a popular, versatile canopy that is strong, long lasting and aesthetically pleasing. It features a strong aluminium frame with rear steel/aluminium posts and hidden integral guttering.

It is ideal for those that would like a wall mounted canopy but do not have a suitable wall to fix to. This canopy gives the wall mounted canopy effect whilst being completely self-supporting.

Features and Benefits

10 YEAR GUARANTEE:

The Coniston carries a full 10 year insurance backed guarantee and the rear steel goal posts carry a 5 year guarantee so you can rest assured that your canopy is of the highest quality.

25 YEAR LIFE EXPECTANCY:

The Coniston on rear steel/aluminium goalposts has a life expectancy of up to 25 years, giving you peace of mind that our products are made to last.

SIZE: To your specification.

Length: Unlimited
Projection: Up to 6m

FRAMEWORK FINISH:

The framework is supplied powder coated in Hipca White as standard, however it can be finished in any other RAL colour at an additional cost.

ALUMINIUM FRAME:

The frame is manufactured from T5 grade aluminium to ensure a long lasting, solid construction. The goal posts are available in a choice of steel or aluminium.

PANELS:

Covered with 35mm structured polycarbonate roof panels that are vandal and shatter resistant and block in excess of 98% of harmful UV rays from those underneath.

INTEGRAL GUTTERING:

Integral aluminium guttering is included as standard for a clean, sleek appearance and for minimal maintenance. With uPVC downpipes as standard.

OPTIONAL EXTRAS:

- › Rainbow Package
- › Secure Roller Shutters
- › The Victorian Upgrade
- › Side & Front Fills
- › Signage
- › Post Pads

See pages 48-49

USES:

- › Playground canopy
- › Covered waiting & learning areas
- › Entrance area
- › To reduce heat inside buildings

Secure Roller Shutters

Many of our wall mounted and free standing canopies can be fitted with secure roller shutters to create a safe and lockable storage area, a more enclosed canopy structure, or provide added security to your building.

These shutters are particularly suited to schools and early years settings as during the day the canopy can be used for its main purpose, and by night or during school holidays it can be used as a handy storage area. Available in steel or aluminium, they can be powder coated in any BS or RAL colour. Our secure roller shutters are supplied with a 1 year guarantee.

Signage

Signage can be added to most of our free standing and wall mounted canopies. It allows you to easily direct staff, pupils and visitors to the correct areas for convenience and safety, whilst also avoiding people entering unauthorised areas.

Wording and/or images such as logos can be added to the sign to create a welcoming entrance effect to your building.



Roller Shutters



Front Signage



Optional Extras

For Wall Mounted and Free Standing Canopies

Polycarbonate Side and Front Fills

Able Canopies side and front fills give maximum protection from the weather and are ideal for sectioning off a walkway or providing a more enclosed area. They are available with our wall mounted canopies and a selection of free standing canopies.

Our Side and Front Fills are constructed from 5mm solid polycarbonate and are UV, vandal, shatter and fire resistant.



Poly Front Fills



Poly Side Fills

The Victorian Upgrade

The Victorian Upgrade transforms the Coniston Wall Mounted Canopy range into ornate Victorian styled canopies which fit perfectly with older and traditional styled buildings.

The upgrade consists of decorative post coverings and brackets which are manufactured from high grade aluminium to create a stunning appearance that will add an extra design element to your canopy.



Victorian Upgrade

Post Pads

Our Post Pads are available in 15 different colours including yellow, bright orange, black, blue, purple, red and green and can be made to fit any size posts.

They are available to buy online in two standard sizes to fit 80mm x 80mm and 175mm x 80mm posts.

Bespoke sizes can be ordered by calling 0800 389 9072. Post Pads are also included as part of our Rainbow Package, allowing you to create a colourful and vibrant canopy ideal for Early Years settings.

Colour options



The Rainbow Package

The Able Rainbow Package will brighten up any canopy structure and is very popular within primary schools, pre-schools, nurseries and children's centres. It is a great addition for Early Years educational environments, adding colour to your setting and creating a more welcoming and child friendly atmosphere where children will love to play and learn.

This package can be added to our wall mounted canopies and a selection of our free standing canopies.



Optional Extras

For Wall Mounted and Free Standing Canopies

Coloured Polycarbonate Roof Panels

Transform your canopy into a bright, vibrant structure with our coloured polycarbonate roof panel upgrade.

This upgrade is particularly suitable for those in the Early Years and Primary Education sectors, they also work wonderfully in children's hospitals and play/activity centres as they will brighten up your outside area, making it a child friendly and fun environment.

PVC Rainbow Curtains

PVC Rainbow Curtains are the perfect accessory for school and nursery canopies and for those that want to add additional weather protection whilst still having an open canopy.

These bright and colourful PVC curtains will offer additional protection from wind and rain, whilst also allowing air flow and keeping a more open feel compared to solid side panels.

They can also be installed in your building's doorway that leads to your canopy, to create a free-flow play area.



03

We offer cost effective covered walkways to suit all locations, from universities to shopping arcades, giving your customers or students a safe and dry walk between buildings.

Walkways

Ullswater
Coniston
Welford
Welford Junior
Ennerdale Junior
Devoke Junior
Grange
Grange Junior







Ullswater

Free Standing Apex Walkways



Education



Hospitality
& Leisure



Retail &
Commercial



Healthcare

The Ullswater walkway system is completely modular in design, allowing it to be constructed to any length, enabling you to provide covered walkways of any size. The Ullswater is one of our most flexible free standing walkways, with the ability to turn corners and it can be fitted over areas of varying ground levels.

Features and Benefits

25 YEAR LIFE EXPECTANCY:

Life expectancy of up to 25 years, subject to the chosen finish.

SIZE: To your specification.

Length: Unlimited
Width: Up to 6 metres
Height: 2.8m at apex (standard)

ROOF FRAME:

Fully aluminium roof frame, including aluminium roof bars, coloured in Hipca White as standard, other colours available on request.

STEEL UNDERSIDE FRAME AND POSTS:

120mm x 60mm x 3mm steel box section. The steel framework can be galvanised and/or powder coated to any standard RAL colour.

FRAMEWORK FINISH:

The roof frame is finished in Hipca White as standard, other colours are available at an additional cost. The steel posts are available in any standard RAL colour, non-standard RAL colours may incur additional costs.

PANELS:

35mm structured polycarbonate roof panels in clear or opal. Our panels offer high UV protection.

GUTTERING:

Integral aluminium guttering with uPVC downpipes.

OPTIONAL EXTRAS:

- > Secure roller shutters
 - > Side panels
 - > Rainbow package
 - > Post pads
 - > Signage
- See pages 48-49
- > Gable ends

USES:

- > Covered outdoor walkway
- > Playground canopy
- > Medium/large free standing canopy
- > Covered outdoor dining area
- > Entrance canopy

Please note: Images show gable ends which are an optional extra



Coniston

Wall Mounted Walkways



Residential



Education



Hospitality
& Leisure



Retail &
Commercial



Healthcare

The Coniston Wall Mounted Walkway is the most versatile walkway in our range. Due to its design, the Coniston can be constructed to any length and can even be constructed to fix around corners, or wrap around the shape of your building, making it an ideal walkway solution.

Due to its wall mounted design, the Coniston is ideal for creating a walkway which extends around the exterior of your building, creating continuous shelter that connects all entrance and exit points.

The Coniston can also be transformed into a free standing walkway with the addition of steel or aluminium goal posts.

For more information about the Coniston see pages 10-15.

Features and Benefits

10 YEAR GUARANTEE:

The Coniston carries a full 10 year insurance backed guarantee and the rear steel goal posts carry a 5 year guarantee so you can rest assured that your canopy is of the highest quality.

25 YEAR LIFE EXPECTANCY:

The Coniston on rear steel goalposts has a life expectancy of up to 25 years, giving you peace of mind that our products are made to last.

SIZE: To your specification.

Length: Unlimited
Width: Up to 6 metres

ROOF FRAME:

Fully aluminium roof frame, including aluminium roof bars, coloured in Hipca White as standard, other colours available on request.

ALUMINIUM FRAME:

The frame is manufactured from T5 grade aluminium to ensure a long lasting, solid construction.

FRAMEWORK FINISH:

The aluminium frame is finished in Hipca White as standard, other colours are available at an additional cost.

GOAL POSTS: Available as a wall mounted walkway as standard, or a free standing walkway with the addition of rear steel or aluminium goal posts.

PANELS: Covered with 35mm structured polycarbonate roof panels that are vandal and shatter resistant and block in excess of 98% of harmful UV rays from those underneath.

GUTTERING: Integral aluminium guttering with uPVC downpipes.

OPTIONAL EXTRAS:

- › Secure roller shutters or side panels
 - › Rainbow package
 - › The Victorian upgrade
 - › Post pads
 - › Signage
- See pages 48-49*
- › Gable ends

USES:

- › Covered outdoor walkway or dining area
- › Playground or Entrance canopy
- › Medium/large free standing canopy



Welford Dome

Free Standing Dome Walkways



Education



Hospitality
& Leisure



Retail &
Commercial



Healthcare

The Welford Dome Walkway is an exceptionally versatile canopy system which can be used as a walkway, entrance canopy or a free standing canopy.

Ideal for all commercial settings, the Welford Walkway can be constructed to any length with a width of up to 6 metres, giving you superb cover from building to building.

Features and Benefits

25 YEAR LIFE EXPECTANCY:

Life expectancy of up to 25 years, subject to the chosen finish.

SIZE: To your specification.

Length: Unlimited
Width: Up to 6 metres
Height: To your specification

ROOF FRAME:

Steel roof frame, including steel roof bars, coloured in any standard RAL colour, other colours available on request.

STEEL UNDERSIDE FRAME AND POSTS:

Main frame: 120mm x 60mm x 3mm steel box section.

FRAMEWORK FINISH:

Framework and posts can be galvanised and/ or powder coated to any standard RAL colour.

PANELS:

5mm solid or 16mm structured vandal and shatter resistant polycarbonate with built in UV protection. Available in clear or opal.

ROOF RAFTER BARS:

Aluminium rafter bars are finished in Hipca White as standard, other colours are available at an additional cost.

GUTTERING:

Guttering and uPVC downpipes fitted as standard.

OPTIONAL EXTRAS:

- > Secure roller shutters
- > Side panels
- > Rainbow package
- > Post pads
- > Signage

See pages 48-49

USES:

- > Covered outdoor walkway
- > Outdoor classroom
- > Waiting canopy
- > Covered outdoor dining area
- > Entrance canopy



Welford Dome Junior

Free Standing Dome Walkways



Education



Hospitality
& Leisure



Retail &
Commercial



Healthcare

The Welford Junior Walkway can be constructed to any length to create a stylish covered walkway and has a maximum width of 5 metres. It has a strong steel framework and is covered with a choice of 5mm solid or 16mm structured polycarbonate roof panels.

As one of our most cost effective walkways, the Welford Junior is ideal for organisations who have limited funds, yet require a high quality covered walkway solution.

Features and Benefits

25 YEAR LIFE EXPECTANCY:

Life expectancy of up to 25 years, subject to the chosen finish.

SIZE: To your specification.

Length: Unlimited
Width: Up to 5 metres
Height: To your specification

ROOF FRAME:

Steel roof frame, including steel roof bars, coloured in any standard RAL colour, other colours available on request.

STEEL UNDERSIDE FRAME AND POSTS:

Main frame: 60mm x 60mm x 3mm steel box section

FRAMEWORK FINISH:

Framework and posts can be galvanised and/ or powder coated to any standard RAL colour.

PANELS:

5mm solid or 16mm structured vandal and shatter resistant polycarbonate with built in UV protection. Available in clear or opal.

ROOF RAFTER BARS:

Aluminium rafter bars are finished in Hipca White as standard, other colours are available at an additional cost.

OPTIONAL EXTRAS:

- > Side panels
 - > Rainbow package
 - > Post pads
- See pages 48-49
- > Guttering

USES:

- > Covered outdoor walkway
- > Outdoor classroom
- > Waiting canopy
- > Covered outdoor dining area



Ennerdale Junior

Cantilever Walkways



Education



Hospitality
& Leisure



Retail &
Commercial



Healthcare

The Ennerdale Junior is a cost-effective cantilever walkway system that is modular in design, allowing the walkway to be easily extended at any time.

Ideal for schools and commercial settings, this canopy offers stylish aesthetics and effective cover for organisations with smaller budgets.

Features and Benefits

25 YEAR LIFE EXPECTANCY:

Life expectancy of up to 25 years, subject to the chosen finish.

SIZE: To your specification.

Length: Unlimited
Width: Up to 5 metres
Height: To your specification

ROOF FRAME:

Steel roof frame, including steel roof bars, coloured in any standard RAL colour, other colours available on request.

STEEL UNDERSIDE FRAME AND POSTS:

Main frame: 60mm x 60mm x 6mm steel box section.

FRAMEWORK FINISH:

Framework and posts can be galvanised and/or powder coated to any standard RAL colour.

PANELS:

5mm solid or 16mm structured vandal and shatter resistant polycarbonate with built in UV protection. Available in clear or opal.

ROOF RAFTER BARS:

Aluminium rafter bars are finished in Hipca White as standard, other colours are available at an additional cost.

OPTIONAL EXTRAS:

- > Side panels
 - > Rainbow package
 - > Post pads
 - > Signage
 - > Roller shutters
- See *pages 48-49*

USES:

- > Covered outdoor walkway
- > Freestanding canopy
- > Waiting canopy



Devoke Junior

Free Standing Walkways



Education



Hospitality
& Leisure



Retail &
Commercial



Healthcare

The Devoke Junior Free Standing Walkway is a contemporary styled walkway which features a strong steel framework and polycarbonate roofing panels to create effective cover for walkways or pathways. This walkway product is part of our Junior range, a selection of products which have been designed for organisations with limited budgets, yet who still require a high quality and long lasting structure.

This popular walkway canopy allows you to connect two or more buildings - giving visitors, students or staff the advantage of moving around your site without being exposed to the elements. It can also double as a covered waiting/queuing area which is particularly useful at entrances to tourist attractions.

Features and Benefits

25 YEAR LIFE EXPECTANCY:

Life expectancy of up to 25 years, subject to the chosen finish.

SIZE: To your specification.

Length: Unlimited
Width: Up to 5 metres
Height: To your specification

ROOF FRAME:

Steel roof frame, including steel roof bars, coloured in any standard RAL colour, other colours available on request.

STEEL UNDERSIDE FRAME AND POSTS:

Main frame: 60mm x 60mm x 3mm steel box section.

FRAMEWORK FINISH:

Framework and posts can be galvanised and/ or powder coated to any standard RAL colour.

PANELS:

5mm solid or 16mm structured vandal and shatter resistant polycarbonate with built in UV protection. Available in clear or opal.

ROOF RAFTER BARS:

Aluminium rafter bars are finished in Hipca White as standard, other colours are available at an additional cost.

OPTIONAL EXTRAS:

- > Side panels
 - > Rainbow package
 - > Post pads
 - > Signage
 - > Roller shutters
- See [pages 48-49](#)
- > Guttering

USES:

- > Covered outdoor walkway
- > Freestanding canopy
- > Waiting canopy



Grange

Free Standing Walkways



Residential



Education



Hospitality
& Leisure



Retail &
Commercial



Healthcare

The Grange free standing walkway canopy is a stylish mono-pitch structure that is ideal for installation adjacent to walls, where wall mounted installation is not suitable.

Using the same roof system as the Coniston, which includes 35mm polycarbonate panels and a fully aluminium roof frame, the Grange offers a variable roof pitch of between 2.5 and 30 degrees.

Supported by a strong steel underside, the Grange has a maximum width of 6 metres and an unlimited length.

Due to its unlimited length and robust construction, the Grange is ideal for many organisations and is great for use as a covered walkway as well as a sheltered waiting/pick up point.

Features and Benefits

25 YEAR LIFE EXPECTANCY:

Life expectancy of up to 25 years, subject to the chosen finish.

SIZE: To your specification.

Length: Unlimited
Width: Up to 6 metres
Height: To your specification

ROOF FRAME:

Fully aluminium roof frame, including aluminium roof bars, coloured in Hipca White as standard, other colours available on request.

STEEL UNDERSIDE FRAME AND POSTS:

120mm x 60mm x 3mm steel box section. The steel framework can be galvanised and/or powder coated to any standard RAL colour.

FRAMEWORK FINISH:

The roof frame is finished in Hipca White as standard, other colours are available at an additional cost. The steel posts are available in any standard RAL colour, non-standard RAL colours may incur additional costs.

PANELS:

35mm structured polycarbonate roof panels in clear or opal. Our panels offer high UV protection.

GUTTERING:

Integral aluminium guttering with uPVC downpipes.

OPTIONAL EXTRAS:

- > Secure roller shutters
- > Side panels
- > Rainbow package
- > Post pads
- > Signage

See pages 48-49

USES:

- > Covered outdoor walkway
- > Playground canopy
- > Waiting area and pick up point
- > Covered outdoor dining area



Grange Junior

Free Standing Walkways



Residential



Education



Hospitality
& Leisure



Retail &
Commercial



Healthcare

The Grange Junior is a cost-effective covered walkway solution that has a practical and simple design and is perfect for areas where a wall mounted canopy is unsuitable. It is ideal for many sectors including education, contractors, architects, specifiers, healthcare and leisure.

It can span up to 5 metres and has an unlimited length, enabling you to cover large walkways in many different settings.

The main frame is constructed from steel and is covered with a choice of 5mm solid or 16mm structured polycarbonate roof panels and provides extensive shelter from the rain and effective cover from the sun by blocking over 98% of harmful UV rays whilst still letting through the light.

Features and Benefits

25 YEAR LIFE EXPECTANCY:

Life expectancy of up to 25 years, subject to the chosen finish.

SIZE: To your specification.

Length: Unlimited
Width: Up to 5 metres
Height: To your specification

ROOF FRAME:

Steel roof frame, including steel roof bars, coloured in any standard RAL colour, other colours available on request.

STEEL UNDERSIDE FRAME AND POSTS:

60mm x 60mm x 3mm steel hollow section.

FRAMEWORK FINISH:

The framework and posts can be galvanised and/or powder coated to any standard RAL colour.

PANELS:

5mm solid or 16mm structured vandal and shatter resistant polycarbonate roofing, UV coated for high protection from the sun.

ROOF RAFTER BARS:

Aluminium rafter bars are finished in Hipca White as standard, other colours are available at an additional cost.

OPTIONAL EXTRAS:

- > Rainbow package
 - > Post pads
- See pages 48-49
- > uPVC guttering and downpipes

USES:

- > Covered outdoor walkway
- > Playground canopy
- > Waiting area and pick up point
- > Covered outdoor dining area

04

Able Canopies offers an excellent choice of commercial entrance canopies which are ideal for many organisations such as schools, nurseries, hospitals, care homes, and retail centres.

We offer both wall mounted and free standing entrance canopies which provide attractive and welcoming entry or exit areas to help create the right first impression with customers.

All the entrance canopies in our range are constructed from robust, durable materials and have a life expectancy of up to 25 years. If required, signage can also be added to our entrance structures to display your company name or greeting message.

Entrance Canopies

Ullswater
Beck
Kensington Senior
Kensington Junior
Whiteside
Welford Dome
Ainsley
Orwell
Earlwood
Redford

Abberton
Ferndale
Tintern
Tamworth
Balmoral
Lexden
Fenwick
Nelson
Tenby
Colwyn







Ullswater

Entrance Canopies



Residential



Education



Hospitality
& Leisure



Retail &
Commercial



Healthcare

The Ullswater Entrance Canopy is a traditional free standing entrance canopy which is fitted with a unique corner system for ultimate rigidity. It is supplied in white as standard or can be finished in any standard RAL colour.

The Ullswater creates a classic entrance canopy which works particularly well with existing buildings and is very popular with healthcare organisations.

Features and Benefits

25 YEAR LIFE EXPECTANCY:

Our canopies have a life expectancy of up to 25 years, subject to the chosen finish.

SIZE: To your specification.

Length: Unlimited
Projection: Up to 6 metres
Height: To your specification

UNDERSIDE FRAMEWORK FINISH:

The steel framework can be galvanised and/or powder coated to any standard RAL colour.

STEEL UNDERSIDE FRAME:

120mm x 60mm x 3mm steel hollow section.

PANELS:

35mm structured polycarbonate roof panels for high levels of UV protection.

GUTTERING & DOWNPIPES:

Integral aluminium guttering and uPVC downpipe

ROOF FRAME:

Fully aluminium roof frame, including aluminium roof bars, coloured in Hipca White as standard, other colours available on request.

OPTIONAL EXTRAS:

- > Side panels
- > Post pads
- > Signage

See pages 48-49

USES:

- > Entrance/exit canopy
- > Meeting point
- > Waiting area



Beck

Entrance Canopies



Residential



Education



Hospitality
& Leisure



Retail &
Commercial



Healthcare

The Beck is a stylish entrance canopy that fits in perfectly with architectural and modern buildings. It has a smooth, mono pitch design with a slight pitch angle to allow for water drainage through the integral guttering.

It is fixed to the building with contemporary stainless steel tie rods that are encased within aluminium tubes for added strength and durability. This canopy also benefits from trendy perforated stainless steel brackets beneath the roof bars.

Features and Benefits

25 YEAR LIFE EXPECTANCY:

Our canopies have a life expectancy of up to 25 years, subject to the chosen finish.

SIZE: To your specification.

Length: From 1.4m - unlimited
Projection: from 1m -1.5 metres
Height: To your specification

FRAMEWORK FINISH:

The aluminium framework is supplied powder coated in a choice of 7 standard colours. Additional colours are available on request.

ALUMINIUM FRAME:

The main frame is made from high grade aluminium for strength and durability.

PANELS:

The Beck is covered with 4mm solid polycarbonate roof panels that are UV coated, have a high light transmittance and meets the fire resistance rating for the European fire standard EN 13501-1 B s1 d0 and the UK fire rating BS 476 Part 7 Class 1Y.

INTEGRAL GUTTERING:

The Beck features an integrated guttering system that disperses water through drip spouts.

LOADING CAPABILITIES:

The Beck has passed the tests undertaken by TÜV for uniformly distributed loads up to 170daN/m².

USES:

- > Entrance canopy
- > Window or walkway Canopy
- > Waiting area



Kensington Wall Mounted

Entrance Canopies



Residential



Education



Hospitality
& Leisure



Retail &
Commercial



Healthcare

The Kensington Wall Mounted Entrance Canopy is a stunning wall mounted structure that fits in effortlessly with new builds and adds a contemporary look to existing buildings. The canopy structure can be fitted with 10.8mm toughened glass panels which create a spectacular high quality finish and have great acoustic properties. Alternatively, 16mm structured polycarbonate panels are available which offer high quality, cost effective options.

You can also choose to have solar panels as your roof option. This will allow you to generate energy whilst providing stylish shade and shelter.

Features and Benefits

25 YEAR LIFE EXPECTANCY:

Life expectancy of up to 25 years, subject to the chosen finish.

SIZE: To your specification.

Length: Unlimited
Projection: Up to 2.5 metres

FRAMEWORK FINISH:

The steel framework can be galvanised and/or powder coated to any standard RAL colour.

STEEL FRAME:

100mm x 150mm steel hollow section 8mm thick steel laser cut roof arms.

ROOF RAFTER BARS:

Aluminium rafter bars are finished in Hipca White as standard, other colours are available at an additional cost.

PANELS:

Choice of:

- > 10.8mm toughened glass
- > 16mm structured polycarbonate
- > Solar panels available

USES:

- > Entrance/exit canopy
- > Meeting point
- > Wall mounted covered walkway



Kensington Junior

Entrance Canopies



Residential



Education



Hospitality
& Leisure



Retail &
Commercial



Healthcare

The Kensington Junior is a cost-effective wall mounted entrance canopy that is ideal for many sectors including hospitality and retail. As part of our Junior range, this product has been designed to provide a quality product for organisations with smaller budgets.

With a projection of up to 1.5 metres and an unlimited length, it is a perfect entrance canopy for areas with limited space, or in an area where you would prefer not to have canopy posts.

Features and Benefits

25 YEAR LIFE EXPECTANCY:

Life expectancy of up to 25 years, subject to the chosen finish.

SIZE: To your specification.

Length: Unlimited
Projection: Up to 1.5 metres

FRAMEWORK FINISH:

The steel framework can be galvanised and/or powder coated to any standard RAL colour.

STEEL FRAME:

Front beam: 60mm x 60mm x 3mm
Rear beam: 120mm x 60mm x 3mm
8mm thick steel laser cut roof arms.

ROOF RAFTER BARS:

Aluminium rafter bars are finished in Hipca White as standard, other colours are available at an additional cost.

PANELS:

- > 16mm structured polycarbonate
- > 5mm solid polycarbonate
- > 10mm toughened glass

USES:

- > Entrance/exit canopy
- > Meeting point
- > Wall mounted canopy



Whiteside

Entrance Canopies



Residential



Education



Hospitality
& Leisure



Retail &
Commercial



Healthcare

The Whiteside Entrance Canopy is a cost effective structure which has a stylish curved roof allowing you to create a contemporary entrance to a new or existing building.

Due to its design, this canopy can create a large welcoming area for customers and visitors which can also be used as a waiting shelter making it particularly useful in school environments. The Whiteside can be wall mounted or free standing to suit your needs.

Features and Benefits

25 YEAR LIFE EXPECTANCY:

Our canopies have a life expectancy of up to 25 years, subject to the chosen finish.

SIZE: To your specification.

Length: Up to 4 metres
Projection: Up to 4 metres
Height: To your specification

FRAMEWORK FINISH:

The steel framework can be galvanised and/or powder coated to any standard RAL colour.

STEEL FRAME:

89.4mm/139mm (depending on model) x 4mm.

PANELS:

5mm solid/16mm structured vandal and shatter resistant polycarbonate with built in UV protection. Available in clear or opal.

DESIGN:

Simple, contemporary design to fit in with all building styles.

ROOF FRAME:

Steel roof frame, including steel roof bars, coloured in any standard RAL colour, other colours available on request.

ROOF RAFTER BARS:

Aluminium rafter bars are finished in Hipca White as standard, other colours are available at an additional cost.

OPTIONAL EXTRAS:

- > Side panels
 - > Post pads
 - > Signage
- See pages 48-49
- > uPVC guttering & downpipes

USES:

- > Entrance/exit canopy
- > Meeting point
- > Small freestanding canopy
- > Waiting area



Welford Dome

Entrance Canopies



Residential



Education



Hospitality
& Leisure



Retail &
Commercial



Healthcare

The Welford Dome is an exceptionally versatile free standing, modular canopy system which is ideal for most environments. With its high UV protection and contemporary design, this canopy can create a stylish entrance for visitors, or provide a covered waiting area that can be used by your staff.

Features and Benefits

25 YEAR LIFE EXPECTANCY:

Our canopies have a life expectancy of up to 25 years, subject to the chosen finish.

SIZE: To your specification.

Length: Unlimited
Projection: Up to 6 metres
Height: To your specification

FRAMEWORK FINISH:

The steel framework can be galvanised and/or powder coated to any standard RAL colour.

STEEL FRAME:

120mm x 60mm x 3mm steel hollow section.

PANELS:

5mm solid/16mm structured vandal and shatter resistant polycarbonate roofing - UV coated for high protection from the sun.

DESIGN:

Domed roof to create a classic entrance area which fits in well with existing structures.

ROOF FRAME:

Steel roof frame, including steel roof bars, coloured in any standard RAL colour, other colours available on request.

ROOF RAFTER BARS:

Aluminium rafter bars are finished in Hipca White as standard, other colours are available at an additional cost.

GUTTERING & DOWNPIPES:

uPVC Guttering and downpipes supplied as standard.

OPTIONAL EXTRAS:

- > Side panels
 - > Post pads
 - > Signage
- See pages 48-49*

USES:

- > Entrance/exit canopy
- > Meeting point
- > Freestanding canopy
- > Play canopy
- > Covered outdoor dining area



Ainsley

Entrance Canopies



Residential



Education



Hospitality
& Leisure



Retail &
Commercial



Healthcare

The Ainsley Entrance Canopy will keep your entrances dry on rainy days. It is ideal for covering the entrances to your building, making them stand out to all visitors and to help keep them dry, reducing the risk of accidents due to wet, slippery floors.

The Ainsley has a stylish mono-pitch design that is constructed from strong steel that can be galvanised and powder coated and is covered with a choice of roof panels including 5mm solid polycarbonate, 16mm structured polycarbonate and 8mm toughened glass panels.

Side panels can be added to the Ainsley Entrance Canopy to offer additional weather protection and stop wind and rain blowing in which is particularly ideal if you have automatic opening electronic doors.

Features and Benefits

25 YEAR LIFE EXPECTANCY:

Our canopies have a life expectancy of up to 25 years, subject to the chosen finish.

SIZE: To your specification.

Length: Unlimited
Projection: Up to 5m

FRAMEWORK FINISH:

The framework can be finished in any RAL colour.

STEEL FRAME:

The main frame is made from galvanised steel and is powder coated in any standard RAL colour. Non-standard RAL colours are available but may incur a surcharge.

PANELS:

The Ainsley is covered with a choice of:

- > 5mm solid polycarbonate
- > 16mm structured polycarbonate
- > 8mm toughened glass

OPTIONAL EXTRAS:

- > Glass or polycarbonate side panels
- > Post pads
- > Guttering and downpipes

USES:

- > Free standing canopy
- > Entrance canopy
- > Trolley shelter
- > Waiting shelter
- > Cycle shelter
- > Smoking shelter



Orwell

Entrance Canopies



Residential



Education



Hospitality
& Leisure



Retail &
Commercial



Healthcare

The Orwell entrance canopy has a smooth, slightly curved design that provides effective cover from the weather. The minimal appearance of the canopy enables it to create a feature point of your entrance whilst still allowing it to blend in with your outside aesthetics.

As this cost effective entrance canopy is cantilevered and has no canopy posts, it is ideal for covering busy environments such as schools, shops, leisure centres and hospitals.

Features and Benefits

25 YEAR LIFE EXPECTANCY:

Our canopies have a life expectancy of up to 25 years, subject to the chosen finish.

SIZE: To your specification.

Length: 1.4m - unlimited

Projection: Up to 2.5m

FRAMEWORK FINISH:

The framework is supplied in a choice of 7 colours. Alternative colours may be available but will incur additional costs.

ALUMINIUM FRAME:

The frame is manufactured from T5 grade aluminium to ensure a long lasting, solid construction.

PANELS:

Covered with solid polycarbonate panels that are 4mm thick and are light in weight. These panels have a high impact resistance, making them ideal for use in well used areas. They are supplied in clear as standard.

INTEGRAL GUTTERING:

Integral aluminium guttering is included as standard which disperses water through a drip spout at the sides of the canopy frame.

LOADING CAPABILITIES:

The Orwell has passed the TÜV tests for uniformly distributed up to 170daN/m².

USES:

- > Entrance canopy
- > Walkway canopy
- > External stairway shelter
- > Waiting shelter



Earlswood

Entrance Canopies



Residential



Education



Hospitality
& Leisure



Retail &
Commercial

The Earlswood Entrance Canopy features a delicate curve and stunning decorative wall brackets. It will enhance the entrance of any building, and will fit in seamlessly with traditional buildings and rural settings.

As this canopy is cantilevered, it is ideal for those that would like a cost-effective door canopy with quick installation times and no canopy posts, such as shops, hospitals, schools, cafés and bars.

Features and Benefits

25 YEAR LIFE EXPECTANCY:

Our canopies have a life expectancy of up to 25 years, subject to the chosen finish.

SIZE: To your specification.

Length: 1.4m - unlimited

Projection: 0.9m – 1.5m

FRAMEWORK FINISH:

The framework is supplied in a choice of 7 colours. Alternative colours may be available but will incur additional costs.

ALUMINIUM FRAME:

The frame is manufactured from T5 grade aluminium to ensure a long lasting, solid construction.

PANELS:

Covered with solid polycarbonate panels that are 4mm thick and are light in weight. These panels have a high impact resistance, making them ideal for use in well used areas. They are supplied in clear as standard.

INTEGRAL GUTTERING:

Integral aluminium guttering is included as standard which disperses water through a drip spout at the sides of the canopy frame.

LOADING CAPABILITIES:

The Earlswood has passed the TÜV tests for uniformly distributed up to 170daN/m².

USES:

- > Entrance canopy
- > Walkway canopy
- > Waiting shelter



Redford

Entrance Canopies



Residential



Education



Hospitality
& Leisure



Retail &
Commercial



Healthcare

The extra-deep curve of the Redford Entrance Canopy, allows it to offer additional protection from the weather such as rain and wind whilst still offering high protection from the sun. It is therefore ideal for those that would like to receive full protection from the weather with a small shelter structure.

The frame is constructed from strong aluminium bars and is covered with polycarbonate roof sheets that have a high resistance to impacts.

Due to the simple, cantilevered design, this entrance canopy is ideal for weather protection at schools, hospitals, shops and those in the leisure industry.

Features and Benefits

25 YEAR LIFE EXPECTANCY:

Our canopies have a life expectancy of up to 25 years, subject to the chosen finish.

SIZE: To your specification.

Length: 1.4m - unlimited
Projection: 0.8m - 1.5m

FRAMEWORK FINISH:

The framework is supplied in a choice of 7 colours. Alternative colours are available but may incur additional costs.

ALUMINIUM FRAME:

The frame is manufactured from T5 grade aluminium to ensure a long lasting, solid construction.

PANELS:

Covered with solid polycarbonate panels that are 4mm thick and are light in weight. These panels have a high impact resistance, making them ideal for use in well used areas. They are supplied in clear as standard.

INTEGRAL GUTTERING:

Integral aluminium guttering is included as standard which disperses water through a drip spout at the sides of the canopy frame.

LOADING CAPABILITIES:

The Redford has passed the TÜV tests for uniformly distributed up to 170daN/m².

USES:

- > Entrance canopy
- > Walkway canopy
- > External stairway shelter
- > Waiting shelter





Abberton

Entrance Canopies



Residential



Education



Hospitality
& Leisure



Retail &
Commercial



Healthcare

The Abberton is a contemporary styled cantilevered entrance canopy, with perforated steel wall brackets to give an industrial appearance. The main frame is constructed from T5 grade aluminium and is covered with high impact resistant polycarbonate.

It benefits from an unlimited length (minimum of 1.4m) and has a projection of between 0.9m – 1.5m from the wall.

The Abberton's stylish design makes it ideal for many settings, particularly new builds, and healthcare or commercial buildings.



Features and Benefits

25 YEAR LIFE EXPECTANCY:

Our canopies have a life expectancy of up to 25 years, subject to the chosen finish.

SIZE: To your specification.

Length: 1.4m - unlimited

Projection: 0.9m – 1.5m

FRAMEWORK FINISH:

The framework is supplied in a choice of 7 colours. Alternative colours are available but may incur additional costs.

ALUMINIUM FRAME:

The frame is manufactured from T5 grade aluminium to ensure a long lasting, solid construction.

PANELS:

Covered with solid polycarbonate panels that are 4mm thick and are light in weight. These panels have a high impact resistance, making them ideal for use in busy areas. They are supplied in clear as standard.

INTEGRAL GUTTERING:

Integral aluminium guttering is included as standard which disperses water through a drip spout at the sides of the canopy frame.

LOADING CAPABILITIES:

The Abberton has passed the TÜV tests for uniformly distributed up to 170daN/m².

USES:

- > Entrance canopy
- > Walkway canopy
- > External stairway shelter
- > Waiting shelter



Ferndale

Entrance Canopies



Residential



Education



Hospitality
& Leisure



Retail &
Commercial



Healthcare

The Ferndale Entrance Canopy benefits from a strong curved roof design to offer enhanced protection from the weather. The roof panels are robust polycarbonate sheets that offer high UV protection, making this canopy the ultimate weather shield for entrances.

The frame is fixed to the wall with supporting aluminium arms and small brackets for an elegant, minimal appearance.

The contemporary design of this canopy makes it ideal for leisure centres and shop entrances.

Features and Benefits

25 YEAR LIFE EXPECTANCY:

Our canopies have a life expectancy of up to 25 years, subject to the chosen finish.

SIZE: To your specification.

Length: 1.4m - unlimited
Projection: 0.8m - 1.5m

FRAMEWORK FINISH:

The framework is supplied in a choice of 7 colours. Alternative colours are available but may incur additional costs.

ALUMINIUM FRAME:

The frame is manufactured from T5 grade aluminium to ensure a long lasting, solid construction.

PANELS:

Covered with solid polycarbonate panels that are 4mm thick and are light in weight. These panels have a high impact resistance, making them ideal for use in well used areas. They are supplied in clear as standard.

INTEGRAL GUTTERING:

Integral aluminium guttering is included as standard which disperses water through a drip spout at the sides of the canopy frame.

LOADING CAPABILITIES:

The Ferndale has passed the TÜV tests for uniformly distributed up to 170daN/m².

USES:

- > Entrance canopy
- > Walkway canopy
- > Waiting shelter





Tintern

Entrance Canopies



Residential



Education



Hospitality
& Leisure



Retail &
Commercial



Healthcare

The Tintern Entrance Canopy features a simple curved roof with stainless steel tie rod fixings to create a sophisticated yet unobtrusive addition to any building.

This canopy can project up to 2.5 metres from the wall and can be constructed to an unlimited length - making it perfect for extended cover to outside areas such as retail loading bays and busy school or hospital walkways.



Features and Benefits

25 YEAR LIFE EXPECTANCY:

Our canopies have a life expectancy of up to 25 years, subject to the chosen finish.

SIZE: To your specification.

Length: 1.4m - unlimited

Projection: 0.8m – 2.5m

FRAMEWORK FINISH:

The framework is supplied in a choice of 7 colours. Alternative colours are available but may incur additional costs.

ALUMINIUM FRAME:

The frame is manufactured from T5 grade aluminium to ensure a long lasting, solid construction.

PANELS:

Covered with solid polycarbonate panels that are 4mm thick and are light in weight. These panels have a high impact resistance, making them ideal for use in well used areas. They are supplied in clear as standard.

INTEGRAL GUTTERING:

Integral aluminium guttering is included as standard which disperses water through a drip spout at the sides of the canopy frame.

LOADING CAPABILITIES:

The Tintern has passed the TÜV tests for uniformly distributed up to 170daN/m².

USES:

- > Entrance canopy
- > Walkway canopy
- > Waiting shelter



Tamworth

Entrance Canopies



Residential



Education



Hospitality
& Leisure



Retail &
Commercial



Healthcare

The Tamworth is a robust aluminium entrance canopy with a simple modern appearance. It is the most cost effective entrance canopy within our range, yet it does not compromise on quality. The frame is constructed from T5 grade aluminium which is naturally rust resistant and features high impact resistant solid polycarbonate roof panels.

Due to its minimalist design, this cantilevered entrance canopy is the ideal door shelter for new builds at schools, nurseries, shops, factories, and hospitals. It can also be a quick and low cost addition for existing builds, creating an attractive contrast to traditional styles and settings.

Features and Benefits

25 YEAR LIFE EXPECTANCY:

Our canopies have a life expectancy of up to 25 years, subject to the chosen finish.

SIZE: To your specification.

Length: 1.4m – 2m
Projection: 0.8m – 1.2m

FRAMEWORK FINISH:

The framework is supplied in a choice of 7 colours. Alternative colours are available but may incur additional costs.

ALUMINIUM FRAME:

The frame is manufactured from T5 grade aluminium to ensure a long lasting, solid construction.

PANELS:

Covered with solid polycarbonate panels that are 4mm thick and are light in weight. These panels have a high impact resistance, making them ideal for use in well used areas. They are supplied in clear as standard.

INTEGRAL GUTTERING:

Integral aluminium guttering is included as standard which disperses water through a drip spout at the sides of the canopy frame.

LOADING CAPABILITIES:

The Tamworth has passed the TÜV tests for uniformly distributed up to 170daN/m².

USES:

- > Entrance canopy
- > Walkway canopy
- > Waiting shelter





Balmoral

Entrance Canopies



Residential



Education



Hospitality
& Leisure



Retail &
Commercial

The Balmoral is a stunning, low-cost entrance canopy that features attractive ornamental brackets. It is constructed from a fully aluminium frame with hidden guttering and is protected with high impact resistant polycarbonate roof sheets.

Because the Balmoral Entrance Canopy displays exquisite, ornate detailing, it is the ideal entrance shelter for historic and well established buildings. It can provide effective protection from the weather for many organisations including schools, shops, cafés and restaurants, enhancing the appearance of their main entrance.

Features and Benefits

25 YEAR LIFE EXPECTANCY:

Our canopies have a life expectancy of up to 25 years, subject to the chosen finish.

SIZE: To your specification.

Length: 1.4m – unlimited
Projection: 1.1m – 1.5m

FRAMEWORK FINISH:

The framework is supplied in a choice of 7 colours. Alternative colours are available but may incur additional costs.

ALUMINIUM FRAME:

The frame is manufactured from T5 grade aluminium to ensure a long lasting, solid construction.

PANELS:

Covered with solid polycarbonate panels that are 4mm thick and are light in weight. These panels have a high impact resistance, making them ideal for use in well used areas. They are supplied in clear as standard.

INTEGRAL GUTTERING:

Integral aluminium guttering is included as standard which disperses water through a drip spout at the sides of the canopy frame.

LOADING CAPABILITIES:

The Balmoral has passed the TÜV tests for uniformly distributed up to 170daN/m².

USES:

- > Entrance canopy
- > Walkway canopy
- > Waiting shelter





Lexden

Entrance Canopies



Residential



Education



Hospitality
& Leisure



Retail &
Commercial



Healthcare

The Lexden Entrance Canopy has a stylish, minimalist appearance that fits in well with many building styles and makes entrances stand out prominently. It has a strong aluminium construction that is covered with high strength polycarbonate roof sheets.

Due to its square, edgy design, the Lexden Entrance Canopy provides stylish shelter for new builds and contemporary building designs and is particularly popular with offices and commercial settings, including retail and leisure organisations. Its mono-pitch design provides excellent protection from the weather and, if installed above a window or doors, it can also help to keep a buildings interior cool on hotter days.

Features and Benefits

25 YEAR LIFE EXPECTANCY:

Our canopies have a life expectancy of up to 25 years, subject to the chosen finish.

SIZE: To your specification.

Length: 1.4m – unlimited

Projection: 0.6m – 1.3m

FRAMEWORK FINISH:

The framework is supplied in a choice of 7 colours. Alternative colours are available but may incur additional costs.

ALUMINIUM FRAME:

The frame is manufactured from T5 grade aluminium to ensure a long lasting, solid construction.

PANELS:

Covered with solid polycarbonate panels that are 4mm thick and are light in weight. These panels have a high impact resistance, making them ideal for use in well used areas. They are supplied in clear as standard.

INTEGRAL GUTTERING:

Integral aluminium guttering is included as standard which disperses water through a drip spout at the sides of the canopy frame.

LOADING CAPABILITIES:

The Lexden has passed the TÜV tests for uniformly distributed up to 170daN/m².

USES:

- > Entrance canopy
- > Walkway canopy
- > Waiting shelter





Fenwick

Entrance Canopies



Residential



Education



Hospitality
& Leisure



Retail &
Commercial



Healthcare

The Fenwick Entrance Canopy has an attractive curve to the roof and has been designed for buildings that have an existing overhang. It is fixed to the overhang with brackets that are extended from the canopy roof bars for a sleek, minimalistic appearance.

This canopy has an unlimited length and a projection of up to 1.5m. It is ideal for creating shade and shelter above doors, windows, walkways and loading bays. It can also offer additional protection to buildings that have existing integrated canopies which do not offer a large enough projection.

Features and Benefits

25 YEAR LIFE EXPECTANCY:

Our canopies have a life expectancy of up to 25 years, subject to the chosen finish.

SIZE: To your specification.

Length: 1.4m – unlimited

Projection: 0.6m – 1.5m

FRAMEWORK FINISH:

The framework is supplied in a choice of 7 colours. Alternative colours are available but may incur additional costs.

ALUMINIUM FRAME:

The frame is manufactured from T5 grade aluminium to ensure a long lasting, solid construction.

PANELS:

Covered with solid polycarbonate panels that are 4mm thick and are light in weight. These panels have a high impact resistance, making them ideal for use in well used areas. They are supplied in clear as standard.

INTEGRAL GUTTERING:

Integral aluminium guttering is included as standard which disperses water through a drip spout at the sides of the canopy frame.

LOADING CAPABILITIES:

The Fenwick has passed the TÜV tests for uniformly distributed up to 170daN/m².

USES:

- › Entrance canopy
- › Walkway canopy
- › Waiting shelter





Nelson

Entrance Canopies



Residential



Education



Hospitality
& Leisure



Retail &
Commercial



Healthcare

The Nelson Entrance Canopy has a stylish domed frame that is constructed from aluminium and is covered with curved polycarbonate that is 4mm thick. It has been designed to fit in with many building styles, adding a contemporary feel to traditional buildings and fitting in seamlessly with modern buildings.

The Nelson is the perfect entrance structure for many environments including schools, shops, hospitals, healthcare surgeries, care homes and leisure environments. It can be installed above doors and windows to extend your existing building overhang and offer additional protection from the weather.

Features and Benefits

25 YEAR LIFE EXPECTANCY:

Our canopies have a life expectancy of up to 25 years, subject to the chosen finish.

SIZE: To your specification.

Length: 1.4m – 2.4m

Projection: 0.8m – 1.5m

FRAMEWORK FINISH:

The framework is supplied in a choice of 7 colours. Alternative colours are available but may incur additional costs.

ALUMINIUM FRAME:

The frame is manufactured from T5 grade aluminium to ensure a long lasting, solid construction.

PANELS:

Covered with solid polycarbonate panels that are 4mm thick and are light in weight. These panels have a high impact resistance, making them ideal for use in well used areas. They are supplied in clear as standard.

INTEGRAL GUTTERING:

Integral aluminium guttering is included as standard which disperses water through a drip spout at the sides of the canopy frame.

LOADING CAPABILITIES:

The Nelson has passed the TÜV tests for uniformly distributed up to 170daN/m².

USES:

› Entrance canopy



Tenby

Entrance Canopies



Residential



Education



Hospitality
& Leisure



Retail &
Commercial



Healthcare

The Tenby Entrance Canopy is a strong and robust aluminium and polycarbonate wall mounted structure that provides shade and shelter from all weather conditions.

The modest size and the lack of front posts makes this canopy perfect for areas that have limited space; the brackets are also smaller than our comparable structures which means that less installation room is required for fixings.

It is ideal for creating shade and shelter above your entrance doors, keeping visitors and your entrance area dry. It not only features a highly modern, mono-pitched roof with perforated brackets, but it can also be manufactured to fit around internal and external corners, allowing you to follow the shape of your building.

Features and Benefits

25 YEAR LIFE EXPECTANCY:

Our canopies have a life expectancy of up to 25 years, subject to the chosen finish.

SIZE: To your specification.

Length: Unlimited
Projection: From 0.6m – 1.3m

FRAMEWORK FINISH:

The framework can be finished in any RAL or BS colour, excluding pearl and signal colours.

ALUMINIUM FRAME:

The main frame is made from aluminium and is supplied powder coated in a choice of 7 colours. Alternative colours are available at an additional cost.

PANELS:

The frame is covered with 4mm solid polycarbonate panels that are extremely strong and is supplied in clear as standard, other tints and textures are available at an additional cost.

INTEGRAL GUTTERING:

Guttering is integrated within the canopy frame as standard with drip spouts at the sides to disperse the water.

GUARANTEE:

The steel frame is supplied with a 2 year guarantee.

USES:

- > Entrance canopy
- > Waiting shelter
- > Smoking shelter



Colwyn

Entrance Canopies



Residential



Education



Hospitality
& Leisure



Retail &
Commercial



Healthcare

The Colwyn has a simple domed design to complement modern building styles. Its clean lines give any entrance a clean, fresh look whilst providing cover and highlighting the correct entrance for customers to use.

Its cantilevered design means there are no posts to bump into – making it a perfect choice for schools, shops, leisure and healthcare organisations.



Features and Benefits

25 YEAR LIFE EXPECTANCY:

Our canopies have a life expectancy of up to 25 years, subject to the chosen finish.

SIZE: To your specification.

Length: 1.4m – 2.4m

Projection: 0.8m – 2m

FRAMEWORK FINISH:

The framework is supplied in a choice of 7 colours. Alternative colours are available but may incur additional costs.

ALUMINIUM FRAME:

The frame is manufactured from T5 grade aluminium to ensure a long lasting, solid construction.

PANELS:

Covered with solid polycarbonate panels that are 4mm thick and are light in weight. These panels have a high impact resistance, making them ideal for use in well used areas. They are supplied in clear as standard.

INTEGRAL GUTTERING:

Integral aluminium guttering is included as standard which disperses water through a drip spout at the sides of the canopy frame.

LOADING CAPABILITIES:

The Colwyn has passed the TÜV tests for uniformly distributed up to 170daN/m².

USES:

› Entrance canopy

05

Our range of Bioclimatic Pergolas features a selection of wall mounted and free standing canopies that are stunning, high-end shade and shelter structures.

There is a total of two products within the range which consist of superior aluminium frames with adjustable aluminium roof slats that can be opened and closed as required.

Bioclimatic Pergolas

Imperial Senior
Imperial Grand



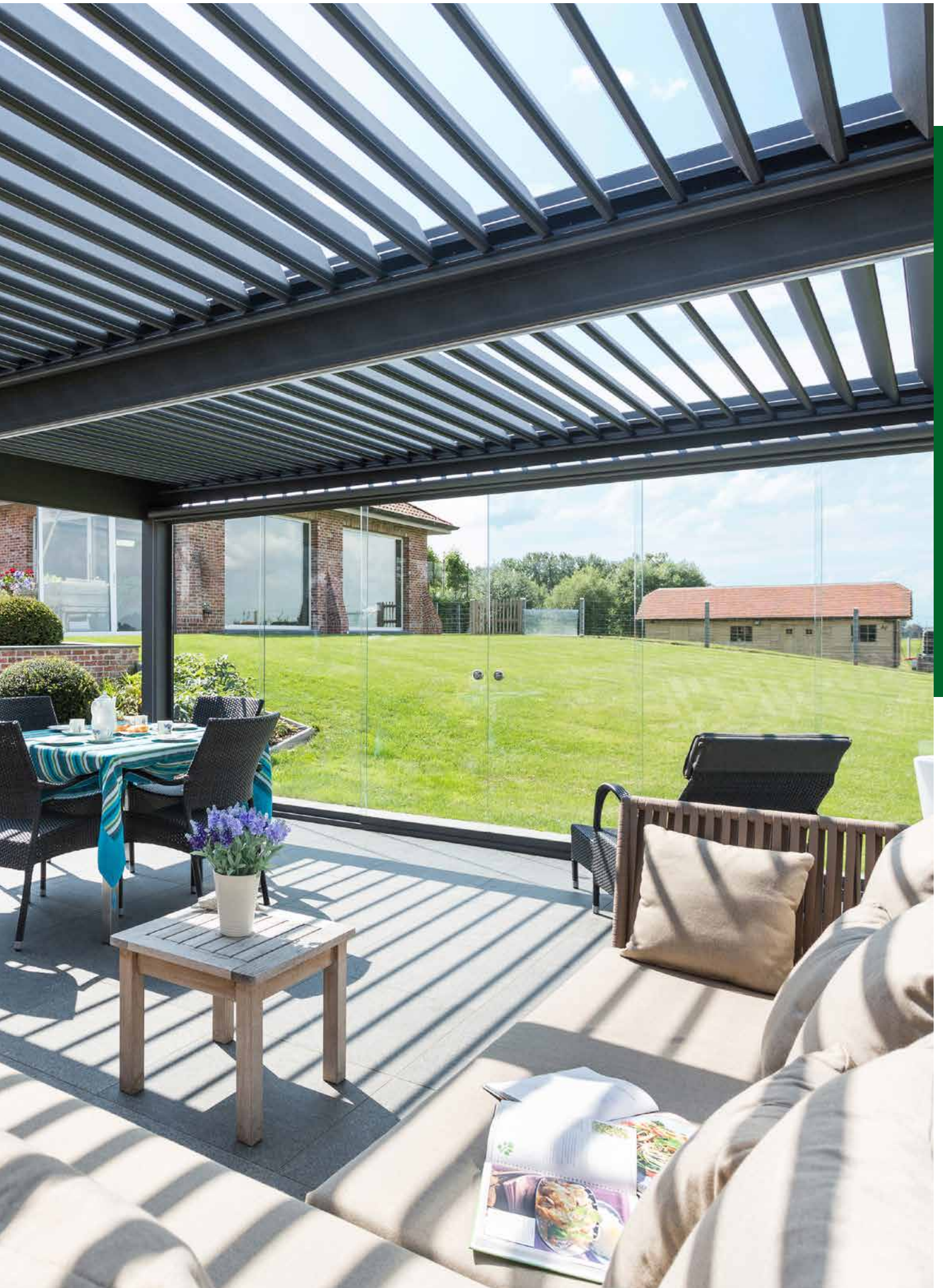



Imperial Senior

Bioclimatic Pergolas



Residential



Education



Hospitality
& Leisure



Retail &
Commercial



Healthcare

The Imperial Senior is a highly attractive canopy that is available as a free standing or wall mounted structure. It features electronic roof slats that can be adjusted with the Somfy motor and remote control supplied.

You can block 100% of the sun's harmful UV rays when the roof slats are closed as well as creating a watertight seal and protection from rainfall. Alternatively, on a hot summers day, you can choose to have the roof slats open at the angle of your choice to allow a cool breeze to flow through as well as provide partial shade.

Features and Benefits

10 YEAR GUARANTEE:

The Imperial Senior is supplied with a 10 year guarantee for the frame and roof slats and 3 years for the mechanisms.

SIZE: To your specification.

Length: Up to 7 metres

Width: Up to 7 metres

Multiple structures can be connected to cover much larger areas.

ALUMINIUM FRAME & ROOF:

The canopy frame and roof slats are made from high grade aluminium for the ultimate strength and longevity.

FRAMEWORK FINISH:

The frame and roof slats are supplied in a choice of 7 standard colours however, other RAL colours are available at an additional cost.

100% UV PROTECTION:

When the roof slats are completely closed, they offer 100% UV protection.

INTEGRATED GUTTERING:

Integrated guttering is supplied as standard within the roof profiles and water is dispersed through the bottom of the canopy posts. This creates a smooth, clean line appearance.

OPTIONAL EXTRAS:

- > Heaters
 - > LED Lighting
 - > Fabric Side Panels
 - > Sliding Glass Panels
 - > Adjustable Side Panels
- See pages 86-87*

USES:

- > Spa canopy
- > Leisure canopy
- > Courtyard shelter
- > Relaxation Shelter
- > Alfresco dining canopy within restaurants and bars
- > Hotel canopy



Imperial Grand

Bioclimatic Pergolas



Residential



Education



Hospitality
& Leisure



Retail &
Commercial



Healthcare

The Imperial Grand is a striking aluminium canopy that can be supplied as a wall mounted or free standing structure. As with both canopies in our Bioclimatic Pergola Range, the Imperial Grand features adjustable roof slats and has the added benefit of hidden fixings and hidden electrical wires.

The adjustable roof slats allow you to provide the perfect weather protection to suit the current climate. When they are completely closed, your customers will benefit from 100% protection from UV rays as well as a water tight seal for shelter from the rain. When they are open at the angle of your choice, you can offer partial shade and allow a cooling breeze to flow through.

The Imperial Grand features hidden fixings and wires within the canopy frame.

Features and Benefits

10 YEAR GUARANTEE:

The Imperial Senior is supplied with a 10 year guarantee for the frame and roof slats and 3 years for the mechanisms.

SIZE: To your specification.

Length: Up to 7 metres

Width: Up to 7 metres

Multiple structures can be connected to cover much larger areas.

ALUMINIUM FRAME & ROOF:

The canopy frame and roof slats are made from high grade aluminium for ultimate strength and longevity.

FRAMEWORK FINISH:

The frame and roof slats are supplied in a choice of 7 standard colours however, other RAL colours are available at an additional cost.

100% UV PROTECTION:

When the roof slats are completely closed, they offer 100% UV protection.

INTEGRATED GUTTERING:

Integrated guttering is supplied as standard within the roof profiles and water is dispersed through the bottom of the canopy posts. This creates a smooth, clean line appearance.

OPTIONAL EXTRAS:

- > Heaters
 - > LED Lighting
 - > Fabric Side Panels
 - > Sliding Glass Panels
 - > Adjustable Side Panels
- See [pages 86-87](#)

USES:

- > Spa canopy
- > Leisure canopy
- > Courtyard shelter
- > Relaxation Shelter
- > Alfresco dining canopy within restaurants and bars
- > Hotel canopy



Optional Extras

Bioclimatic Pergolas



Heaters



Heaters

Heaters

Warm up your guests and encourage use of your outside area on colder days or evenings by incorporating heaters into your bioclimatic pergola. The heaters are fully waterproof, making them perfect for outdoor use all year round.



LED Lighting



LED Lighting

LED Lighting

Gain as much use as possible from your canopy by adding LED lighting to enable your customers and visitors to stay outside long into the night, perfect for those late summer evenings. Choose from strip lights or spot lights, both of which are LED.



Adjustable Side Panels

Sliding panels allow you to create a screen between the outside and the inside of your canopy whilst still offering visibility and a cool breeze to flow through. Made from aluminium to match the adjustable roof panels, they blend in with the canopy seamlessly.



Adjustable Side Panels

Optional Extras

Bioclimatic Pergolas

Fabric Side Panels

Create a private experience which is perfect for alfresco dining and outdoor exercise classes with our fabric side panels which are available in a choice of fabrics and colours to fit in with your outside area perfectly.

They are electronically controlled with the Somfy motor and remote control supplied.



Fabric Side Panels



Fabric Side Panels

Sliding Glass Panels

You can transform your Bioclimatic Pergola into an enclosed glass room by adding sliding glass panels that slide open and shut on smooth guides. This leaves you with the option to open them when the weather is pleasant or to close them when the weather is not so pleasant.



Sliding Glass Panels



Sliding Glass Panels

06

Generate free electricity and earn an additional income with a solar canopy. Solar canopies enable you to provide shade from the sun and shelter from the rain whilst collecting clean energy for your school or business. They are perfect for organisations that are unable to have solar panels installed on their roof due to the direction that the building is facing, or if shading is a problem. We can position our canopies to ensure that you get the best from your solar panels.

Integrated Solar Canopies

The Albedo Effect
Grange Mono-Pitch
Grange Apex
Kensington Mono-Pitch
Kensington Dual-Pitch



Able Solar Canopies

Generate free electricity and earn an additional income* with a solar canopy. Solar canopies enable you to provide shade from the sun and shelter from the rain whilst collecting clean energy for your school or business. They are perfect for organisations that are unable to have solar panels installed on their roof due to the direction that the building is facing, or if shading is a problem. We can position our canopies to ensure that you get the best from your solar panels.

There are five designs of solar canopies within our range for you to choose from, all of which are robust free standing structures constructed from steel or aluminium frames and covered with high quality solar panels. The solar panels are integrated into the canopy itself using a glass panel design which is like nothing else on the market.

Our solar canopies are energy efficient structures that have a triple purpose of providing shade and shelter whilst also generating free electricity for your organisation; they are perfect for reducing your carbon footprint and saving costs on electricity bills. These canopies will also pay for themselves over the years through the electricity they generate.

Our solar canopies can be used for covered waiting areas and walkways, playgrounds, trolley shelters, car parks, alfresco dining and much more. They are also brilliant for outdoor learning areas, offering the perfect opportunity to teach pupils about how solar energy is generated and how it can help to save the environment.

*An additional income can be generated by signing up to the Smart Export Guarantee (SEG) which is available from 1st January 2020.



Energy Security

In a changing world, energy security is becoming an important issue. Fitting a solar canopy will not only pay for the canopy over time but will also contribute to:

- › Significantly reducing overheads
- › Protect against rising energy prices with fixed unit cost
- › Reduce on-site energy usage and reliance on the grid
- › Reduce your carbon footprint, increase sustainability credentials and enhance your reputation.

Colours

We offer a vast range of colours which can be chosen to blend in or contrast with any existing environment and colour scheme.

For those canopies constructed using steel, the posts can be galvanised, powder coated to any standard RAL colour or galvanised/powder coated. Other non-standard RAL colours are available at an additional cost.

The aluminium frame is supplied powder coated to any standard RAL colour, non-standard RAL colours are available at an additional cost.



Bespoke Solar Canopy installed at Capel Manor Primary School in Enfield, Middlesex



The Albedo Effect

Solar Canopies



Residential



Education



Hospitality
& Leisure



Retail &
Commercial



Healthcare

The Albedo Effect Solar Canopy is a stunningly modern free standing canopy structure and its unique design will be a talking point in any setting. With a projection of up to 5 metres and unlimited length it can easily cover large areas and generates even more energy by utilising the light that is reflected back from the ground surface.

It is covered with superior solar panels that convert sunlight into solar energy. The posts are constructed from strong steel box sections that can be galvanised and powder coated in the standard RAL colour of your choice. The roof frame and integrated guttering and downpipes are manufactured from aluminium which is naturally non-corrosive and can also be powder coated to any standard RAL colour.

Features and Benefits

25 YEAR LIFE EXPECTANCY:

Life expectancy of up to 25 years, subject to the chosen finish.

SIZE: To your specification.

Length: Unlimited
Width: Up to 5 metres
Height: to your specification

ROOF FRAME:

Fully aluminium roof frame, including aluminium roof bars, coloured in white as standard, other colours available on request.

STEEL UNDERSIDE FRAME AND POSTS:

120mm x 70mm steel box section. The steel framework can be galvanised and/or powder coated to any standard RAL colour.

FRAMEWORK FINISH:

The roof frame is finished in white as standard, other colours are available at an additional cost. The steel posts are available in any standard RAL colour, non-standard RAL colours may incur additional costs.

PANELS:

The Albedo is covered with the highest quality solar panels that soak up the sun's energy from both sides of the panels, ensuring maximum solar absorption.

GUTTERING:

Integral aluminium guttering with uPVC downpipes.

OPTIONAL EXTRAS:

- > Benches and picnic tables
- > Cycle racks

USES:

- > Covered outdoor dining area
- > Playground canopy
- > Cycle shelter





Grange Mono-Pitch

Solar Canopies



Residential



Education



Hospitality
& Leisure



Retail &
Commercial



Healthcare

Create attractive shade and shelter in your outside area whilst generating free energy and earning an added revenue from any leftover energy you don't use.

The Grange Mono-Pitch Solar Canopy has a simple yet effective design that allows you to create the shade and shelter required for your pupils, customers or visitors whilst your school or company benefit from the Smart Export Guarantee (SEG) from Jan 2020.

The design of the Grange Mono-Pitch Solar Canopy works perfectly against any building, making it look like a wall mounted canopy – ideal for those that do not have a building that is suitable for use as a support.

The canopy is constructed from a strong steel frame, integrated with the highest quality glass solar panels.

Features and Benefits

25 YEAR LIFE EXPECTANCY:

Life expectancy of up to 25 years, subject to the chosen finish.

SIZE:

 Available in four sizes:

20.3m x 3.3m	(10 kWp system)
40.6m x 3.3m	(20 kWp system)
60.9m x 3.3m	(30 kWp system)
101.5m x 3.3m	(50 kWp system)

ROOF FRAME:

Fully aluminium roof frame, including aluminium roof bars, coloured in white as standard, other colours available on request.

STEEL UNDERSIDE FRAME AND POSTS:

120mm x 60mm x 3mm steel box section. The steel framework can be galvanised and/or powder coated to any standard RAL colour.

FRAMEWORK FINISH:

The roof frame is finished in Hipca White as standard, other colours are available at an additional cost. The steel posts are available in any standard RAL colour, non-standard RAL colours may incur additional costs.

PANELS:

The Grange is covered with the highest quality solar panels that soak up the sun's energy from both sides of the panels, ensuring maximum solar absorption.

GUTTERING:

Integral aluminium guttering with uPVC downpipes.

OPTIONAL EXTRAS:

- > Secure roller shutters
- > Side panels
- > Rainbow package
- > Post pads
- > Signage

See pages 48-49

USES:

- > Covered outdoor walkway
- > Playground canopy
- > Waiting area and pick up point
- > Covered outdoor dining area







Grange Apex

Solar Canopies



Residential



Education



Hospitality
& Leisure



Retail &
Commercial



Healthcare

Offer your pupils, staff or customers shade and shelter from the weather whilst generating electricity that you can use and sell – via the Smart Export Guarantee (SEG) from Jan 2020.

The Grange Apex Solar Canopy features solar panels on both sides of the apex roof, making it perfect for east/west elevations, ensuring you generate high levels of solar energy all day long.

The Grange Apex Solar Canopy can cover extra-large areas making it perfect for creating cover for outdoor sports areas at leisure centres, outdoor learning areas at schools, cover for car parks and covered walkways or picnic areas at retail centres and visitor attractions. It is also an excellent teaching aid within schools, allowing you to teach your pupils about solar energy whilst sitting under a solar canopy.

Features and Benefits

25 YEAR LIFE EXPECTANCY:

Life expectancy of up to 25 years, subject to the chosen finish.

SIZE: Available in four sizes:

10.1m x 6.6m	(10 kWp system)
20.3m x 6.6m	(20 kWp system)
30.4m x 6.6m	(30 kWp system)
50.7m x 6.6m	(50 kWp system)

ROOF FRAME:

Fully aluminium roof frame, including aluminium roof bars, coloured in white as standard, other colours available on request.

STEEL UNDERSIDE FRAME AND POSTS:

120mm x 60mm x 5mm steel box section. The steel framework can be galvanised and/or powder coated to any standard RAL colour.

FRAMEWORK FINISH:

The roof frame is finished in Hipca White as standard, other colours are available at an additional cost. The steel posts are available in any standard RAL colour, non-standard RAL colours may incur additional costs.

PANELS:

The Grange Apex is covered with the highest quality solar panels that soak up the sun's energy from both sides of the panels, ensuring maximum solar absorption.

GUTTERING:

Integral aluminium guttering with uPVC downpipes.

OPTIONAL EXTRAS:

- > Secure roller shutters
- > Side panels
- > Rainbow package
- > Post pads
- > Signage

See pages 48-49

USES:

- > Covered outdoor walkway
- > Playground canopy
- > Waiting area and pick up point
- > Covered outdoor dining area



Kensington Mono-Pitch

Solar Canopies



Residential



Education



Hospitality
& Leisure



Retail &
Commercial



Healthcare

The Kensington Mono-Pitch Solar Canopy is a stylish shade and shelter structure that looks great in any environment. The Kensington range is constructed from steel and features a substantial frame which gives it a modern, industrial look. The Kensington Mono-Pitch is a cantilevered structure that only has one set of posts, making it ideal for those that require minimal amount of supports, it also makes the design less obtrusive to your outside area.

The Kensington Mono-Pitch Solar Canopy offers effective protection from rain, sun and snow. The Canopy is constructed from a strong steel frame that has a life expectancy of up to 25 years depending on the chosen finish and is covered with high quality solar panels.

Features and Benefits

25 YEAR LIFE EXPECTANCY:

Life expectancy of up to 25 years, subject to the chosen finish.

SIZE: Available in four sizes:

20.3m x 3.3m	(10 kWp system)
40.6m x 3.3m	(20 kWp system)
60.9m x 3.3m	(30 kWp system)
101.5m x 3.3m	(50 kWp system)

STEEL UNDERSIDE FRAME AND POSTS:

Main frame: 200mm x 200mm x 6mm steel box section.

FRAMEWORK FINISH:

The steel framework can be galvanised and/or powder coated to any standard RAL colour.

PANELS:

Covered with the highest quality solar panels that soak up the sun's energy from both sides of the panels, ensuring maximum solar absorption.

GUTTERING:

Fitted with guttering and uPVC downpipes as standard.

OPTIONAL EXTRAS:

- > Post pads
- See pages 48-49

USES:

- > Entrance canopy
- > Covered walkway
- > Airport shelter/link way

The Kensington Mono-Pitch Solar Canopy offers effective protection from rain, sun and snow. The Canopy is constructed from a strong steel frame that has a life expectancy of up to 25 years depending on the chosen finish.







The Kensington Dual-Pitch is the perfect solar canopy for many businesses including visitor attractions, leisure resorts, sports clubs and hotels as well as schools and colleges.

Kensington Dual-Pitch

Solar Canopies



Residential



Education



Hospitality
& Leisure



Retail &
Commercial



Healthcare

The Kensington Dual-Pitch Solar Canopy is a stylish shade and shelter structure that looks great in any environment. The Kensington range is constructed from steel and features large posts which gives it a modern, industrial look. The Kensington Dual-Pitch is a cantilevered structure that only has one set of posts, making it ideal for those that require minimal amount of posts, it also makes the design less obtrusive to your outside area.

The canopy offers effective protection from rain, sun and snow. It is constructed from a strong steel frame that has a life expectancy of up to 25 years depending on the chosen finish.

Features and Benefits

25 YEAR LIFE EXPECTANCY:

Life expectancy of up to 25 years, subject to the chosen finish.

SIZE: Available in four sizes:

10.1m x 6.6m	(10 kWp system)
20.3m x 6.6m	(20 kWp system)
30.4m x 6.6m	(30 kWp system)
50.7m x 6.6m	(50 kWp system)

STEEL UNDERSIDE FRAME AND POSTS:

Main frame: 200mm x 200mm x 6mm steel box section.

FRAMEWORK FINISH:

The steel framework can be galvanised and/or powder coated to any standard RAL colour.

PANELS:

The Kensington Dual-Pitch is covered with the highest quality solar panels that soak up the sun's energy from both sides of the panels, ensuring maximum solar absorption.

GUTTERING:

Fitted with guttering and uPVC downpipes as standard.

OPTIONAL EXTRAS:

- > Post pads
- See [pages 48-49](#)
- > Picnic tables and benches

USES:

- > Entrance canopy
- > Covered walkway
- > Covered outdoor dining area
- > Airport shelter/link way

07

In addition to our comprehensive range of standard canopy and shelter designs, we can also create structures designed to your specific requirements, allowing you to bring an idea to reality and create a truly unique structure.

Bespoke Canopies

Design & Build
Glass Canopies







Design & Build

Bespoke Canopies



Residential



Education



Hospitality
& Leisure



Retail &
Commercial



Healthcare

At Able Canopies, we have a dedicated Design & Build team who have extensive expertise in creating unique canopies to meet our customers' individual needs.

With exceptional CAD capabilities and a flair for design, our Design & Build engineers ensure we are light years ahead of our competitors with our ability to create real, practical, and cost effective solutions combined with eye catching and original designs.

We regularly work alongside architects, designers and specifiers to create structures to fit the requirements of specific projects.

Our design engineers can work from hand sketches or CAD drawings to create technical drawings in a range of formats, plus 3D renders of the structure in situ to allow you to gain an understanding of the impact the structure will have to the aesthetics of its surroundings.

Whether money is no object or your budget is very tight, our design team can work alongside you to create a structure that fits with your budget and project deadlines. So if you have a unique canopy structure in mind, please do not hesitate to contact us to find out how we can turn your vision into reality.





Glass Canopies

Bespoke Canopies



Residential



Education



Hospitality
& Leisure



Retail &
Commercial



Healthcare



Our Design & Build team have particular expertise in creating bespoke glass structures; using cutting edge 3D CAD design, our engineers can design, manufacture and install unique glass entrance, freestanding, walkway or wall mounted canopies which have been constructed to meet your individual requirements.

Glass canopies provide excellent cover from the weather; they have a modern, sleek design, are easy to clean and extremely long lasting, which in turn will enable you to use your outside space more effectively for many years to come.

Glass canopies also have improved acoustic properties when compared with polycarbonate roofing, making them ideal for areas where ambient noise needs to be kept to a minimum.

Our glass canopies are very popular with Contractors, Schools, Councils, Architects and Specifiers and they are perfectly suited for all commercial sectors including Retail, Leisure and the Education sectors.

08

The Able Canopies Shade Sail range offers almost unlimited design and shape potential allowing you to create a stylish and effective shading system. They are ideal for a variety of applications including creating shade for play areas, parks, picnic areas, car parks and outside dining areas for restaurants, pubs or bars.

Our shade sail systems are premium products designed specifically for commercial use and are available in a wide range of fabric colours.

Able Shade Sail systems are long lasting and extremely durable structures which protect those underneath from the sun's powerful UV rays. They are designed specifically to be left outdoors 365 days a year and will not need re-tensioning.

Able Shade Sails







Able Shade Sails



Education



Hospitality
& Leisure

Able Shade Sails are versatile, practical and easily maintained. They are available in a wide range of colours and offer extremely high levels of UV protection combined with strength and durability.

Our Shade Sails offer great potential within the retail, leisure and education sectors to create visually stunning structures whilst enhancing the comfort and safety of customers and staff.

Features and Benefits

STRONG STRUCTURES:

Able Shade Sails are permanent structures supported by galvanised steel posts which are installed into a concrete base with anchor bars. The posts can be up to 4.5 metres in height (above ground level) and are set in concrete to a maximum depth of 2 metres. Anti-climb cones can be fitted if required to deter vandals - please see page 111.

FABRIC:

The shade sail cloth is made from 340gsm knitted polyethylene fabric which will not absorb moisture. It is lock stitched using advanced technology for more air movement and better channeling of cooling breezeways. It is also recyclable, tear resistant and will not crack, rot or fade.

- › Post structures have a life expectancy of up to 25 years
- › 10 year warranty given against UV degradation of the shade sail fabric
- › Shade sail fabric blocks up to 98.8% of UV rays

- › Rectangle, square and triangular sails are available.
- › Maximum sail size is 6 metres x 6 metres.
- › Hot dip galvanised steel posts as standard.
- › Our shade sail fabric is available in 16 contemporary colours to enhance your surroundings - see page 110.

OPTIONAL EXTRAS:

- › Anti-climb cones
 - › Post pads
 - › Fabric side panels
- See page 111*

USES:

- › Playground canopy
- › Outdoor classroom
- › Large shaded area
- › Covered outdoor dining/seating area

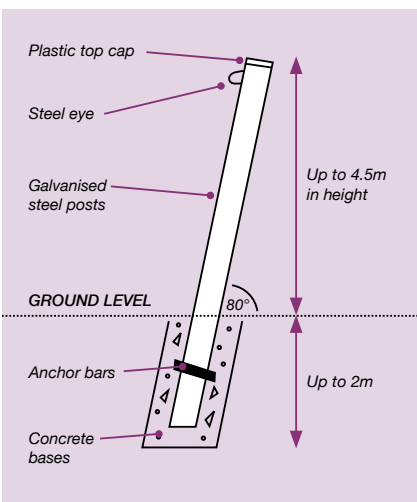



Fabric Information

Shade Sails

Shade Sail Fabric colour options

Our Shade Sail fabric is available in 15 colours to compliment your surroundings.



Shade and UVR properties chart

PHYSICAL PROPERTIES:

Weight	340gsm
Thickness	1.6mm
Construction:	Monofilament & tape
Yarn:	UV stabilised HDPE
Temperature Range	-30°C to +75°C

SHADE AND UVR PROPERTIES:

Colour	% UVR Block
Aquatic Blue	94.2%
Black	95.1%
Brunswick Green	96.9%
Gun Metal	97.7%
Cherry Red	91.0%
Deep Ochre	96.7%
Desert Sand	94.8%
Natural	95.1%
Navy Blue	98.8%
Rivergum	93.0%
Sky Blue	96.8%
Steel Grey	96.7%
Cayenne	94.0%
Turquoise	95.4%
Yellow	93.2%

Tested according to AS 4174 synthetic shade cloth.



• Fabric sample

Anti Climb Cones

Anti Climb Cones are excellent additions to your shade structure purchase and are designed to prevent vandals climbing the posts. They are available hot dipped galvanised or powder coated to any standard RAL colour of your choice.



Optional Extras

Shade Sails

Post Pads

Our post pads are a popular choice for schools and nurseries as they provide protection from everyday knocks and bumps. They can be fitted to all our Shade Sails and contain the finest non moisture-absorbent foam to offer superb protection. They also feature fixing straps and drain holes to maximise the life of the post pads.

- > Protect your children as they run and play
- > Easy to fit, they just wrap around the post using industrial Velcro
- > Filled with high impact absorbing foam for safety
- > Can be removed easily for cleaning
- > Reinforced PVC outers
- > Breathable waterproof lining
- > 1 year guarantee.

Colour options



Fabric Side Panels

Fabric side panels are available on all our shade sails structures. These side panels help to shelter occupants from the wind and create a more enclosed canopy.

09

Our range of high quality waterproof tensile fabric structures are perfect for use as outdoor classrooms, play areas, walkways, alfresco dining areas and creating covered car parking.

Able Canopies are committed to providing you with the perfect outdoor cover solution. We have ten tensile structures to choose from along with a bespoke Design & Build service. All structures are designed to independent engineer's specifications.

Tensile Fabric Structures

Codale Conic

Codale Junior

Ulverston Umbrella

Blenheim Umbrella

Dallington Umbrella

Keswick Umbrella

Windsor

Evershade

Drayton Umbrella

Richmond Umbrella

Kendal

Fabric Options

Upgrade Options

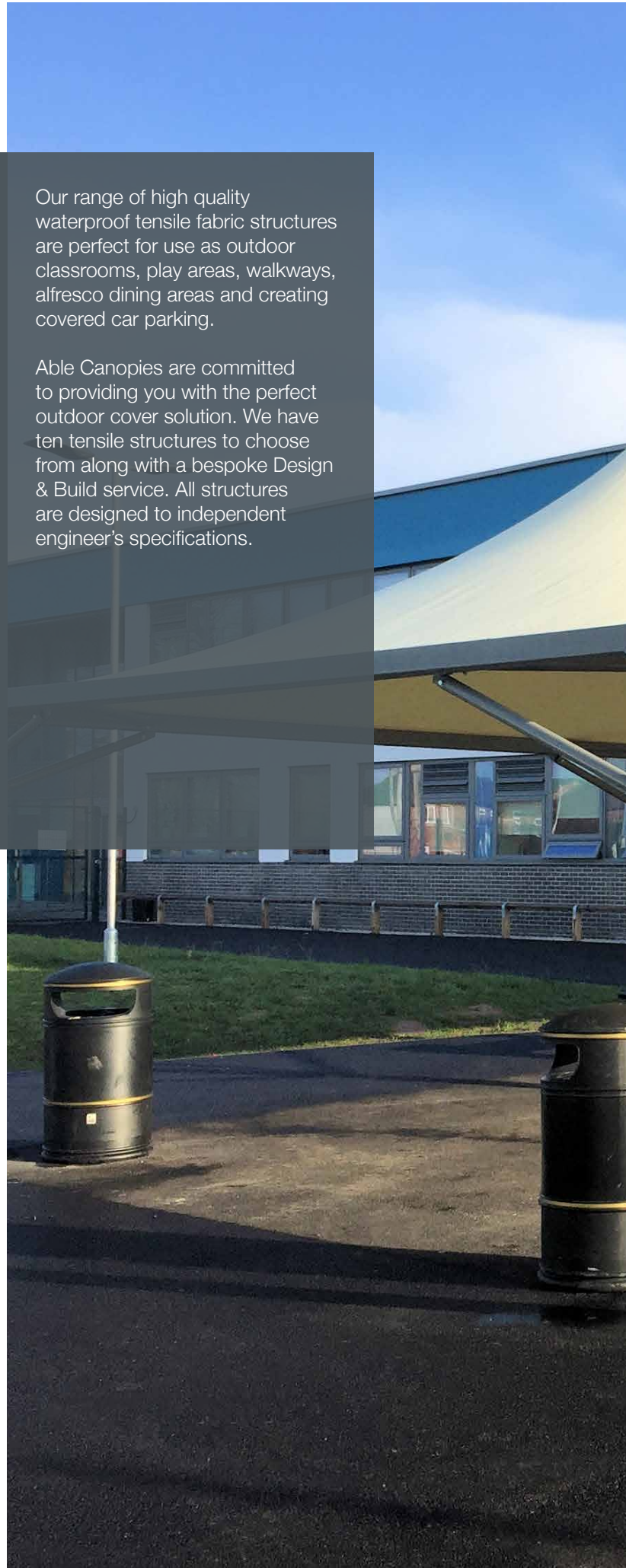



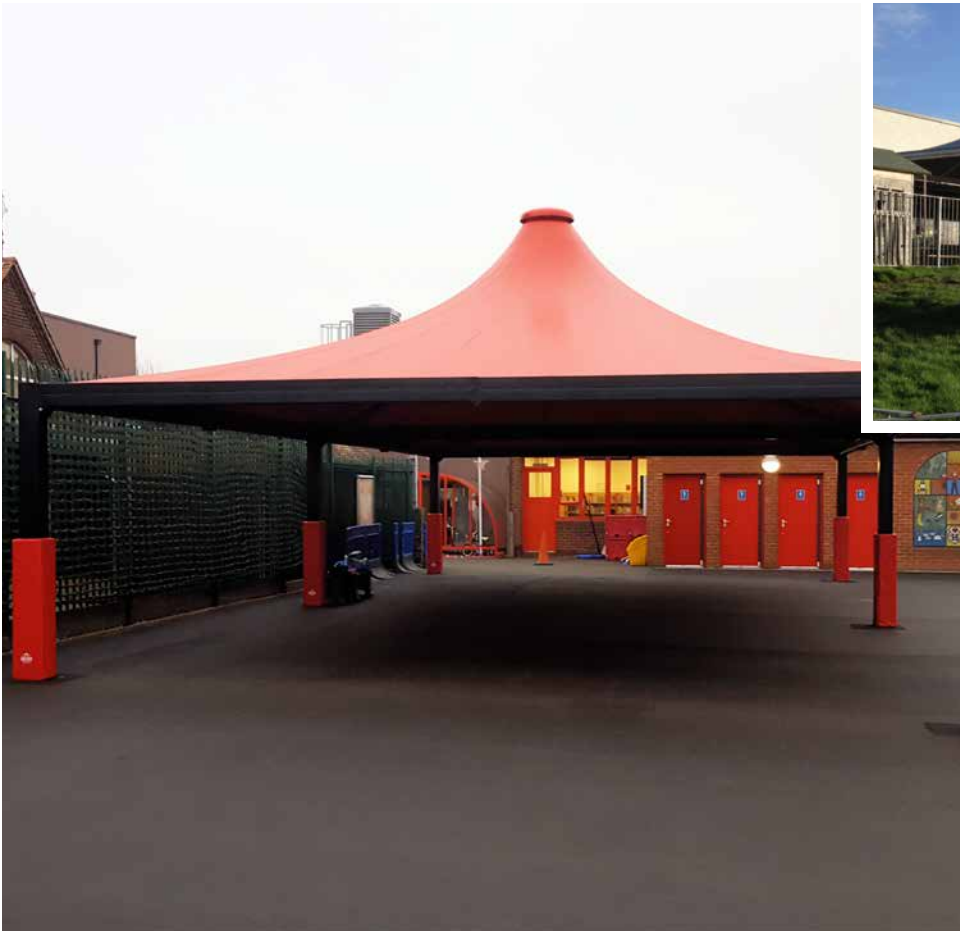

Codale Conic

Tensile Fabric Structures



Residential



Education



Hospitality
& Leisure



Retail &
Commercial



Healthcare

The Codale's elegant design, with its striking curves up to the centre, offers stylish and effective cover from the weather.

The tensile structure can span up to 15 metres in length and 15 metres wide, and due to its modular design, multiple Codales can easily be installed together to create a larger canopy which can be used to create a walkway or large shaded area.

Features and Benefits

25 YEAR LIFE EXPECTANCY:

The canopy frame is galvanised and powder coated in a choice of 25 matt colours as standard.

SIZE:

Minimum size: 3m length x 3m width
Maximum size: 15m length x 15m width

FABRIC:

Waterproof tensile fabric available in 16 contemporary colours - please contact us for more details.

FRAMEWORK:

For structures up to 7m x 7m: The Main Frame is made from 150mm x 100mm steel box sections.

For structures up to 15m x 15m: The Main Frame is made from 200mm x 150mm steel box sections.

UV PROTECTION:

Fabric roof offers complete UV protection.

FABRIC GUARANTEE:

The Fabric has a 6 year guarantee and a life expectancy of 15 years. The steel frame has a 10 year guarantee, both are subject to terms and conditions.

GUTTERING:

Integral deep flow guttering - rain water drains down through the leg columns, exiting at a drainage hole at the bottom.

OPTIONAL EXTRAS:

- > Tensile side panels
- > Post pads
- See page 125
- > Secure roller shutters
- > Heating and lighting fixtures
- > PVCu walls and glazing
- > Terrace screens
- > Lux roof skylight

USES:

- > Play canopy
- > Covered outdoor dining area
- > Outdoor classroom



Codale Junior

Tensile Fabric Structures



Residential



Education



Hospitality
& Leisure



Retail &
Commercial



Healthcare

The Codale Junior is a cost effective version of the Codale Conic that is suited to those that have smaller budgets and would like to cover areas up to 25m².

This steel structure has a waterproof tensile fabric roof that offers high levels of UV protection from the sun and also shelters those underneath from the rain, wind and snow, making it perfect for creating all-year-round outdoor cover.

The frame is supplied galvanised and matt powder coated in a choice of 25 RAL colours and the fabric is also available in a choice of 16 different shades.

Features and Benefits

25 YEAR LIFE EXPECTANCY:

The canopy frame is galvanised and powder coated in a choice of 25 matt colours as standard.

SIZE:

Available from 3m x 3m to 5m x 5m and can be rectangular or square

FABRIC:

Waterproof tensile fabric available in 16 contemporary colours - please contact us for more details.

FRAMEWORK:

Made from 80mm x 80mm steel box sections that are galvanised as standard.

UV PROTECTION:

The fabric is waterproof 650g/sm PVC that is lacquered on both sides for a high gloss appearance and also offers high UV protection from the sun.

FABRIC GUARANTEE:

The Fabric has a 6 year guarantee and a life expectancy of 15 years. The steel frame has a 10 year guarantee, both are subject to terms and conditions.

GUTTERING:

Supplied with integral guttering for ease of maintenance and sleek appearance.

OPTIONAL EXTRAS:

- > Heating
- > Lighting
- > PVCu fabric walls
- > Terrace screens
- > Seating

USES:

- > Outdoor classrooms
- > Playground canopies
- > AI fresco dining shelters



Ulverston Umbrella

Tensile Fabric Structures



Residential



Education



Hospitality
& Leisure



Retail &
Commercial



Healthcare

The Ulverston is a striking tensile umbrella structure which is supported by a robust tubular steel post. This design creates an attractive shade and shelter structure which is perfectly suited to outdoor seating and dining areas and looks stunning in both natural and urban landscapes.

This umbrella can be constructed to cover an area of up to 6 metres square, and creates an attractive effect when multiple umbrellas are installed next to each other.

Features and Benefits

25 YEAR LIFE EXPECTANCY:

The fabric comes with a 5-year guarantee and a life expectancy of 10 - 15 years. The framework has a life expectancy of up to 25 years, depending on the chosen finish.

SIZE:

Available sizes are 3, 4, 5, and 6 metres square.

FABRIC:

100% waterproof tensile roof which also offers high UV protection.

FRAMEWORK:

The umbrella frame can be powder coated to any RAL colour of your choice to allow you to match it to the surrounding environment.

The frame can also be galvanised for ultimate corrosion protection.

FABRIC:

Tensile fabric available in 40 vibrant colours including metallic finishes, see page 84 for more details.

OPTIONAL EXTRAS:

- > Post pads
- See *page 125*

USES:

- > Covered outdoor dining area
- > Outdoor classroom
- > Courtyard cover
- > Waiting canopy
- > Shaded storytelling area



Blenheim Umbrella

Tensile Fabric Structures



Residential



Education



Hospitality
& Leisure



Retail &
Commercial



Healthcare

The Blenheim is a strong waterproof umbrella structure that can be closed when not in use. This product is perfect for everyday use within restaurants, pubs & cafés for alfresco dining; parks, schools and leisure centres for shade and shelter; and hospitals and care homes for relaxing sheltered outside areas.

As an added extra, the Blenheim rarely requires structural calculations or building regulations as it is a collapsible structure, making the installation process simple and fast.

Features and Benefits

15 YEAR LIFE EXPECTANCY:

10 year fabric guarantee against UV degradation. Structure has a life expectancy of 10 - 15 years.

SIZE:

Available Sizes: 2.8m x 2.8m and 4.2m x 4.2m

Multiple umbrellas can be linked together to create a larger covered area.

COLLAPSIBLE:

Can be opened and closed as and when required with simple pulley system.

MAINTENANCE:

Simple to maintain and keep clean.

FABRIC:

100% waterproof tensile fabric which offers high UV protection, available in 40 vibrant colours including metallic finishes, see page 146 for more details.

FRAMEWORK:

Framework is constructed from a 76mm tubular post which has been precision engineered with either 304 or 316 grade stainless steel.

BRANDING:

Easily add branding/advertising to your umbrella fabric.

OPTIONAL EXTRAS:

- > Post Pads
- > Fabric side fills
- See page 125
- > Screen printing/Vinyl branding options
- > Lighting
- > Heating
- > "Fast Bar" (Integrated table)

USES:

- > Alfresco dining
- > Pub garden canopy
- > Playground shelter
- > Collapsible umbrella



Dallington Umbrella

Tensile Fabric Structures



Residential



Education



Hospitality & Leisure



Retail & Commercial



Healthcare

The Dallington Umbrella is a beautifully styled permanent umbrella structure which is supported by a tubular steel post and is covered with the highest grade waterproof tensile fabric. This structure is similar to the Ulverston Umbrella, yet has an elegant square roof design making it a stunning addition to any environment.

The Dallington is the perfect shade and shelter solution for universities, colleges, pubs and restaurants.

Features and Benefits

25 YEAR LIFE EXPECTANCY:

The fabric comes with a 5-year guarantee and a life expectancy of 10 - 15 years. The framework has a life expectancy of up to 25 years, depending on the chosen finish.

SIZE:

Can span up to 6 metres x 6 metres.

ROOF:

Square edged roof to allow umbrellas to be installed adjacent to each other.

FABRIC:

The tensile fabric has an unmatched strength with a weight of 590gsm and is available in 40 vibrant colours including metallic finishes, see page 125 for more details. It is 100% waterproof.

FRAMEWORK:

The canopy frame can be galvanised for ultimate corrosion protection and/or powder coated to any RAL colour of your choice.

UV PROTECTION:

High UV protection

OPTIONAL EXTRAS:

> Post pads
See page 125

USES:

- > Play canopy
- > Covered outdoor dining area
- > Sheltered seating area
- > Outdoor classroom
- > Medium freestanding canopy



Keswick Umbrella

Tensile Fabric Structures



Residential



Education



Hospitality
& Leisure



Retail &
Commercial



Healthcare

The Keswick is an attractive cantilever umbrella structure which is ideal for small or large outdoor spaces especially in outdoor learning and play environments.

This structure is covered with our exclusive waterproof tensile fabric and due to its design, offers a spacious area underneath the structure which is free from a central post.

Features and Benefits

25 YEAR LIFE EXPECTANCY:

The fabric comes with a 5-year guarantee and a life expectancy of 10 - 15 years. The framework has a life expectancy of up to 25 years, depending on the chosen finish.

SIZE:

Can span up to 4 metres x 4 metres.

FRAMEWORK:

The canopy frame can be galvanised for ultimate corrosion protection and/or powder coated to any RAL colour of your choice.

DESIGN:

Unique cantilever design.

FABRIC:

The tensile fabric has an unmatched strength with a weight of 590gsm and is available in 40 vibrant colours including metallic finishes, see page 125 for more details. It is 100% waterproof.

UV PROTECTION:

High UV protection.

OPTIONAL EXTRAS:

› Post pads
See page 125

USES:

- › Play canopy
- › Covered outdoor seating area
- › Shaded storytelling area
- › Medium freestanding canopy
- › Shaded waiting area



Windsor

Tensile Fabric Structures



Residential



Education



Hospitality
& Leisure



Retail &
Commercial



Healthcare

The Windsor is an attractive steel canopy that is covered with waterproof tensile fabric, which is available in 16 vibrant colours. It has a modern and fun design and is ideal for enabling your pupils to play and learn outside all year round whilst keeping them protected from the weather.

The steel frame benefits from integral guttering and downpipes for a seamless, streamlined appearance. It is supplied galvanised and powder coated in a choice of 25 standard RAL colours.

Features and Benefits

SIZE:
Available from 4m x 4m up to 9m x 9m.

FRAMEWORK:
The frame is constructed from 150mm x 100mm steel box sections and 150mm x 150mm posts, however this will change depending on the size of the structure.

GUTTERING:
Supplied with integral guttering for ease of maintenance and sleek appearance.

FABRIC:
The fabric is waterproof 650g/sm PVC that is lacquered on both sides for a high gloss appearance and also offers high UV protection from the sun.

FABRIC GUARANTEE:
The Fabric has a 5 year guarantee and a life expectancy of 15 years. The steel frame has a 10 year guarantee, both are subject to terms and conditions.

COLOUR OPTIONS:
The steel frame is supplied galvanised and is powder coated in a choice of 25 RAL colours. The fabric is available in a choice of 16 colours.

- OPTIONAL EXTRAS:**
- > Post pads
 - See page 125
 - > Roller shutters
 - > Lighting
 - > Heating
 - > Skylights
 - > PVCu walls and glazing
 - > Terrace screens
 - > Seating and bins

- USES:**
- > Outdoor play
 - > Outside learning
 - > Al fresco dining
 - > Events shelter



Evershade

Tensile Fabric Structures



Residential



Education



Hospitality
& Leisure



Retail &
Commercial



Healthcare

The Evershade is a steel framed waterproof tensile structure that is perfect for organisations who would like a waterproof shade sail but at a lower cost.

This product is popular with the Education, Hospitality, Sports & Leisure sectors. Restaurants and cafés use this product often to provide covered alfresco dining areas – maximising their seating capacity.

The Evershade is a contemporary fabric structure that has a striking design that will enhance any outside environment. It is a well-designed steel canopy that is covered with commercial grade, waterproof tensile fabric. We have also introduced reinforced webbing to the edges of the fabric for additional strength.

Features and Benefits

25 YEAR LIFE EXPECTANCY:

A 25 year life expectancy depending on the chosen finish.

SIZE:

Supplied in modular squares from 3m x 3m to 6m x 6m, multiple squares can be added together to cover larger areas.

FRAMEWORK:

The frame is constructed from 150mm x 150mm steel box sections.

FABRIC & UV PROTECTION:

The tensile fabric is UV stabilised offering the highest UV protection. It blocks up to 99% of the sun's harmful UV rays.

COLOUR OPTIONS:

The frame is supplied in Hipca White as standard and is available in any other RAL colour at an additional cost. The fabric is available in 40 different colours.

OPTIONAL EXTRAS:

- > Post pads
- See page 125
- > Seating

USES:

- > Outdoor play
- > Outdoor learning
- > Alfresco dining
- > A study canopy
- > Time-out shelter



Drayton Umbrella

Tensile Fabric Structures



Residential



Education



Hospitality
& Leisure



Retail &
Commercial



Healthcare

The Drayton is our classic umbrella that is suitable for outdoor eating and drinking areas, patios, play-areas, decking or any other outdoor setting, the Drayton is constructed with a high quality aluminium frame and state-of-the-art gearbox which is guaranteed for 5 years.

There's a wide range of fabrics to choose from and the fabric can be branded with a logo, image or slogan of your choice.

Depending on individual requirements, the Drayton can be installed using concrete foundations with in-ground sleeves, base plates or portable bases. Stainless steel fixings are also available for coastal or marine environments.

Features and Benefits

SIZE:

Supplied in a choice of 3 shapes and a range of sizes:

Round: up to 6m diameter

Square: up to 5m x 5m

Rectangle: up to 6.5m x 4m

SYSTEM:

Can be opened and closed with a crank drive handle which is very smooth.

FRAMEWORK:

The frame is made from extruded aluminium and is supplied in white as standard. Other non-standard RAL colours are available on request.

FABRIC:

Available with a choice of two fabrics; acrylic and polyester which are available in a total of 47 different colours.

GUARANTEE:

The frame is supplied with a 1 year guarantee and the crank gearbox is supplied with a 5 year guarantee.

OPTIONAL EXTRAS:

- > Post pads
- See page 125
- > Branding
- > Seating

USES:

- > Alfresco dining
- > Outdoor learning
- > A study canopy
- > Relaxation/time-out shelter



Richmond Umbrella

Tensile Fabric Structures



Residential



Education



Hospitality
& Leisure



Retail &
Commercial



Healthcare

The Richmond is a strong and sturdy umbrella that is suited to windy locations such as seaside pubs and restaurants. It has been wind tunnel tested and is TÜV approved (German Technical Inspection Association) and is suitable for wind speeds of up to 102 km/h.

It has a contemporary design that can be round, square or rectangular and can cover areas up to 50 square metres. The umbrella can be opened and closed easily with the hand crank supplied (which can be removed to avoid tampering once open) making it ideal for those that would like a structure that is not permanently open.

Features and Benefits

SIZE:

Supplied in a choice of 3 shapes and a range of sizes:

Round: Up to a maximum of 8m

Square: Up to a maximum of 6m

Rectangle: Up to a maximum of 7.5 x 4m

SYSTEM:

Can be opened and closed with a crank drive handle which can be removed to avoid pupils/customers tampering with it once open.

FRAMEWORK:

The frame is made from extruded aluminium and is supplied in white as standard. Other non-standard RAL colours are available on request.

FABRIC:

Available with a choice of two fabrics; acrylic and polyester which are available in a total of 47 different colours.

GUARANTEE:

The frame is supplied with a 1 year guarantee and the crank gearbox is supplied with a 5 year guarantee.

OPTIONAL EXTRAS:

- > Post pads
- See page 125
- > Branding
- > Heating
- > Lighting
- > Side panels
- > Rain gutters
- > Seating
- > Stainless steel fixings are available for coastal and marine environments

USES:

- > Hotel canopy
- > Restaurant canopy
- > Outside bar shelter
- > Shelter at visitor attractions
- > Outdoor play-areas
- > A picnic canopy



Kendal

Tensile Fabric Structures



Education



Hospitality
& Leisure



Retail &
Commercial



Healthcare

The Kendal Cantilevered Walkway is a stunning freestanding walkway system which has a smooth contemporary appearance.

This canopy is constructed from a robust steel frame which is covered with waterproof tensile fabric, creating a stylish walkway system which is ideal for many sectors including the Education sector and the Hospitality and Leisure industry.

Features and Benefits

SIZE:

Available in 3 metre, 4 metre and 5 metre widths with an unlimited length.

FRAMEWORK:

The canopy frame is available galvanised and/or powder coated to a RAL colour of your choice.

FABRIC:

100% Waterproof tensile roof - available in 40 vibrant colours including metallic finishes, see page 125 for more details.

UV PROTECTION:

Offers high UV protection.

OPTIONAL EXTRAS:

- > Tensile side panels
 - > Post pads
- See page 125

USES:

- > Play canopy
- > Covered walkway
- > Outdoor classroom
- > Freestanding canopy
- > Waiting canopy

Features and Benefits

Tensile Fabric

- › 100% waterproof
- › Unmatched strength with a weight of 590gsm
- › Consistently smooth finish which is easy to maintain
- › High UV protection with 5 year guarantee against UV degradation.
- › This fabric is supplied with the Ulverston, Dallington and Keswick umbrellas, and Evershade and Kendal canopies.



Tensile Fabric Colour options

Standard options



Additional options



Fabric Options & Optional Extras

Tensile Fabric Structures

Post Pads

Our post pads are a popular choice for schools and nurseries as they provide protection from everyday knocks and bumps. They can be fitted to all our Shade Sails and contain the finest non absorbent foam to offer superb protection. They also feature fixing straps and drain holes to maximise the life of the post pads.

Post Pad Colour Options



Rainbow Package

Our Rainbow Package will brighten up your canopy structure and is very popular within nurseries, pre-schools and primary schools. This vibrant package includes a colourful uPVC banner and post pads. The Rainbow Package is available with the Codale, Codale Junior and Windsor tensile canopies.

Tensile Side Panels

Tensile side panels are available on a selection of our tensile structures, including the Codale and Kendal. These side panels help to shelter occupants from the wind and create a more enclosed canopy.



10

Our range of commercial retractable awnings shade unwanted heat and light from your building's interior, helping to keep your office or classroom cool whilst cutting down on the need for expensive air conditioning.

Our awnings also provide temporary cover for external areas, allowing you to provide shade on hot sunny days.

Popular applications include: providing shelter for smoking areas, shade for outdoor eating and seating areas and providing much needed shade in Early Years' play areas.

Due to their durable and robust construction, all our awnings are suited to the rigours of any commercial setting, including restaurants, schools, nurseries and care homes.

Commercial Awnings

Palladio
Australia
Pergolino







Palladio

Commercial Awnings



Residential



Education



Hospitality
& Leisure



Retail &
Commercial



Healthcare

The Palladio is a stylish awning which retracts into a compact cassette when not in use. The neat design ensures the Palladio is unobtrusive but can be easily and quickly extended to create a cooling shade during hot, sunny weather.

High quality design ensures smooth and reliable operation of the flyer chain within the arm. We also ensure the fabric is stretched evenly by using special tensioning mechanisms.

Features and Benefits

GUARANTEE:

- › Each Palladio awning is supplied with a 2 year guarantee against manufacturing defect.

WIDE RANGE OF COLOURS:

- › Choose from our extensive range of colours. Standard colours can be found on page 131, for additional colours please visit our website.

OPTIONAL AUTOMATIC DRIVE:

- › Choice of electronic operation with a remote control or manual operation with a hand crank.

FABRIC PROTECTION:

- › Our unique design means our awnings are tightly rolled and completely protected inside the cassette.

THERMAL GLUING OF FABRICS:

- › The fabric is bonded together with a modern hot glue technique using only the highest quality PUR-based reactive glue.

OPTIONAL: VARIO VOLANT:

- › Vario Volant is a roll-down blind which is discreetly concealed in the front section of the awning. It provides protection against the low sunset and guarantees privacy and comfort. It can be used both with the Palladio and Australia awnings.

SIZE:

- › Length: Up to 5.5m
- › Width: Up to 3.6m



Semi-round bar



Australia

Commercial Awnings



Residential



Education



Hospitality
& Leisure



Retail &
Commercial



Healthcare

The Australia awning fits seamlessly into any setting, creating shade and shelter when needed the most. It can also be configured with an added feature of being able to adjust the inclination of the awning, which is useful depending on the angle of the sun at different times of the day.

The Australia is a popular choice for all environments due to its elegantly simple design and robust construction.

By creating a shaded and sheltered outdoor area, you can protect your expensive garden furniture which can quickly deteriorate if left to the elements.

Features and Benefits

GUARANTEE:

- › Each Australia awning is supplied with a 2 year guarantee against manufacturing defect.

WIDE RANGE OF COLOURS:

- › Choose from our extensive range of colours. Standard colours can be found on page 131, for additional colours please visit our website.

MANUAL/ELECTRONIC OPERATION:

- › Choose from manual operation with a hand crank or electronic operation with a remote control.

R-PITCH:

- › R-Pitch is an additional option for the Australia awning which enables the inclination of the awning to be manually adjusted with the use of a crank.

THERMAL GLUING OF FABRICS:

- › The fabric is bonded together with a modern hot glue technique using only the highest quality PUR-based reactive glue.

OPTIONAL: VARIO VOLANT:

- › Vario Volant is a roll-down blind which is discreetly concealed in the front section of the awning. It provides protection against the low sunset and guarantees privacy and comfort. It can be used both with the Palladio and Australia awnings.

SIZE:

- › Length: Up to 7m
- › Width: Up to 3.6m.





Pergolino

Commercial Awnings



Residential



Education



Hospitality
& Leisure



Retail &
Commercial



Healthcare

The Pergolino provides protection from bright sunshine as well as light rain and is the ideal solution for restaurants, bars and cafes as well as domestic properties.

Due to its high quality and robust construction using the best components, the Pergolino is a very stable structure.

Features and Benefits

GUARANTEE AND WARRANTY:

- › Each Pergolino awning comes with a 2 year guarantee, 5 years warranty on fabric and 5 years on Somfy motors.

COMFORT AND PROTECTION:

- › Summer rain will never again surprise the guests of your restaurant or family at a weekend barbecue. You may enjoy additional space around your home, protected from sun and rain.

WIDE RANGE OF COLOURS:

- › You can choose from a vast range of colours depending on whether you want the awning to blend in, or contrast with the existing architecture and surroundings. Standard colours can be found on page 131 and for additional colours please visit our website. The frame is available powder coated in 3 different RAL colours including: Pure White (RAL 9010), White Aluminium (RAL 9006), and Anthracite Grey (RAL 7016).

THERMAL GLUING OF FABRICS:

- › The fabric is bonded together with a modern hot glue technique using only the highest quality PUR-based reactive glue.

SIZE:

- › Length: Up to 5m
- › Width: Up to 5m





Standard Colours

For Palladio, Australia and Pergolino Awnings

Dickson Colour Range:

Composition:	Acrylic 100%, solution dyed
Finishing:	Cleangard special dirt-resistant and awning water repellent treatment
Weight: 290g/m2 Width:	120cm
Tensile Strength:	140 daN Wrap / 90 daN Weft
Tear Strength:	4 daN Wrap / 2.3 daN Weft
Water Repellency:	>370mm
Colour Fastness Weather Condition:	4-5 / 5



Standard options

								
TITANE ORC-U408	NATUREL ORC-7133	ACIER PIQUE ORC-U406	GRIS ORC-6088	PIERRE ORC-6196	PERLE ORC-7972	PLATINE PIQUE ORC-U407	BASALTE CHINE ORC-U095	BORDEAUX ORC-8206
								
DUNE ORC-0681	SOURIS ORC-8396	FLANELLE ORC-U104	ARDOISE ORC-8203	NOIR ORC-6028	CARBONE ORC-U171	CHARCOAL TWEED ORC-7330		

11

Our shelter range includes steel and timber cycle, waiting and buggy shelters and large steel compounds. From the purely functional to the stunningly stylish, we are sure to have the ideal solution for you.

Shelters & Compounds

Langdale
Grasmere
Witton Wall Mounted
Witton Free Standing
Easydale
Coniston

Ainsley
Denver
Pembroke
Meadley
Easydale







Langdale

Cycle & Waiting Shelters



Residential



Education



Hospitality
& Leisure



Retail &
Commercial



Healthcare

The Langdale Shelter has a contemporary design which provides an attractive shelter solution, ideal for colleges and schools, town and city centres and shopping centres.

Available as a waiting or cycle shelter, the Langdale utilises our unique clamping system on the edge of the shelter which dramatically reduces the need to drill holes, thereby avoiding water leakage and unsightly distortion of the panels.

Features and Benefits

- › Standard size: 4.2 metres length x 3 metres depth
- › Standard sized shelter will hold 10 cycles or seating for 12 adults plus standing room
- › Unique clamping system
- › Robust steel construction fitted with 5mm polycarbonate sheets
- › True modular design allowing you to easily extend the shelter size in the future
- › Up to 25 year life expectancy, depending on the chosen finish
- › Supplied galvanised and/or powder coated in a range of standard colours.

ROOF RAFTER BARS:

Aluminium rafter bars are finished in Hipca White as standard, other colours are available at an additional cost.

OPTIONAL EXTRAS:

- › Available BREEAM compliant, please ask for details.





Grasmere

Cycle & Waiting Shelters



Residential



Education



Hospitality
& Leisure



Retail &
Commercial



Healthcare

The Grasmere can be installed as a cycle shelter or a waiting shelter, with a standard shelter holding up to 10 cycles or seating for 6 people with additional standing room.

Constructed from a robust steel framework, it is available with a choice of polycarbonate or timber panelling with a corrugated steel roof. Polycarbonate panelling creates a clean, simple finish which allows for all round visibility into the shelter, whilst timber cladding creates a stylish, contemporary look to your bike storage area.

The Grasmere is also available as a bin shelter, for more information see page 147.

Features and Benefits

- › Standard size: 4.1 metres length x 2.1 metres depth x 2.3 metres height
- › Standard 2-bay shelter can be fitted with 5 cycle racks or seating for 6 adults
- › Unique clamping system
- › Robust steel construction fitted with 5mm polycarbonate sheets, or timber cladding with corrugated steel roofing
- › True modular design, extensions without drilling and welding
- › Up to 25 year life expectancy
- › Base plate fixing to existing concrete foundation
- › Supplied galvanised and/or powder coated in a range of standard colours
- › Ideal for overlooked areas with or without CCTV
- › Available cladded in 5mm solid polycarbonate or timber panelling which is available in a choice of different timbers including Western Red Cedar Wood.

OPTIONAL EXTRAS:

- › Standard lockable gates
- › BREEAM compliant design available on request. Please ask for details





Witton Wall Mounted

Cycle & Waiting Shelters



Residential



Education



Hospitality
& Leisure



Retail &
Commercial



Healthcare

The Witton Wall Mounted Shelter has a sleek, modern look and is ideal for schools with limited space for cycle parking or waiting shelters.

The unique clamping system holds the edge of the 5mm solid polycarbonate sheeting in place which dramatically reduces the need to drill holes, thereby avoiding water leakage and unsightly distortion of the panels.

The Witton Wall Mounted Shelter measures 4.2m x 2.1m and can be extended by 2.1m bays.

Features and Benefits

- › Standard size: 4.2 metres length x 2.1 metres depth x 2.1 metres height (at the front)
- › A standard 2 bay shelter can be fitted with 5 cycle racks to accommodate 10 bicycles, or seating for 6 adults
- › Unique clamping system
- › Robust steel construction
- › True modular design, extensions can be easily added without drilling and welding
- › Clear view 5mm polycarbonate roof panels
- › Up to 25 year life expectancy
- › Base plate fixing to existing concrete foundation
- › Supplied galvanised and/or powder coated in a range of standard colours.

ROOF RAFTER BARS:

Aluminium rafter bars are finished in Hipca White as standard, other colours are available at an additional cost.

OPTIONAL EXTRAS:

- › Polycarbonate side panels
- › BREEAM compliant design available on request. Please ask for details.





Witton Free Standing

Cycle & Waiting Shelters



Residential



Education



Hospitality
& Leisure



Retail &
Commercial



Healthcare

The Witton Free Standing Shelter has a unique and eye-catching look to provide an attractive cycle parking or waiting shelter solution which is particularly suited to modern urban settings.

The Witton Free Standing Shelter measures 4.2m x 4.2m and can hold up to 20 bikes or seating for 12 adults, with additional standing room.

Features and Benefits

- › Standard size: 4.2 metres length x 4.2 metres depth x 2.2 metres height (at the front)
- › Standard sized shelter can hold 20 cycles or seating for 12 adults plus standing room.
- › Unique clamping system
- › Robust steel construction
- › True modular design, extensions can be easily added without drilling and welding
- › Clear view 5mm polycarbonate roof panels
- › Up to 25 year life expectancy
- › Base plate fixing to existing concrete foundation
- › Supplied galvanised and/or powder coated in a range of standard colours.

OPTIONAL EXTRAS:

- › Polycarbonate side panels
- › BREEAM compliant design available on request. Please ask for details.





Easydale

Cycle & Waiting Shelters



Residential



Education



Hospitality
& Leisure



Retail &
Commercial



Healthcare

The Easydale is our most cost-effective shelter because of its simple design. The Easydale has a robust steel and polycarbonate construction which can be adapted to offer secure cycle parking or a comfortable waiting area. Due to its slim-line design, this shelter is ideal for organisations that have limited space yet need the maximum possible parking or seating capacity.

The Easydale Shelter can also be installed with 2 secure buggy bars to make a secure buggy shelter. For more information please see page 146.

Features and Benefits

- › Size: 4.1 metres length x 1.7 metres depth x 2.1 metres height
- › Standard 2-bay shelter can hold 10 cycles or seating for up to 6 adults
- › Robust steel construction fitted with 5mm polycarbonate sheets
- › True modular design, extensions added without drilling and welding
- › Up to 25 year life expectancy, depending on the chosen finish
- › Base plate fixing to concrete foundation
- › Supplied galvanised and/or powder coated in a range of standard colours.

OPTIONAL EXTRAS:

- › Polycarbonate side panels
- › Available BREEAM compliant, please ask for details.



Coniston

Cycle & Waiting Shelters



Residential



Education



Hospitality
& Leisure



Retail &
Commercial



Healthcare

The Coniston Wall Mounted Canopy can be utilised as a cost effective cycle shelter by combining it with secure cycle racks.

The Coniston is a heavy duty aluminium structure which is fitted with 35mm structured polycarbonate panels and can be constructed to any length to cover any number of cycle racks.

Features and Benefits

- › Fitted with 35mm polycarbonate panels that are light in weight and up to 200 times stronger than glass and 10 times stronger than uPVC panels
- › Constructed from aluminium with heavy duty structural aluminium roof bars - for ultimate strength
- › Framework is finished in Hipca White as standard, however it can be powder coated to any standard colour on request
- › Up to 25 year life expectancy.

OPTIONAL EXTRAS:

- › Polycarbonate side panels
- › Available BREEAM compliant, please ask for details.



Ainsley

Cycle & Waiting Shelters



Residential



Education



Hospitality
& Leisure



Retail &
Commercial



Healthcare

The Ainsley is a contemporary cycle & waiting shelter that features clear polycarbonate or glass panels which are fixed to the steel frame with glass locks for a sleek appearance. With its understated, yet striking design, the Ainsley is the perfect cycle shelter for a range of settings including town centres, schools and colleges, retail outlets, leisure and commercial sites.

The steel frame is available galvanised, giving it a life expectancy of up to 25 years. You can choose to have it powder coated in any standard RAL colour of your choice, non-standard RAL colours are available at an additional cost.

Features and Benefits

- › Unlimited Length: The shelter is available in any length with a maximum depth of up to 5m
 - › The main frame is constructed from strong steel sections that are available galvanised and/or powder coated in standard RAL colour of your choice, non-standard RAL colours are available at an additional cost
 - › Enclosed with a choice of 5mm solid polycarbonate, 16mm structured polycarbonate or 8mm toughened glass that is secured in place with glass locks. As an alternative the shelter can be covered with corrugated steel roof sheets
 - › Supplied with guttering and uPVC downpipes as standard
 - › The frame is supplied with a 25 year life expectancy, depending on the chosen finish.
- OPTIONAL EXTRAS:**
- › Cycle racks
 - › Benches
 - › Front glass panels



Denver

Timber Cycle & Waiting Shelters



Residential



Education



Hospitality
& Leisure



Retail &
Commercial



Healthcare

The Denver Timber Shelter features a simple curved design that offers a compact cycle or waiting shelter solution, ideal for customers with limited space.

Its Glulam construction creates an attractive shelter which looks great in green environments such as parks and wildlife areas; it also makes a stylish addition to urban environments.

Features and Benefits

- › Standard shelter size: 4.2 metres length x 1.6 metres width x 2.1 metres height
- › A standard 2-bay shelter can be fitted with 5 cycle racks to accommodate 10 bicycles, or seating for up to 6 adults
- › Has an attractive curved roof/back panel design which is achieved through the use of Glulam timber
- › 5mm polycarbonate panels to provide complete protection from the weather
- › Steel feet to prevent rot at ground level. Feet are also adjustable to allow shelters to be fitted to uneven ground.





Pembroke

Timber Cycle & Waiting Shelters



Residential



Education



Hospitality
& Leisure



Retail &
Commercial



Healthcare

The Pembroke Timber Shelter has an expertly designed framework which features curved posts and a curved roof to create a striking shelter structure.

This contemporary shelter design has 8 cycle hoops as standard which can park up to 16 cycles or benches which seats up to 8 adults. Due to its open design there is easy access to the shelter, which is ideal for public areas such as shopping centres or public parks and gardens.

Features and Benefits

- › Standard shelter size: 4.7 metres length x 3 metres width x 2.6 metres height
- › Standard sized shelter will hold up to 16 cycles or seating for 8 adults plus standing room
- › High quality Glulam construction incorporating curved posts and roofing to create a modern styled shelter
- › 5mm or 16mm polycarbonate panels to provide excellent cover from the weather
- › Steel feet to prevent rot at ground level. Feet are also adjustable to allow shelters to be fitted to uneven ground.





Ainsley

Shopping Trolley Shelters



Residential



Education



Hospitality
& Leisure



Retail &
Commercial



Healthcare

Make your shopping centre or retail outlet stand out with the elegantly designed Ainsley Trolley Shelter.

The Ainsley is constructed from the highest quality materials including a strong steel frame that is available galvanised and powder coated in any standard RAL colour. It is covered with a choice of toughened glass panels or clear polycarbonate panels.

The Ainsley is the perfect shelter for keeping your trolleys dry and organised in a neat and tidy designated area.

Features and Benefits

- › Unlimited Length: The shelter is available in any length with a maximum depth of up to 5m
- › The main frame is constructed from strong steel sections that are available galvanised and/or powder coated in standard RAL colour of your choice, non-standard RAL colours are available at an additional cost
- › Enclosed with a choice of 5mm solid polycarbonate, 16mm structured polycarbonate or 8mm toughened glass that is secured in place with glass locks. As an alternative the shelter can be covered with corrugated steel roof sheets.
- › Supplied with guttering and uPVC downpipes as standard
- › The frame is supplied with a 25 year life expectancy, depending on the chosen finish.

OPTIONAL EXTRAS:

- › Cycle racks
- › Benches
- › Front glass panels



Ainsley

Bus Shelters



Residential



Education



Hospitality
& Leisure



Retail &
Commercial



Healthcare

The Ainsley Bus Shelter provides the ultimate weather protection, keeping individuals dry whilst waiting outside.

It features a strong steel frame that is available galvanised and powder coated for extra weather resistance. You can choose from any standard RAL colour of your choice to match your branding colours (non-standard RAL colours are available at an additional cost). The shelter is enclosed with a choice of toughened glass or polycarbonate panels which are both completely clear.

Features and Benefits

- › Unlimited Length: The shelter is available in any length with a maximum depth of up to 5m
- › The main frame is constructed from strong steel sections that are available galvanised and/or powder coated in standard RAL colour of your choice, non-standard RAL colours are available at an additional cost
- › Enclosed with a choice of 5mm solid polycarbonate, 16mm structured polycarbonate or 8mm toughened glass that is secured in place with glass locks. As an alternative the shelter can be covered with corrugated steel roof sheets
- › Supplied with guttering and uPVC downpipes as standard
- › The frame is supplied with a 25 year life expectancy, depending on the chosen finish.

OPTIONAL EXTRAS:

- › Cycle racks
- › Benches
- › Front glass panels



Meadley

Buggy Shelters



Residential



Education



Hospitality
& Leisure



Retail &
Commercial



Healthcare

The Meadley Buggy Box provides a safe and secure place to store buggies. It is manufactured from steel with vandal and shatter resistant polycarbonate panels and is available as a single and double shelter.

The Meadley is available with secure lockable doors, which can be secured with the use of a padlock.

Features and Benefits

- › Robust steel construction
- › True modular design, extensions added without drilling and welding
- › Fitted with 5mm solid vandal and shatter resistant polycarbonate sheeting
- › Base plate fixing to your existing concrete area
- › Up to 25 year life expectancy, subject to chosen finish
- › Supplied galvanised and/or powder coated in a range of standard colours.

Buggy Box Capacity

SINGLE BUGGY BOX

- › Standard size: 2050mm length x 1200mm depth x 1200mm height
- › Can hold up to 4 buggies

DOUBLE BUGGY BOX

- › Standard size: 4060mm length x 1200mm depth x 1200mm height
- › Can hold up to 8 buggies

OPTIONAL EXTRAS:

- › Secure lockable doors



Easydale

Buggy Shelters



Residential



Education



Hospitality
& Leisure



Retail &
Commercial



Healthcare

The Easydale Buggy Shelter is our most cost-effective buggy shelter because of its simple, yet stylish design. It is the perfect shelter solution for safe, secure storage for buggies and prams, keeping them protected from theft, vandalism and poor weather conditions.

The Easydale Buggy Shelter is ideal for use in nurseries and pre schools, providing a secure space for parents and staff to store buggies during the day.

A standard shelter measures 4.1 metres x 1.7 metres and can be extended by 2 metre modular bays, as required.

Features and Benefits

- › Supplied with buggy bars for secure pram parking
- › Available with hinged doors as an optional extra for added security
- › Adjustable feet: beneficial when installing to existing concrete surfaces
- › Base plate fixing to your existing concrete area.
- › Fitted with 5mm solid polycarbonate roof panels available in clear or opal
- › Steel frame is available galvanised and/or powder coated in a range of standard colours
- › High UV protection – helps prevent the colour of the prams fading due to the sun's UV rays
- › Up to a 25 year life expectancy, subject to chosen finish.

OPTIONAL EXTRAS:

- › Hinged lockable doors



Grasmere

Bin Shelters



Residential



Education



Hospitality
& Leisure



Retail &
Commercial



Healthcare

The Grasmere Bin Shelter is a cost-effective storage solution for large industrial refuse or recycling bins. It can also be used for storing a large amount of domestic sized bins.

This shelter is an ideal solution if you need to protect against vandalism and bad weather, ensuring a safer, cleaner environment. Manufactured to meet your requirements, the Grasmere can be fitted with lockable doors which can be secured with the use of a padlock, swipe card or key fob.

Features and Benefits

- › Standard size: 4.1 metres length x 2.1 metres width, this shelter can be easily extended by 2 metre bays
- › Ideal for overlooked areas with or without CCTV
- › Standard 2 bay design can fit a maximum of 6 standard 240 litre bins or 2 standard 1100 litre bins
- › Up to a 25 year life expectancy, subject to chosen finish.
- › Fitted with 5mm solid polycarbonate panels, available in clear or opal
- › **OPTIONAL EXTRAS:**
- › Steel corrugated roof which can be powder coated to a choice of colours
- › Hinged lockable gates
- › Unique clamping system around the edge of the shelter to avoid water leakage
- › Framework can be supplied galvanised and/ or powder coated in a range of standard RAL colours

12

Aluminium Decking is an eco-friendly, long-lasting alternative to traditional style decking such as timber or composite.

Our standard and balcony decking boards are fire resistant and are A2-s1, d0 fire rated. This means that they meet the required fire safety regulations that were recently implemented for balconies on residential buildings.

The boards feature a 100% aluminium construction, the slip resistant boards also feature rubber inserts. Up to 30% of the aluminium used in the boards are made from recycled aluminium billets. The aluminium can also be recycled again and again, making it an extremely durable and long-lasting decking option.

Aluminium Decking

Standard Decking
Slip Resistant Decking
Fire Resistant Balcony Decking
Flat Fire Resistant Balcony Decking
Rooftop Terrace Decking
Supa Joist







Standard Decking

Aluminium Decking



Residential



Education



Hospitality
& Leisure



Retail &
Commercial



Healthcare

Able Canopies' Standard Alideck is a quick-to-install all aluminium decking system that can be installed 50% quicker than other decking systems on the market.

The aluminium construction makes this a fully fire resistant decking solution. The untreated boards have an A1 rating which is the best fire rating possible however, our boards are treated with a durable powder coating giving them a fire rating of A2-s1, d0 which is the second best possible fire rating, both options have no contribution to fire.

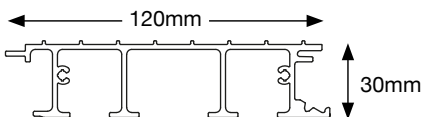

Features and Benefits

10 YEAR WARRANTY:

- › Supplied with a 10-year warranty against corrosion and UV degradation and a 50-year life expectancy.

BOARD SIZE:

- › Length: 6 metres
- › Width: 120mm
- › Depth: 30mm

POSSIBLE DECKING AREA SIZE:

- › Unlimited

FINISH:

- › Finished with a heavy-duty powder coating finish which is available in textured grey and textured sand.

CONSTRUCTION MATERIAL:

- › 100% aluminium (30% of which is recycled aluminium).

FIRE RESISTANCE:

- › A2-s1, d0 fire rating.

RECYCLABLE:

- › The aluminium boards are 100% recyclable.

OPTIONAL EXTRAS:

- › Integrated lighting
- › Joist to leg brackets
- › Alideck end plates

USES:

- › Outdoor dining areas
- › Walkways
- › Terraces
- › Patios





Slip Resistant Decking

Aluminium Decking



Residential



Education



Hospitality
& Leisure



Retail &
Commercial



Healthcare

Our Slip Resistant Aluminium Decking is a strong and durable aluminium decking system which features rubber slip resistant inserts, making it perfect for use in commercial settings.

The high-quality construction of aluminium with QUALICOAT powder coating and rubber inserts, makes it ideal for use in well-used areas such as restaurants, bars and hotels.

If you are looking to make an environmentally friendly choice with your purchase, you will be pleased to discover that the decking is made from 30% recycled aluminium billets and all of the aluminium can be recycled over and over again.

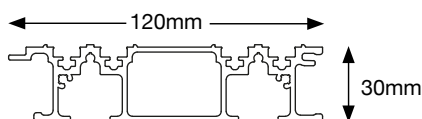

Features and Benefits

10 YEAR WARRANTY:

- › Supplied with a 10-year warranty against corrosion and UV degradation and a 50-year life expectancy.

BOARD SIZE:

- › Length: 6 metres
- › Width: 120mm
- › Depth: 30mm

POSSIBLE DECKING AREA SIZE:

- › Unlimited

FINISH:

- › Finished with a heavy-duty powder coating finish which is available in textured grey and textured sand.

CONSTRUCTION MATERIAL:

- › 100% aluminium (30% of which is recycled aluminium).

RECYCLABLE:

- › The aluminium boards are 100% recyclable.

OPTIONAL EXTRAS:

- › Integrated lighting
- › Joist to leg brackets
- › Alideck end plates

USES:

- › Education
- › Residential
- › Hospitality & leisure
- › Retail & commercial
- › Healthcare

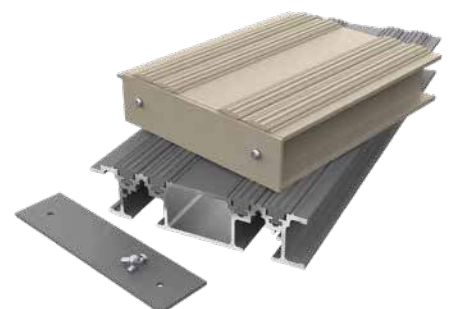



Balcony Decking

Aluminium Decking



Residential



Hospitality
& Leisure



Retail &
Commercial



Healthcare

In the recent years, there has been a lot of awareness focused on the need for improved fire safety products used on buildings, including balconies. So much so that new regulations have been brought in that ban the use of combustible materials in external wall systems and balconies in residential buildings.

Our aluminium balcony decking is manufactured from aluminium which makes it naturally fire resistant and non-combustible. They are class A2-s1, d0 fire rated and are noncombustible.

This fire-resistant balcony decking is light in weight, yet high in load-bearing capacity meaning it requires less supporting steelwork than heavier materials, thereby significantly reducing costs.

Features and Benefits

10 YEAR WARRANTY:

- › Supplied with a 10-year warranty against corrosion and UV degradation and a 50-year life expectancy.

BOARD SIZE:

- › Length: 4 & 6 metres
- › Width: 120mm
- › Depth: Choice of 20mm and 30mm
- › Each plank can be cut to size along the width to fit the designated area.

POSSIBLE DECKING AREA SIZE:

- › Unlimited

FINISH:

- › Finished with a heavy-duty powder coating finish which is available in textured grey and textured sand.

CONSTRUCTION MATERIAL:

- › 100% aluminium (30% of which is recycled aluminium).

FIRE RESISTANCE:

- › Powder Coated: A2-s1, d0

RECYCLABLE:

- › The aluminium boards are 100% recyclable.

USES:

- › Residential Balconies
- › Commercial Balconies

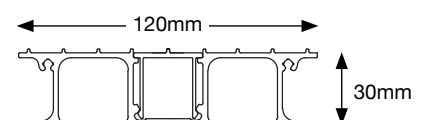



Flat Balcony Decking

Aluminium Decking



Residential



Hospitality
& Leisure



Retail &
Commercial



Healthcare

The Flat Balcony Decking Boards feature the same specification as the Balcony Decking Boards on the opposite page, yet they have a flatter surface which is much more pleasant to walk upon when barefoot. This makes the decking ideal for domestic installations such as high-rise flats, student accommodation and high-end apartments which feature balconies.

The boards are available in two different sizes; 30mm deep and 20mm deep, both boards feature the same length of 6m and width of 120mm. They are fire resistant to A2-s1, d0 which means they meet the government requirements for materials used on balconies in residential buildings. They are also supplied with a 10-year warranty and a minimum 50-year life expectancy.

Features and Benefits

10 YEAR WARRANTY:

- › Supplied with a 10-year warranty against corrosion and UV degradation and a 50-year life expectancy.

BOARD SIZE:

- › Length: 4 & 6 metres
- › Width: 120mm
- › Depth: Choice of 20mm and 30mm
- › Each plank can be cut to size along the width to fit the designated area.

POSSIBLE DECKING AREA SIZE:

- › Unlimited

FINISH:

- › Finished with a heavy-duty powder coating finish which is available in textured grey and textured sand.

CONSTRUCTION MATERIAL:

- › 100% aluminium (30% of which is recycled aluminium).

FIRE RESISTANCE:

- › Powder Coated: A2-s1, d0

RECYCLABLE:

- › The aluminium boards are 100% recyclable.

USES:

- › Residential Balconies
- › Commercial Balconies

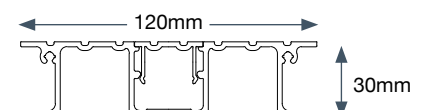
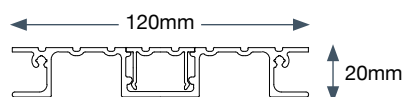



Rooftop Terrace Decking

Aluminium Decking

More and more professionals within the construction industry are looking to secure suppliers for non-combustible products and rightly so. Our range of Alideck aluminium decking boards and supports are the ideal product to use on roof top terrace decking areas.

We have developed a quick-to-install, non-combustible aluminium decking system which can be adjusted to the height required for your project. This non-combustible, aluminium rooftop terrace decking has been calculated and is structurally safe to withstand high loads while alternate decking options on the market will need additional underside supports.

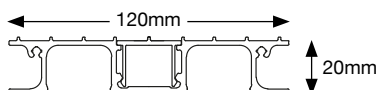

Features and Benefits

10 YEAR WARRANTY:

- › Supplied with a 10-year warranty against corrosion and UV degradation and a 50-year life expectancy.

BOARD SIZE:

- › Length: 4 & 6 metres
- › Width: 120mm
- › Depth: Choice of 20mm and 30mm
- › Each plank can be cut to size along the width to fit the designated area.

POSSIBLE DECKING AREA SIZE:

- › Unlimited

FINISH:

- › Finished with a heavy-duty powder coating finish which is available in textured grey and textured sand.

CONSTRUCTION MATERIAL:

- › 100% aluminium (30% of which is recycled aluminium).

FIRE RESISTANCE:

- › Powder Coated: A2-s1, d0

RECYCLABLE:

- › The aluminium boards are 100% recyclable.

USES:

- › Residential Rooftop Terraces
- › Commercial Rooftop Terraces

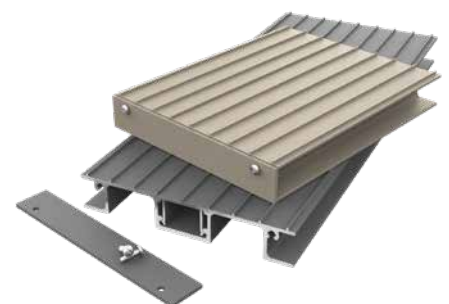



Supa Joist

Aluminium Decking



Residential



Education



Hospitality
& Leisure



Retail &
Commercial



Healthcare

The Alideck Supa Joist is an aluminium joist that has been designed as a standalone product to be used with our aluminium decking systems. It complements the systems and enables super-fast installation times. It can also be used as a standalone solution and can be used in conjunction with composite and timber decking options.

This all aluminium system is unique and modular, so it can be extended to any length, it can also be simply connected together to create double the span depending on the desired foundation spacings.

Traditional support structures are manufactured from timber which normally requires a joist every 400mm. One of the advantages of the Supa Joist, is that when used with the Alideck system, it only requires

Features and Benefits

10 YEAR WARRANTY:

- › Supplied with a 10-year warranty against corrosion and UV degradation and a 50-year life expectancy.

QUICK INSTALLATION

- › Because less joist are required (only every 400mm), the installation time is therefore much quicker.

FINISH:

- › Finished with a heavy-duty powder coating finish which is available in textured grey and textured sand.

CONSTRUCTION MATERIAL:

- › 100% aluminium (30% of which is recycled aluminium).

installing every 1900mm or 1200mm (depending on the loadings that are required). This results in much quicker installation times, and because it's made from aluminium, it will never need maintenance.

FIRE RESISTANCE:

- › Powder Coated: A2-s1, d0

RECYCLABLE:

- › The aluminium boards are 100% recyclable.

USES:

- › Education
- › Residential
- › Hospitality & leisure
- › Retail & commercial
- › Healthcare

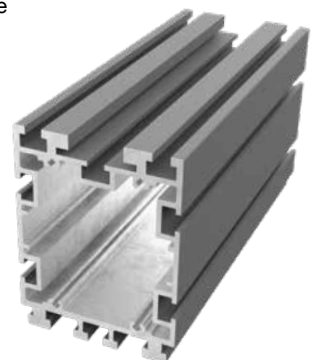

13

If you are looking to renovate your school or commercial outdoor area, we can take care of the project for you from start to finish depending on your product requirements.

Alongside our canopies, shelters, shade sails and awnings, we also offer additional services to complete your outdoor project such as external surfacing, fire resistant aluminium decking and fencing. We can take the stress out of dealing with multiple suppliers, so you only liaise with us.

When installed together, our range of outdoor products create the ultimate covered outdoor areas, providing you with shade and shelter from the elements as well as a fresh, new outside setting that you will want to use all day, every day.

Outdoor Projects

Artificial Grass
Soft Play Safety Surfacing
Tarmac
Aluminium Decking
Commercial Fencing

How Our Projects Service Could Help You

Each of our installations involve project management. Coordinating start times, deliveries and the hand over process, all take planning and communication. These skills allow us to look at the requirements of each project and widen our responsibilities to include more elements of the installation and the management of more trades.

Our skilled people can negotiate the best prices, source the right products and co-ordinate all the elements to avoid clashes and wasted time.

What that means for you is one point of contact, one source for all the elements that you need to complete your project, one invoice to pay and a lot of time and money saved.

External Surfacing

If you are renovating your outside area, we can supply and install your external surfacing, as part of your canopy package. All our surfacing options are commercial grade products that are designed for everyday use in busy areas. They are long lasting products, many of which are supplied with guarantees so you can rest assure that your outdoor area will last for many years.



Artificial Grass

Artificial Grass enables you to keep a natural appearance whilst keeping the area low maintenance and mud-free. Our artificial grass is a premium product which has a realistic appearance, it resembles real turf by touch and appearance.



Soft Play Safety Surfacing

Soft Play provides your school or establishment with an impact absorbing safety surface where children play and learn, reducing the risk of grazes and bumps when playing around and falling over. It is slip-resistant, which reduces the risk of children falling over in the first place.



Tarmac

We can tarmac the surface of your external grounds as part of your canopy package. Whether you require a small amount of tarmacking to make good around your canopy, or you would like a large area covered around your canopy, we can supply and install to meet your requirements.

Aluminium Decking

Aluminium Decking is a fire-resistant, eco-friendly and long-lasting alternative to traditional style decking such as timber or composite. We have designed a number of aluminium decking systems to suit all requirements, please see pages 148-155 for the full range.



Standard Decking

Our Standard aluminium decking is a quick-to-install all aluminium decking system that can be installed 50% quicker than other decking systems on the market. See page 150 for further details.



Slip Resistant Decking

Our Slip Resistant Decking is a strong and durable aluminium system which features rubber slip resistant inserts, making it perfect for use in commercial settings. See page 151 for further details.



Balcony Decking

Our aluminium balcony decking system is manufactured from aluminium which makes it naturally fire resistant and non-combustible. It is light in weight yet has a high in load-bearing capacity. See page 152 for further details.

Commercial Fencing

Steel and timber fencing systems can be used to enclose your canopy to create a safe, designated area for pupils, staff or visitors to reside within. We currently offer three types of fencing which include Steel Mesh Fencing, Steel Palisade Fencing and Timber Fencing.



Steel Mesh Fencing

Our mesh fencing is available in 8 different options including: Sports Mesh, Sports Rebound Mesh, VGuard Mesh, Secure Guard + Mesh, Secure Guard 358 Mesh, Pro Gard Mesh, Twin Guard Mesh and Fast Guard Mesh.



Steel Palisade Fencing

Palisade fencing is a high security fence system that reduces the risk of trespassers from entering your grounds. It also helps to keep those inside such as school pupils, deterring them from climbing the fences.



Timber Fencing

Timber fencing is a great way to enclose your canopy or outside area to create a designated area whilst also keeping a natural appearance, perfect for leafy areas.





Able Canopies
Canopies, Shelters and
Outdoor Projects from
the UK Canopy Experts

Index

A

Abberton Entrance Canopy	72
Ainsley Bus Shelter	144
Ainsley Cycle & Waiting Shelter	140
Ainsley Entrance Canopy	68
Ainsley Shopping Trolley Shelter	143
Albedo Effect Solar Canopy	92
Aluminium Decking	148-155
Ashton Wall Mounted Canopy	18-19
Australia Awning	129

B

Balcony Decking	152
Balmoral Entrance Canopy	76
Beck Entrance Canopy	63
Bespoke Canopies	102-105
Bioclimatic Pergolas	82-87
Blenheim Umbrella	117

C

Codale Conic Tensile Fabric Structure	114
Codale Junior Tensile Fabric Structure	115
Colwyn Entrance Canopy	81
Commercial Awnings	126-131
Commercial Fencing	157
Coniston 6 Wall Mounted Canopy	16-17
Coniston Cycle & Waiting Shelter	139
Coniston Free Standing Canopy	47
Coniston Walkway	53
Coniston Wall Mounted Canopy	10-15

D

Dallington Umbrella	118
Denver Timber Cycle & Waiting Shelter	141
Design and Build Bespoke Canopies	104
Devoke Free Standing Canopy	28
Devoke Junior Free Standing Canopy	29
Devoke Junior Free Standing Walkway	57
Double Grange Large Span Canopy	45
Drayton Umbrella	122

E

Earlswood Entrance Canopy	70
Easydale Buggy Shelter	146
Easydale Cycle & Waiting Shelter	138
Ennerdale Junior Free Standing Walkway	56
Entrance Canopies	60-81
Evershade Tensile Fabric Structure	121
External Surfacing	157

F

Fabric Options - Awnings	131
Fabric Options - Shade Sails	110
Fabric Options - Tensile Fabric Structures	125
Fenwick Entrance Canopy	78
Ferndale Entrance Canopy	73
Flat Balcony Decking	153
Free Standing Canopies	24-47

G

Glass Bespoke Canopies	105
Grange Apex Solar Canopy	97
Grange Free Standing Canopy	30
Grange Free Standing Walkway	58
Grange Junior Free Standing Canopy	31
Grange Junior Free Standing Walkway	59
Grange Mono-Pitch Solar Canopy	94
Grasmere Bin Shelter	147
Grasmere Cycle & Waiting Shelter	135

H

Hamilton Large Span Canopy	46
----------------------------	----

I

Imperial Grand Bioclimatic Pergola	85
Imperial Senior Bioclimatic Pergola	84

K

Kendal Tensile Free Standing Canopy	36
Kendal Tensile Fabric Structure	124
Kensington Dual-Pitch Free Standing Canopy	35
Kensington Dual-Pitch Solar Canopy	101
Kensington Junior Entrance Canopy	65
Kensington Mono-Pitch Free Standing Canopy	34
Kensington Mono-Pitch Solar Canopy	98
Kensington Wall Mounted Entrance Canopy	64
Keswick Umbrella	119

L

Langdale Cycle & Waiting Shelter	134
Large Span Canopy Range	43
Lexden Entrance Canopy	77

Index

M	
Meadley Buggy Shelter	145

N	
Nelson Entrance Canopy	79

O	
Optional Extras - Bioclimatic Pergolas	86-87
Optional Extras - Shade Sails	111
Optional Extras - Tensile Fabric Structures	125
Optional Extras - Wall Mounted & Free Standing Canopies	48-49
Orwell Entrance Canopy	69
Outdoor Projects	156-157

P	
Palladio Awning -	128
Pembroke Timber Cycle & Waiting Shelter	142
Pergolino Supported Awning	130
Redford Entrance Canopy	71

R	
Richmond Umbrella	123
Rooftop Terrace Decking	154

S	
Shade Sails	106-111
Shelters and Compounds	132-147
Slip Resistant Aluminium Decking	151
Solar Canopies	88-101
Standard Aluminium Decking	150
Supa Joist (Aluminium Decking)	155

T	
Tamworth Entrance Canopy	75
Tarnhow Curved Free Standing Timber Canopy	42
Tarnhow Curved Wall Mounted Timber Canopy	23
Tarnhow Dome Free Standing Timber Canopy	40
Tarnhow Dome Large Span Timber Canopy	44
Tarnhow Mono-Pitch Free Standing Timber Canopy	41
Tarnhow Mono-Pitch Wall Mounted Timber Canopy	22
Tenby Entrance Canopy	80
Tensile Fabric Structures	112-125
Timber Free Standing Canopies	39
Timber Wall Mounted Canopies	20-23
Tintern Entrance Canopy	74

U	
Ullswater Apex Free Standing Canopy	32
Ullswater Entrance Canopy	62
Ullswater Free Standing Walkway	52
Ulverston Umbrella	116

W	
Walkway Canopies	50-59
Wall Mounted Canopies	8-23
Welford Dome Entrance Canopy	67
Welford Dome Free Standing Canopy	26
Welford Dome Free Standing Walkway	54
Welford Dome Junior Free Standing Canopy	27
Welford Dome Junior Free Standing Walkway	55
Whiteside Entrance Canopy	66
Whiteside Free Standing Canopy	33
Windsor Tensile Fabric Structure	120
Witton Free Standing Cycle & Waiting Shelter	137
Witton Wall Mounted Cycle & Waiting Shelter	136

Please call.
We're here to help.

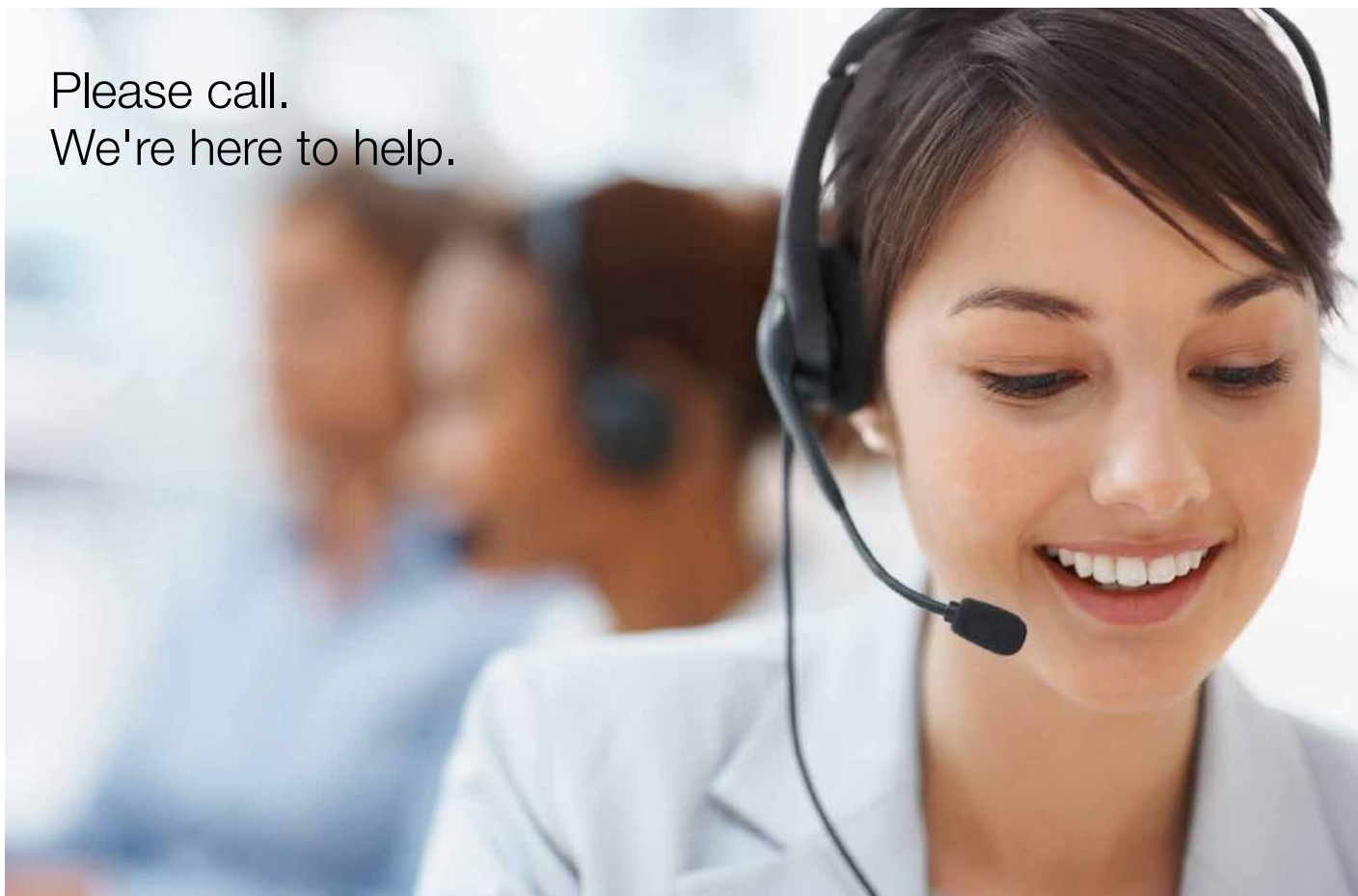

How to order

Contact us



0800 389 9072

Call us and speak to our friendly sales advisors who will be happy to discuss your needs in detail, book a site survey, or organise a quick estimate for you.



01255 425 541

Fax us. Once we receive your enquiry one of our team will contact you as soon as possible to assist you further.



sales@ablecanopies.co.uk

Send us an email. Your email will be passed to the correct person who can help with your specific enquiry and we'll do our best to respond within 2 working days.





Our Address

If you prefer to write to us please send your letter to:

Able Canopies Ltd
Head Office
9-11 Faraday Close
Gorse Lane Industrial Estate
Clacton-on-Sea
Essex CO15 4TR



www.ablecanopies.co.uk

You can contact us via our 'Contact Us' form on our website. You can also view detailed information on all our products and order any of our Accessories directly from our website.



Free Site Survey

We offer a free no-obligation site survey to qualifying customers who enquire about a canopy, shelter, shade sail or awning. Our surveyor will visit your site at a time most convenient for you, to discuss your requirements in depth and assess your site. This allows us to provide you with a firm quotation based on your exact requirements. Contact us today to see if you qualify.



- Wall Mounted Canopies <
- Entrance Canopies <
- Free Standing Canopies <
- Executive Canopies <
- Walkways <
- Solar Canopies <
- Bespoke Canopies <
- Able Shade Sails <
- Tensile Fabric Structures <
- Commercial Awnings <
- Shelters & Compounds <

Design, manufacture and installation of Canopies, Shade Systems and Shelters

Head Office
 9-11 Faraday Close
 Gorse Lane Ind. Estate
 Clacton-on-Sea
 Essex CO15 4TR

0800 389 9072
sales@ablecanopies.co.uk
www.ablecanopies.co.uk

